

Trimble Survey Controller™

Help

Version 12.22
Revision A
April 2008



Table of Contents

General Operations	1
Welcome.....	1
The Trimble Survey Controller Screen.....	1
Files Menu.....	1
Status Bar.....	2
Status Line.....	4
Customizing the Startup Screen.....	4
Trimble CU and Trimble VX/S Series Keys.....	5
Trimble TSC2 Function Keys.....	6
Controller Keyboard Functions.....	6
Trimble Survey Controller Buttons.....	9
Entering Quadrant Bearings.....	10
Calculator.....	10
Time/Date.....	12
Sound Events.....	13
Language.....	13
Windows Explorer / File Explorer.....	13
Trimble Controller - General Operation.....	14
Using Bluetooth technology to print from a Trimble TSC2 controller.....	17
Power Indicators.....	19
Attaching and Detaching Trimble CU Controller.....	20
Registration.....	20
Legal Notices.....	21
About.....	21
Troubleshooting.....	21
Job Repair Wizard.....	25
Job Operations	26
Job.....	26
File management and Project folders.....	27
Properties of Current Job.....	29
Review Current Job.....	30
Point Manager.....	32
QC Graph.....	38
Storing Points.....	39
Map of Current Job.....	41
Filter.....	43
Using the Map for Common Tasks.....	44
Autopan.....	48
Units.....	48
Linked Files.....	49
Active Map.....	51
Using a Feature and Attribute Library.....	54
High Accuracy GIS.....	59
Using Description Fields.....	61

Table of Contents

Job Operations

Copy Between Jobs.....	62
------------------------	----

Key In.....64

Key in Menu.....	64
Key in - Points.....	64
Key in - Lines.....	64
Key in - Arcs.....	65
Key in - Alignments.....	69
Key in - Roads.....	70
Trimble roads.....	71
Horizontal Alignment.....	72
Entry by Length / Coordinates.....	72
Entry by End station.....	74
Entry by PI.....	76
Vertical Alignment.....	77
Entry by Vertical Points of Intersection (VPI).....	78
Entry by start and end points.....	79
Template Positioning.....	80
Roading Template - Example Alignment.....	81
Superelevation and Widening.....	84
Templates.....	85
Station equations.....	87
Group strings.....	87
New string.....	88
Key in - Notes.....	89
Tunnel: Key in.....	90
Tunnel: Horizontal Alignment.....	91
Tunnel: Entry by Length.....	91
Tunnel: Entry by End station.....	93
Tunnel: Entry by End coordinates.....	95
Tunnel: Vertical Alignment.....	96
Tunnel: Entry by Vertical Points of Intersection (VPI).....	97
Tunnel: Entry by Start and End Points.....	98
Tunnel: Template Positioning.....	99
Tunnel: Templates.....	100

Cogo.....102

Cogo Menu.....	102
Cogo - Compute Inverse.....	103
Cogo - Compute Point.....	103
Cogo - Compute Area.....	109
Cogo - Compute Azimuth.....	109
Cogo - Compute Distance.....	112
Cogo - Compute Average.....	113

Table of Contents

Cogo

Cogo - Subdivide a line.....	114
Cogo - Subdivide an arc.....	115
Taped distances.....	118
Cogo - Transformations.....	119
Cogo - Traverse.....	120
Pop-Up Menu Controls.....	122
Cogo Settings.....	122

Survey - General.....128

Survey Menu.....	128
Getting Started.....	128
Getting Connected.....	129
Integrated Surveying.....	130
GPS Surveys.....	130
Conventional Surveys.....	131
Measure Points.....	138
Measure Codes.....	140
Roading.....	144
Tunnels.....	145
Stakeout - Overview.....	145
Fast Fix.....	146
Topo Point.....	147
Check Point.....	148
End Survey.....	149

Survey - Conventional.....150

Measuring topo points in a Conventional Survey.....	150
Station Setup.....	152
Station setup plus.....	154
Measuring Rounds in Station setup plus or Resection.....	158
Station Elevation.....	161
Resection.....	162
Reflines.....	166
Measure Rounds.....	167
Station setup plus, Resection, and Rounds Options.....	174
Continuous topo - Conventional.....	177
Scanning.....	178
Surface Scan.....	183
Station and offset.....	185
Averaged Observations.....	186
Angle Offset, H. Angle Offset, and V. Angle Offset.....	186
Distance Offset.....	187
Dual-prism Offset.....	189
Circular object.....	189

Table of Contents

Survey - Conventional	
Remote Object.....	190
Conventional Instrument - Corrections.....	190
Target Details.....	192
Prism Constant.....	196
Measuring a Point in Two Faces.....	197
GDM CU Programs.....	199
Advanced Geodetic Support.....	202
Angles and distance.....	202
Survey - Calibration.....	203
Calibration.....	203
Configuring the Survey Style for a Site Calibration.....	204
Calibration - Manual.....	205
Calibration - Automatic.....	206
Survey - GPS.....	209
Starting the Base Receiver.....	209
Base Options.....	216
Setting Up the Equipment for a Trimble R8, R6 or 5800 GPS Survey.....	217
Rover Options.....	222
Measuring Antenna Heights.....	224
Antenna.ini File.....	227
RTK Initialization Methods.....	227
RTK Survey.....	230
Operating Several Base Stations on One Radio Frequency.....	233
Starting a Real Time Survey Using a Dial-in GSM connection.....	234
Starting a Real Time Survey Using a GPRS internet connection.....	235
Redialing the Base Station.....	236
Starting a Wide-Area RTK Survey.....	236
RTK and Infill Survey.....	237
RTK and Data Logging.....	238
FastStatic Survey.....	239
PPK Survey.....	240
PP Initialization Times.....	241
RT Differential Survey.....	242
Wide Area Augmentation System (WAAS) and European Global Navigation Overlay Service (EGNOS).....	243
Rapid Point.....	244
Continuous Topo.....	244
FastStatic Point.....	245
Observed Control Point.....	246
RTK On Demand.....	247

Table of Contents

Survey - Integrated.....	249
Integrated Surveys.....	249
IS rover - Integrated survey rod.....	252
Survey - Stakeout.....	254
Stakeout - Configuring the Display Mode.....	254
Stakeout - Using the Graphical Display.....	256
Stakeout - Options.....	257
As-Staked Point Details.....	258
Stakeout - Points.....	261
Stakeout - Lines.....	262
Stakeout - Arcs.....	265
Stakeout - Alignments.....	269
Stakeout - Digital Terrain Models (DTM).....	273
Stakeout - Roads.....	275
Exporting GENIO files from 12D Model.....	277
Staking Trimble Roads.....	277
Trimble roads - Station and offset.....	278
Stakeout - Available Stations.....	280
Selecting a New Offset for a Side Slope.....	281
Position relative to a Trimble road.....	282
Nearest offset.....	283
Staking out a Side Slope Relative to an Alignment.....	285
Staking Roads from GENIO Files.....	286
Group strings.....	287
Exclude Master at stakeout.....	288
New Strings.....	289
Position relative to GENIO road.....	290
Stakeout along a string.....	291
Stakeout station on string.....	292
Staking relative to a secondary road.....	294
String interpolation.....	295
Staking Roads from LandXML Files.....	296
Specifying Construction Offsets.....	297
Cross Section View.....	300
Catch Point.....	301
Catch Point Staked Deltas.....	302
Defining a cross slope.....	303
Defining a subgrade.....	303
Fine and Coarse Modes - GPS Stakeout.....	304
Survey - Tunnels.....	305
Tunnel: Overview.....	305
Importing Tunnels.....	305
Auto Scanning Positions in a Tunnel.....	306

Table of Contents

Survey - Tunnels	
Manually Measuring Positions in a Tunnel.....	308
Reviewing Tunnels.....	309
Survey Configuration.....	310
Configuration Menu.....	310
Survey Styles.....	310
Software Options.....	311
Survey Types.....	313
Conventional Instrument - Configuration.....	313
Conventional Instrument - Type.....	316
Laser Rangefinder.....	321
Duplicate Point Tolerance.....	323
Feature and Attribute Library.....	325
Radios - for GPS.....	327
Cellular Modem - Overview.....	330
Dial Profiles.....	331
Cellular Modem Dial-in Survey Configuration.....	332
Cellular Modem Internet Survey Configuration.....	335
Connecting to the Internet.....	338
Bluetooth.....	341
Transferring files between controllers.....	347
Instruments.....	350
Instrument Menu.....	350
Satellites.....	351
Receiver Files.....	353
Position.....	354
Receiver Status.....	354
Receiver Settings.....	354
Navigate to Point.....	354
Network / Reference Station Status.....	355
Station Setup Details.....	355
Laser pointer.....	355
Electronic Level.....	356
Direct Reflex.....	357
Turn to.....	358
Joystick.....	359
Video.....	360
Tracklight.....	364
Autolock.....	364
GPS Search.....	369
Instrument Settings.....	372
Radio Settings.....	373
Instrument Adjustment.....	375

Table of Contents

Instruments	
Trimble Survey Controller Basic.....	377
Trimble Functions.....	378
GDM Data Output.....	379
Coordinate System.....	381
Coordinate System.....	381
Customizing the Coordinate System Database.....	381
Scale Factor Only.....	383
Projection.....	383
Ground Coordinate System.....	384
Project Height.....	385
No Projection / No Datum.....	385
Horizontal Adjustment.....	385
Vertical Adjustment.....	386
Coordinate Systems.....	386
Options Softkey.....	394
Coordinate View Settings.....	396
Projection Grids.....	396
Shift Grids.....	397
File Transfer.....	398
Import / Export menu.....	398
Transferring Files between the Controller and the Office Computer.....	398
Sending and Receiving ASCII Data Between External Devices.....	409
Import and Export Fixed Format Files.....	414
Export Custom Format Files.....	416
Import Custom Format Files.....	419
Email.....	420
Database Search Rules.....	425
Database Search Rules.....	425
Appendix A.....	433
Calculations performed by the Trimble Survey Controller software.....	433
Transformations applied to GPS positions.....	433
Ellipsoid Calculations.....	440
Conventional Instrument Calculations.....	440
Standard Errors Recorded With Conventional Observations.....	446
Area Calculations.....	447
Glossary.....	448
Glossary.....	448

General Operations

Welcome

Welcome to the Trimble Survey Controller software version 12.22 Help.

This help system makes it easy to find the information you need to effectively use the full power and capabilities of the Trimble Survey Controller software.

For information that extends or updates this Help, refer to the Trimble Survey Controller Getting Started Guide and Release Notes. Alternatively, visit the Trimble website (www.trimble.com) or contact your local Trimble dealer.

The Trimble Survey Controller Screen

For an explanation of the buttons and icons on the Trimble Survey Controller screen, see:

[Status Bar](#)

[Status Line](#)

[Trimble Survey Controller Buttons](#)

[Shortcut Keys \(TCU\)](#)

[TSC2 Keys](#)

[About Trimble Survey Controller](#)

Files Menu

Use this menu to view and manage jobs, and transfer data between the office computer and external devices.

For more information, see:

[New job](#)

[Open job](#)

[Review current job](#)

[Review tunnel](#)

[Point manager](#)

[QC Graph](#)

[Map of current job](#)

[Properties of current job](#)

[Copy Between Jobs](#)

[Import/Export](#)

[Windows Explorer / File Explorer](#)













Status Bar







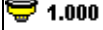

















The status bar is located on the top right side of the Trimble Survey Controller screen. Which icons it displays depends on the equipment that is connected to the controller. Tap an icon to view more information about that equipment.

In a conventional survey, tap the instrument icon to access Trimble functions, or tap the target icon to change targets or target details.

In a GPS survey, tap the satellite icon to view the Sky plot.

The following table describes the status bar icons.

Icon	What it shows
	Controller is connected to and drawing power from an external supply.
	Controller is connected to an external power supply and is recharging the internal battery.
 100% or  50%	Power level is 100% or 50%. If this icon is on the top, it refers to the controller battery. If the icon is below the controller battery, it refers to the power level of an external device.
	A 5800 receiver is in use.
	A Trimble R7 receiver is in use.
	A Trimble R8 receiver is in use.
	A 5700 GPS receiver is in use.
	A 4800 GPS receiver is in use.
	A 4700 GPS receiver is in use.
 1.000	A 4800 GPS receiver is in use. The antenna height is shown to the right of the icon.
	An external antenna is in use. The antenna height is shown to the right of the icon.

	A conventional instrument is in use. If a station setup is completed, the instrument height is shown to the right of the icon.
	A conventional instrument is being used to measure a point.
	A conventional instrument is receiving an EDM signal back from the prism.
	A conventional instrument is locked on to the target (prism).
	A conventional instrument is locked and measuring to the target (prism).
	A conventional instrument in FastStandard (FSTD) mode averages the angles while a fast standard measurement is taken.
	A conventional instrument in Standard (STD) mode averages the angles while a standard distance measurement is taken.
	A conventional instrument in Tracking (TRK) mode constantly measures distances and updates in the status line. (TRK is commonly used in stakeout and continuous topo.)
	The laser pointer is on (DR mode only).
	The radio signals from the robotic instrument are no longer being received.
	The height of a conventional target is shown to the right of the icon. "1" indicates that target 1 is in use.
	The prism is locked by the robotic instrument. The prism constant (in millimeters) and target height are shown to the right of the icon. "1" indicates that target 1 is in use.
	The target icon changes to a DR icon to show that the instrument is in Direct Reflex mode.
	The target icon rotates to show that the conventional instrument has Autolock enabled but is not currently locked on to a target.
	GPS Search is enabled.
	A static point is being measured.
	Radio signals are being received.
	Cellular modem signals are being received.
	When the cellular modem hangs up, or stops receiving corrections, the icon appears with a cross through it.
	WAAS/EGNOS signals are being received.
	Continuous points are being measured.
	If no survey is running, the number of satellites being tracked is shown to the right of the icon. If a survey is running, the number of satellites in the solution is shown to the right of the icon.
	A real-time survey is running and base data from a network connection is being streamed to the rover.
	Real-time base data streaming from a network connection is paused. Base data streaming automatically restarts when required.
	A real-time survey with base data from a network connection is stopped. The base station network connection is maintained, but the real-time base data will not be streamed to the

	rover.
	A real-time survey is running but base data from a network connection cannot be received.

Status Line

The status line is displayed on the bottom of the screen. It displays a message when an event or action occurs, and when the Trimble Survey Controller software cannot start or continue with its present function.

When the controller is connected to a receiver, the status line displays the current survey mode. The following table explains these modes.

Survey mode	Explanation
No Survey	The receiver is connected but a survey has not been started.
RTK:Fixed	The current RTK survey is initialized, and the solution type is L1 fixed-centimeter-level.
RTK:Float	The current RTK survey is not initialized, and the solution type is L1 float.
RTK:Check	The current RTK survey is verifying the initialization.
RTK:Auto	The radio link is down in the current RTK survey, and the solution is an autonomous position.
RTK:WAAS	The radio link is down in the current RTK survey, and the solution is a WAAS/EGNOS position
FastStatic	The current survey type is FastStatic.
PPK:Fixed	The current postprocessed kinematic survey is initialized and, when postprocessed, should yield an L1 fixed or an iono-free (centimeter-level) solution.
PPK:Float	The current postprocessed kinematic survey is not initialized and, when postprocessed, should yield an L1 float solution.
PP differential	The current survey type is postprocessed differential.
RT differential	The current survey type is real-time differential.
Infill:Fixed	The current kinematic infill survey is initialized and, when postprocessed, should yield an L1 fixed or an iono-free (centimeter-level) solution.
Infill:Float	The current kinematic infill survey is not initialized and, when postprocessed, should yield an L1 float solution.
Infill	The current survey type is differential, and you are doing an infill session.
WAAS	The current survey type is differential, and using signals from the WAAS/EGNOS satellites.

The root mean square (RMS) indicator is displayed when you are in Fine mode in a real-time kinematic survey. It shows the RMS of the current position, expressed in millicycles.

Customizing the Startup Screen

You can customize the Trimble Survey Controller software startup screen to display an image of your choice.







1. Create your image 320 pixels wide x 240 pixels high, in the bitmap file format (*.bmp).

2. Save the file with the name [Startup_image.bmp], to the same folder on the controller as Survey.exe .
 - ◆ On a TSC2 controller: [\Program Files\Survey Controller].
 - ◆ On a Trimble CU controller: [\Program Files\Survey Controller].







When the Trimble Survey Controller software detects the file [Startup_image.bmp], it uses this file as the startup image, instead of the standard Trimble startup image.

Trimble CU and Trimble VX/S Series Keys

The following table describes the Trimble Survey Controller functions that are associated with the Trimble CU keys.

On this instrument or receiver...	tap...	to...
Conventional or GPS		change between 123, ABC, and abc keyboard entry modes
		modify the action of the other key that you tap in conjunction
		tab between fields
		activate the Enter button
Conventional		access the <i>Trimble functions</i> screen
GPS		access the position dialog

The following table describes the Trimble Survey Controller functions that are associated with the Trimble VX/S Series instrument keys when the controller is attached to the instrument and Trimble Survey Controller is running.

On the Trimble VX/S Series instrument press...	to...
 (short press)	activate the Enter button
 (long press)	power the instrument and controller on and off
 (short press)	change face
 (short press)	scroll between the face 1 view displays
 (long press)	switch the face 2 backlight on or off
 (short press)	activate the <i>Enter</i> button

When taking measurements the face 2 display shows the same measurement information as the view display button on the *Measure topo* and *Station setup* forms on face 1. This is typically horizontal angle, vertical angle and, after a measurement, the slope distance. To scroll through the different views, press the  key. Information such as current measurement status appears in the face 2 status line at the bottom of the display.



When a duplicate observation is encountered the face 2 display shows delta Horizontal angle, delta horizontal distance and delta vertical distance.

Note - Before you store the point, confirm the *Store as* action in the face 1 display.

Use the face 2 keys to control the instrument's onboard applications when the controller is not attached to the instrument. For more information, refer to the documentation for your instrument.

Trimble TSC2 Function Keys

The following table describes the Trimble Survey Controller software functions that are associated with the TSC2 controller keys.

Key	Function
	<p>If the Trimble Survey Controller software is not running, the Trimble button starts the software.</p> <p>If the Trimble Survey Controller software is running and the controller is connected to a conventional instrument, press the Trimble button to access Trimble functions.</p> <p>If the Trimble Survey Controller software is running and the controller is connected to a GPS receiver, press the Trimble button to access the <i>Position</i> form.</p>
	<p>You can customize the [Left App] button and the [Right App] button to perform your most used functions in the Trimble Survey Controller software.</p> <p>For details on how to set this up, see Customizing the App Buttons on a TSC2 Controller.</p>
	<p>The Ok button relates to the icon available at the top right corner of the screen.</p> <p>If the icon shows [Ok], then the Ok button saves and closes the form.</p> <p>If the icon shows an [X], tap the icon or the press the [Ok] button to hide the Trimble Survey Controller software.</p> <p>Note - If you tap [X] while the controller is connected to an instrument or GPS receiver, the connection is not broken when the Trimble Survey Controller software is hidden.</p>

Controller Keyboard Functions

The controller provides several additional keyboard functions that you can access through the operating system.

- [Numeric and Alphanumeric modes](#) (Trimble CU)
- [Input panel](#)
- [Transcriber](#)
- [Keyboard properties](#) (Repeat, Sticky keys, Key preview (Trimble CU), Backlight)

For more information on these functions, refer to the help. Tap *Start / Help*.

Numeric and Alphanumeric modes (Trimble CU)

Press the alpha key () to switch between numeric and alphanumeric modes. The current mode appears on the Windows taskbar and on the top right of the Trimble Survey Controller screen.

On the Trimble CU, when you press the alpha key, the controller scrolls through 123 - ABC - abc.

The Trimble Survey Controller software automatically sets the mode to numeric for numeric fields. For fields that can be either alpha or numeric, the software inspects the field and then does one of the following.

If the fields contains the following character type...	the software sets the field to...
alpha	alpha
numeric	numeric
alpha and numeric	match the last character in the field

Input panel

The input panel looks and functions like a PC keyboard. Use it as an alternative to the controller keyboard for entering characters.

To access the input panel through the taskbar icon ():

- Trimble CU: Tap the icon and then select the keyboard to display.
To close, tap the icon again and then select [Hide Input Panel].
- TSC2 controller that is running the Trimble Survey Controller software: Press and hold **Ctrl**, press 7 to display the input panel icon and then tap the icon.
To close, tap the icon again.
- TSC2 controller that is running a program other than the Trimble Survey Controller software: Tap the icon.
To close, tap the icon again.

To open or close the input panel through a keyboard shortcut:

- Trimble CU: Press and hold **Ctrl** and then press 7.

Transcriber

Transcriber recognises characters that you write on the controller screen with the stylus.

To enable the transcriber:

- ◆ TSC2 controller that is running the Trimble Survey Controller software: Press and hold **Ctrl** and then press 7. Tap the icon that appears at the center bottom of the screen, tap the arrow that appears beside it and then select [Transcriber] from the menu.

To start using the Transcriber, tap the Transcriber icon on the taskbar  . The icon appears with a white background.

- ◆ On a Trimble CU controller, tap [Start / Programs / Accessories / Transcriber].
The Transcriber icon on the taskbar  appears with a grey background.

To stop using Transcriber, tap the icon on the task bar. The icon background color changes. To start using again, tap the icon.

Note - When Transcriber is enabled, you need to tap and briefly hold screen buttons or icons to activate them. There is a slight delay while Transcriber determines if you are using the stylus to write with.

Keyboard properties

To set the following:

- ◆ On a TSC2 controller, tap [Start / Settings / Buttons / Keyboard Options].
- ◆ On a Trimble CU controller, tap [Start / Settings / Control panel / Keyboard].

Repeat

Repeat delay sets the time from when you first press a key to when the character starts repeating. Repeat rate sets the speed at which the character repeats.

On a TSC2 controller, tap [Start / Settings / Buttons / Up/Down Control] to access the delay and repeat configuration.

Sticky keys

Use this to access a hotkey sequence without having to press and hold a modifier key (**Alt**, **Ctrl**, or **Shift**) while you press the hotkey.

If Sticky keys is enabled, when you press a modifier key, that key 'sticks' until you press it again. For example, on the Trimble CU, use sticky keys to copy text (**Ctrl+C**) and paste text (**Ctrl+V**).

- ◆ Sticky keys enabled: Press **Ctrl**, and then press **8** three times (C). Press **Ctrl** and then press **2** three times (V).
- ◆ Sticky keys disabled: Press and hold **Ctrl** while you press **8** three times (C). Press and hold **Ctrl** while you press **2** three times (V).

Key preview (Trimble CU)

When the controller is in alpha mode, a popup window shows the active character. For example, if you press **8** four times, the key preview shows, in succession, a, b, c, 8.

Note - You do not need to wait for the previewed character to be accepted before you press another key, for example **Enter** or another character. When you press another key, the controller accepts the character that is currently in the preview window. This function enables you to enter characters faster.





Alternatively, shorten the key preview to speed up alpha character entry.

Backlight

- On a TSC2 controller, tap [Start / Settings / System / Backlight] to configure the backlight settings.
- On a Trimble CU controller, tap [Start / Settings / Control panel / Keyboard / Backlight] to enable or disable the keyboard backlight.

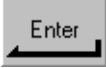
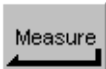
For more information on these functions, refer to the help. Tap *Start / Help*.

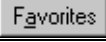
Trimble Survey Controller Buttons

 	<p>Tapping the <i>Enter</i> button on the controller is the same as tapping the Enter key on the controller keypad. The actions of the <i>Enter</i> button depend on the current screen. In some screens, the caption on the button changes to describe the action for the screen. For example, the <i>Enter</i> button changes to the <i>Measure</i> button when you are in the <i>Measure points</i> screen.</p>
	<p>Tap <i>Map</i> to display a map of the current job.</p>
	<p>Tap <i>Favorites</i> to access a list of commonly used screens. See the <i>Favorites</i> menu below.</p>
	<p>Tap this button to switch between active windows (screens).</p>

Note - The up arrow softkey appears if there are more than four softkeys associated with a screen. Tap the arrow or press the **Shift** key to see the other softkeys.

Tip - To highlight a field without selecting it, tap and hold briefly with the stylus.

Favorites menu

The *Favorites* menu provides quick access to commonly used screens and to various commands when connected to a conventional instrument or GPS receiver. Access a screen or command from the *Favorites* list, or use the *Switch to* button to access previously viewed screens.

To access a screen or command from the *Favorites* list, tap the *Favorites* button and then select the screen you want.

To add a screen to the Favorites list, view it and select *Favorites / Add to favorites*.

To add a command to the Favorites list:

1. Tap *Favorites / Customize / Add a command to Favorites menu*.
2. Tap the command you want to add.

To remove a command or form:

1. Tap *Favorites / Customize / Remove command from Favorites menu*.
2. Tap the item you want to remove.

Note - The commands that are available to be added to the *Favorites* menu vary depending on the Survey options you have set in *Configuration / Options*.

Customizing the App Buttons on a TSC2 Controller

The [Left App] button and the [Right App] button on the TSC2 controller provide quick access to commonly used screens or commands. To customize the [App] buttons:

1. Run the Trimble Survey Controller software.
2. If you want to assign a form to an [App] button, browse to that form. There are several instrument and GPS commands available by default.
3. From the main menu, tap *Favorites / Customize / Assign a command to App Button 1* or *Assign a command to App Button 2*
4. Select a function to assign it to the button.

Note - The options that are available to be assigned to the App buttons vary depending on the Survey options you have set in *Configuration / Options*.

Softkeys

Softkeys are displayed on the bottom line of the Trimble Survey Controller screen as on-screen buttons. They relate to particular screens and change when the screens change.

To access the softkeys using the keyboard:

- On a Trimble TSC2, press **Ctrl** and then **1, 2, 3,** or **4** for softkeys *F1, F2, F3,* or *F4* respectively. To display the second row of softkeys, press **Shift**.
- On a Trimble CU, press **Ctrl** and then **1, 2, 3,** or **4** for softkeys *F1, F2, F3,* or *F4* respectively. To display the second row of softkeys, press **Ctrl** and then **5**.

Entering Quadrant Bearings

1. Make sure the system units are quadrant bearings.
For more information, see [System Units](#).
2. Enter the bearing in any *Bearing* field.
3. Select NE, NW, SE, or SW from the popup list.
The quadrant bearing is inserted in the field.

Example

To enter the quadrant bearing N25° 30' 30"E in a bearing field:

- Key in **25.3030** .
- Select NE from the popup list.

Calculator



To perform a calculation from within a dialog field:

1. Select Calculator from the pop-up menu.
2. Enter the numbers and functions.
3. Tap = to calculate the result.
4. Tap Accept to return the result to the field.

To use the calculator at any time, select Cogo / Calculator from the main Trimble Survey Controller menu.

Tap (Options) to set the angle method, calculator mode (Reverse Polish Notation (RPN) or Standard), and decimal place display.

The calculator functions are shown below.

Calculator symbol	Function
+	Add
-	Subtract
x	Multiply
÷	Divide
+/-	Change sign of number being entered
=	Equals
π	Pi
	Enter
▼	Show all values on the stack
	Back space
<input checked="" type="checkbox"/>	Options
y^x	Raise Y to the power of X
x²	Square
√x	Square root
10^x	Raise 10 to the power of X
E±	Enter exponent or change exponent sign
1/x	Reciprocal
x↔y	Swap X with Y
SIN	Sine
SIN⁻¹	Arc Sin
COS	Cosine
COS⁻¹	Arc Cosine
TAN	Tangent
TAN⁻¹	Arc Tangent
LOG	Log base 10
SHIFT	Switch SHIFT state

{	Open parenthesis
}	Close parenthesis
C	Clear all
CE	Clear entry
Mem	Memory functions
P>R	Polar to rectangular coordinate conversion
R>P	Rectangular to polar coordinate conversion
R↓	Rotate stack down
R↑	Rotate stack up
° ' "	Insert degrees, minutes, or seconds separator
DMS-	Subtract angles of the form DD.MMSSsss
DMS+	Add angles of the form DD.MMSSsss
>D.dd	Convert from DD°MM'SS.sss or DD.MMSSsss to angle units
>DMS	Convert from current angle units to DD°MM'SS.sss

Time/Date

To set the time and date on a Trimble controller:

1. Do one of the following:

On a Trimble CU controller:

- ◆ Double-tap the clock on the right of the taskbar.

On a TSC2 controller:

- ◆ Tap [Start / Settings / System / Clock and Alarms].

2. Change the date and time as required. Press **Enter** to accept the new settings or **Esc** to cancel.

To configure the GPS time display setting:

1. From the main menu, select *Files / Properties of current job / Units*.
2. In the *Time format* field, select the required time display format.

A time stamp is stored with every record in the job and output to the DC file every 30 minutes.

Sound Events

Sound events are prerecorded messages that notify you of an event or action that has occurred. They correspond with status line messages, and common error and warning messages.

Sound events are stored as .wav files. You can customize your own sound events by replacing or deleting the existing .wav files located in the [Program Files\Survey Controller\Languages\English\] folder.

Tip - Use the Recorder application provided in the TSC2 controller to record your own sound events. Alternatively, transfer .wav files from the office computer to the controller using Data Transfer or the Microsoft ActiveSync technology.

To turn all sound events on or off:

1. From the main menu, select *Configuration / Controller / Sound events*.
2. Select the *Play sound events* check box to turn on sound events, or clear it to turn them off.

Language

To change the language of the Trimble Survey Controller software:

1. Use the Trimble Data Transfer utility to transfer a language file to the controller.
2. From the main menu of the Trimble Survey Controller software, select *Configuration / Controller / Language*.
3. Choose the required language from the list.
4. Restart the Trimble Survey Controller software.

Windows Explorer / File Explorer

Use Microsoft Windows CE Explorer to view and manage files stored in a Trimble CU controller.

To start Windows Explorer, tap [Start / Programs / Windows Explorer].

Use Microsoft Windows Mobile File Explorer to view and manage files stored in a TSC2 controller.

To start File Explorer, tap [Start / Programs / File Explorer].

For more information, refer to the Windows Help provided on the controller.

Deleting files

Use *Files / Open job* to copy and delete job files. If you delete job files, any associated GPS files are automatically deleted.

Use Microsoft Explorer to delete all other file types.

Warning - Files deleted in Explorer cannot be recovered.

Trimble Controller - General Operation

Use the links below to find out how to operate the controller:

[Configuring the Trimble Survey Controller shortcut on the TSC2](#)

[Calibrate the Touch Screen](#)

[Disable the Touch Screen](#)

[Use the keyboard to run programs](#)

[Perform a Soft Reset \(Warm boot\)](#)

[Perform a Hard Reset \(Cold boot\) - Trimble CU](#)

[Perform a Hard Reset \(Cold boot\) - TSC2](#)

[File Storage on Trimble Controllers](#)

[Change the speaker volume](#)

[Get rid of Out of Memory errors](#)

In addition, there are several [controller functions](#) that you can access through the keyboard.

Configuring the Trimble Survey Controller shortcut on the TSC2 controller

A shortcut to Trimble Survey Controller is available on the *Today* screen of the TSC2 controller.

To configure the shortcut:

1. Tap [Start / Settings / Personal / Today] and then select the [Items] tab.
2. As required, enable, disable, or move the position of the shortcut in the list and then tap [Ok] to save the changes.

An option on this shortcut allows you to automatically re-enable Bluetooth wireless technology after you reset the controller, as long as Bluetooth was turned on before the reset. For more information see, [Configuring Bluetooth to default to On after a reset](#)

Calibrate the Touch Screen

Trimble CU controller:

Open the Control Panel (**Ctrl, Esc, [Settings / Control Panel]**) then select the [Stylus] icon. In the [Stylus Properties] dialog select the [Calibration] >tab. Tap [Recalibrate] and follow the prompts, using the stylus to tap the target as it moves from the center of the screen, to each corner. If the calibration is successful, you are prompted to press **Enter** to accept the new settings. If the calibration was not successful, the target returns to the center of the screen and the process must be repeated.

TSC2 controller:

1. Tap [Start / Settings / System / Screen].
2. Tap [Align Screen] and follow the prompts. If the calibration is successful, the [Settings] screen appears at the end of the calibration process. If the calibration was not successful, the target returns to the center of the screen and you must repeat the process.

Disable the Touch Screen

To disable the Trimble TSC2 touch screen, press [Fn]+  key.

This disables the screen, but not the keypad. The touch screen will remain disabled until [Fn]+  key is pressed again or the controller is reset.

To disable the Trimble CU touch screen, press [Ctrl]+  key.

This disables the screen, but not the keypad. The touch screen will remain disabled until [Ctrl]+  key is pressed again or the controller is reset.

The touch panel disable notice can be disabled. To do this go to [Start / Settings / Control Panel], in the [Touch Pad Disable] tab of the [Stylus Properties] screen, clear the [Show notice each time touch is disabled] check box.

Use the keypad to run programs

To do this...	Use this keyboard shortcut...
Access a pull-down menu	Alt - then the appropriate letter key of the menu item.
Move between fields	Tab , up and down Arrow keys
Move between buttons	Arrow keys
Click a check box	Space Key
Close a screen	Alt then F then C
Switch between programs	Alt then Tab or Alt then Esc
Select an item from a list	Space key
Select a radio button	Space key

Use the keyboard to run programs, as follows :

- To run a program from the desktop:

If no desktop icons are highlighted, press the **Tab** key until one is selected. Then use the arrow keys to navigate to the icon for the program that you want to run. Press **Enter** to run the program.

- To run a program from the [Start] menu:

Press **Ctrl** then **Esc** to display the [Start] menu, then use the arrow keys to select [Programs]. Press **Enter** to display a list of programs, then use the arrow keys to select the program that you want to run. Press **Enter** to run the program.

- If there is no icon or [Start] menu listing:

If there are no icons highlighted on the desktop, press the **Tab** key until one is selected, then use the arrow keys to select [My Computer]. In [My Computer], use the arrow keys to highlight the Disk folder, then press **Enter**. Use the arrow keys to locate the program you want to run (it may be located in a sub folder), then press **Enter** to run the program.

Perform a Soft Reset (Warm boot)

You do not lose any data when you perform a soft reset.

- To soft reset the TSC2 controller, hold down the **Power** key. After about five seconds, a countdown timer appears, indicating that the controller will reset. Continue to hold down the **Power** key for a further five seconds, then release it. The controller briefly displays the boot screen and then resets to the default Microsoft Windows desktop view.
- To reset the Trimble CU, hold down the **Ctrl** key and the **1** key, then press and release the **9** key.

Perform a Hard Reset (Cold boot) on a Trimble CU controller

Perform a hard reset only if a soft reset fails to resolve an issue.

After a hard reset, the operating system is reloaded into RAM from the Flash memory. Some software programs may also store shortcuts or database information in RAM; this is erased during a hard reset.

To perform a hard reset, hold down the **Power** key. After about five seconds, a countdown timer appears, indicating that the controller will reset. Continue to hold down the **Power** key for a further five seconds, then release it. The controller briefly displays the boot screen and then resets to the default Microsoft Windows desktop view.

Perform a Hard Reset (Cold boot) on a TSC2 controller

You cannot perform a hard reset on a TSC2 controller. Perform a soft reset, and if that does not resolve the issues, contact your local Trimble dealer.

File Storage on Trimble Controllers

Trimble controllers have similar RAM and Flash storage.

In all controllers, the RAM storage is volatile and is shared between Storage memory and Program memory.

- Storage memory is required for such things as the Operating System, and installing programs.
- Program memory is required to run programs. When Program memory is low, programs may run slowly, become unresponsive, or even crash.

Flash memory is permanent, so data is not lost if the controller loses power or after a hard reset. However, as with a computer hard disk, this storage may occasionally fail.

- On the Trimble CU and TSC2, folders and files that appear in Explorer are those from Flash storage.

Get rid of Out of Memory errors

Trimble CU controller:

Open the Control Panel (**Ctrl, Esc, S, C**) then select the [System] icon. In the [System Properties] screen, select the [Memory] tab, then move the slider-bar to the left to increase the amount of RAM memory allocated to running programs.

TSC2 controller:

Memory is managed automatically. If you run out of memory, select [Start / Settings / System / Memory / Running Programs] and stop the running programs you no longer need.

Change the speaker volume

Trimble CU controller:

Open the Windows CE Control Panel (**Ctrl, Esc, S, C**) then select the Volume and Sounds icon. Use the slider to increase or decrease the volume. You can also use this dialog to turn on or off individual sounds, such as tapping the screen.

TSC2 controller:

On the controller there are two places to control sounds.

Tap the speaker icon on the start bar and then use the slider to increase or decrease the volume. Tap [Off] to mute.

To modify other sound events such as program notifications and screen taps:

1. Tap [Start / Settings / Sounds & Notifications].
2. Configure the various sound controls as appropriate.

Using Bluetooth technology to print from a Trimble TSC2 controller

You can use Bluetooth wireless technology to establish a connection between a TSC2 controller and a Bluetooth-enabled printer and then print directly from the controller.

Note - Trimble CU controllers do not support printing using Bluetooth wireless technology.

Trimble has successfully printed using third-party printing software from Field Software Products and a Canon PIXMA iP90 BubbleJet printer, but other products may also be used.

To do this, you must:

- [Install third-party printing software](#)
- [Configure the controller to connect to a Bluetooth-enabled wireless printer](#)
- [Use the operating system on the TSC2 controller to print a document](#)

Installing third-party printing software

To print from the TSC2 controller, you must download and install printing software that is compatible with your Bluetooth-enabled printer.

To download and install the Field Software Products software:

1. Use ActiveSync technology to establish a connection between the TSC2 controller and an office computer.
2. Run Internet Explorer, and browse to www.fieldsoftware.com/PIEprint.htm.
3. Click on the link for the [PIEprint Installer for Pocket PC], and then select [Run].

The print software is automatically installed on the controller.

Note - For a list of supported printers, see www.fieldsoftware.com/PrintersSupported.htm.

Configure the controller to connect to a Bluetooth-enabled wireless printer

1. Turn on the printer.
2. If required, put the printer into discoverable mode. Do one of the following, according to your printer model:
 - ◆ Pentax PocketJet: with the printer switched on, press and hold the power key for 2 seconds.
 - ◆ Canon iP90: not required.
3. On the TSC2 controller, tap [Start / Settings / Connections].
4. Select the Bluetooth icon and then select [Turn on Bluetooth].
5. Tap the [Devices] tab.
6. If your printer is already listed, you are ready to print.
If you do not see your printer listed:
 1. Tap [New Partnership] to scan for Bluetooth devices.
 2. When the scan is complete, select your printer and then tap [Next].
 3. You do not need to enter a passkey. Tap [Next] to continue.
 4. From the [Partnership settings] screen, select [Serial Port] as the service to use from this device and then tap [Finish].
 5. Tap the [COM Ports] tab.
 6. Tap [New Outgoing Port], select your printer and then tap [Next].
 7. Select a COM port, clear the [Secure Connection] option and then tap [Finish].

The controller is now configured and ready to connect to the printer.

To print an HTML page

1. On the TSC2 controller open Internet Explorer.
2. Go to the HTML page that you want to print.
3. Tap and hold on an area of the HTML page that is not an image or a link. From the pop-up menu select [Print]. If [Print] does not appear on the menu, try tapping and holding in another empty part of the HTML page.
4. Set the [Print Sizing], [Print Range] and [Number of Copies] to be printed. You can also select to print the header and footer and reduce the text size.
5. Tap [Continue].

Tip - If you have previously selected your printer and other options, tap [Quick Print] to use the current printer and paper selections.

6. Select the [Printer] and set the [Port] to the same COM port as configured above. You can also select the color settings, paper size (including custom paper sizes), and orientation.

Note - Tap on [More Settings] to change other printer settings such as the margins and form feed settings.

7. Tap [Start Printing].

Tip - You may need to Exit the Trimble Survey Controller software if you are having trouble establishing a connection with the printer.

Power Indicators

The remaining battery power is displayed as a battery symbol in the status bar.

The symbol on the top represents the power remaining in the Trimble controller battery, or when using a Trimble CU the power remaining in the Trimble Robotic or GPS holder battery.

The symbol below the top battery symbol represents the remaining power in an external power supply, such as from a GPS receiver or conventional instrument. (This symbol only appears when an external power supply is connected.)

The level of shading in the symbol reduces as the power reduces.

Trimble CU Suspend Mode

The Trimble CU takes its power from an external power source, such as an instrument, Robotic Holder, GPS Holder, or a docking station.

The Trimble CU controller has an internal battery used while in suspend mode. Suspend mode enables you to remove the controller from one power source and then attach it to another power source within a time period that you define. You can then resume working from the same place in the software that you were before you

turned off the controller.

After the suspend time has elapsed, the battery automatically shuts down and the Trimble CU has to reboot when starting again. If the internal battery runs low on power the Trimble CU powers down sooner. Fully charged and under normal conditions, the internal battery should have capacity for five suspend sequences.

Note - Before you remove the Trimble CU from its power source, press the power button to turn off the controller. Otherwise the controller has to reboot when it restarts.

To configure the power settings on the Trimble CU:

1. Tap the [Start] menu and then select [Settings / Control Panel / Power].
2. Use the [Schemes] tab to configure the suspend state when connected using external power and battery power.
3. Use the [Systems Power] tab to display the current power status.
4. Use the [Power Key] tab to configure how the system behaves when the power key is pressed.

Attaching and Detaching Trimble CU Controller

Attaching the Trimble CU to the Trimble VX/S Series instrument, the controller holder, or the docking station.

- Place the top of the Trimble CU onto the hot shoe connector and then gently push the bottom of the CU downward until it clips firmly into place.

Detaching the Trimble CU from the Trimble VX/S Series instrument, the controller holder, or the docking station.

1. Switch off the Trimble CU. This suspends the controller, and prevents it from rebooting next time you apply power.
2. Push in the clip at the bottom of the CU and then gently pull the bottom of the CU outward until the controller is released.

Registration

Please remember to register your Trimble Survey Controller software by selecting the Register Software option on the CD. Registration gives you access to:

- News about software updates and specials
- New product information

Registration gives Trimble information that is used to develop the product and improve customer support.

Legal Notices

(c) 1992-2008, Trimble Navigation Limited. All rights reserved.

Trimble, the Globe and Triangle logo, Autolock, Geodimeter, GPS Total Station, Tracklight, and TSC2 are trademarks of Trimble Navigation Limited, registered in the United States Patent and Trademark Office and other countries.

FastStatic, RoadLink, Trimble Geomatics Office, Trimble Business Center, Trimble Link, Trimble Survey Controller, Trimble Total Control, TRIMMARK, and Zephyr are trademarks of Trimble Navigation Limited.

The Bluetooth word mark and logos are owned by the Bluetooth SIG, Inc. and any use of such marks by Trimble Navigation Limited is under license.

Microsoft, Windows, and ActiveSync are either registered trademarks or trademarks of Microsoft Corporation in the United States and/or other countries.

All other trademarks are the property of their respective owners.

This software is based in part on the work of the Independent JPEG Group, and derived from the RSA Data Security, Inc. MD5 Message-Digest Algorithm.

The Trimble Survey Controller software is covered by the following U.S. patents: 6985104, 6035254, 6021376, 6016118, 5969708, 5986604, 5831573, 5614913 and other patents pending.

About

To access the *About* dialog, tap *Configuration / About Trimble Survey Controller*.

The dialog contains the program version number, serial number, authorization key, software warranty expiry date, copyright, and patent information for the Trimble Survey Controller software.

Tap *Upgrade* to install a new option key for upgrading the software options.

Tap *Options* to see the options enabled on the controller.

For more information, see [Software options](#).

Troubleshooting

The message "Connection failed" appears when you try to connect to a Bluetooth cellular modem. Some cellular modems have different Bluetooth modes. If the mode is set to [Off] or [Automatic], a "Connection failed" message may appear. For a successful Bluetooth connection, set the mode to [On].

The message “Hardware Error –1” appears when you tap [Scan] in the [Bluetooth Device Properties] applet.

Clear, then re-select the [Enable Bluetooth] check box.

Bluetooth controller does not always find all the Bluetooth devices within the specified range

A Bluetooth scan cannot always find other Bluetooth devices during the scan if there is another Bluetooth device scanning in the same area. If the device you are looking for is not found during a scan, wait a minute, and then scan again.

Bluetooth device not registered

If this message appears when you start an internet RTK survey, you have selected *Internet connection* as your rover radio when you are using a Trimble Internal GPRS module. You must select *Trimble Internal* as your rover radio and set the method to *GPRS internet*.

Bluetooth scan finds a [(null)] device

Sometimes during a Bluetooth scan, a Bluetooth device within range is found, but not the device name. In this case, a [(null)] name is returned. Re-scan for the device until the correct name is returned.

Bluetooth operating range difficulties

Bluetooth has an operating range of 10 meters (~33 feet).

Bluetooth [Scan] cannot find the Trimble 5800 receiver

If the Bluetooth connection between the 5800 receiver and a Trimble CU has been disrupted, or if the receiver is already connected to another Bluetooth device, [Scan] may fail to find the receiver.

Switch off the receiver, then switch it on again. Enable the [Enable Bluetooth] check box if it has been cleared and do another scan. If the [Scan] still cannot find the receiver, perform a warm boot on the receiver. Do another scan.

Intermittent communication errors when using Bluetooth

Make sure that your body does not block the line-of-sight between the two devices that are communicating with Bluetooth.

Initialization lost because of high RMS

The receiver has discarded the current initialization because the measurement RMS has stayed too long above an internal cut-off value. This may be caused by too much pole movement when static, by a very bad environment, or by incorrect initialization. Check two or three points measured with the initialization that was lost. To do this, reinitialize in a good environment and remeasure the points. If the remeasurements agree within RTK tolerances, you can be confident that the initialization was correct and that a bad environment caused the loss of initialization.

"Cannot start streamed corrections" message in internet survey

Make sure that the Internet connection you are using works outside of Trimble Survey Controller. Connect to the Internet, browse one or two websites, and use Google.com or similar. Leave that connection open and start a survey with Trimble Survey Controller. If the survey still fails to start correctly, there may be a problem with the IP addresses or port numbers in the style, or the base station providing the data may not be operational.

Conventional instrument behaving erratically

Set the *HA VA status rate* to Never if the instrument screen blinks erratically or has problems maintaining communication with the Trimble Survey Controller software. Some instruments cannot support a high status update rate.

Conventional instrument will not connect

Always select the correct survey style in the Trimble Survey Controller software before connecting the controller to a conventional instrument. Otherwise, they may fail to connect. If this occurs, reset the conventional instrument by switching it off and then on, and then try to connect again.

Modem is not responding

This message may appear after a *Connecting to modem* dialog has to be cancelled because it goes on indefinitely. If this happens, power cycle the modem.

If you see the "Modem is not responding" message when connecting to an Enfora GSM/GPRS card, you may need to set the baud rate. To do this:

1. On the controller, tap [Start / Settings / Connections].
2. Tap the [Connections] icon and then select [Manage existing connections] under [My ISP].
3. Select the connection name for the Enfora card that you created earlier, and tap [Edit].
4. Tap [Next] twice and then tap [Advanced].
5. Set the [Baud rate] to 115200.
6. Tap [Ok] and [Finish] as required to exit the Enfora configuration.

"No Base Data" when Internet Surveying

If you start an internet RTK survey and the *No base data* message appears, check the broadcast format, the initialization string for your modem, the IP address, and the port number of the base.

"No Carrier" message when dialling up an RTK base

This message means that the base is not answering, or that the rover cannot get a dial tone. Call the base manually to make sure that it answers, and is not going to a voicemail system. Check that the rover has enough money on its account.

No communication between instrument and the Trimble Survey Controller software

Check the cables, connections and switches. Also check the power source to the receiver or conventional instrument.

Note - Make sure that you have selected an appropriate survey style.

No coordinates in Review

Check the *Coordinate view* setting. Tap *Options* to change the coordinate view.

To see grid coordinates in review, this setting must be grid. Also, to display grid coordinates, a projection and datum transformation must be defined.

In conventional surveys, check that the instrument and/or backsight point has been coordinated.

In conventional surveys, an observation is displayed with null coordinates until the observation to the backsight is stored.

No data recorded in receiver

Check the Base and Rover options in the survey style. Is the logging device set to Receiver? Is the antenna connected? Is power connected?

No grid coordinates

Check that a projection and datum transformation have been defined. Also check that the *Coordinate view* setting is Grid. To do this, select *Files / Properties of current job / Units*.

Not receiving radio

Check that all radio cables are connected to the correct ports and that the radio is switched on.

Check that the radios are configured correctly in the Survey Style.

Check that there are no obstructions (for example, trees or buildings). If there are, move to a place where the radio signals will not be obstructed.

Check that the base radio is switched on.

Radio connection difficulties between the TSC2 and the Trimble VX/S Series instrument

Make sure that the radio settings on the TSC2 controller are set correctly. The *Radio channel* and *Network ID* can be configured on the instrument and in the Trimble Survey Controller software. If you are using a TSC2 controller, check the [Port Settings] to ensure that they are correctly configured:

1. Tap the Trimble icon on the Pocket PC Start bar.
2. Tap [Trimble Radio Settings].
3. Configure the [Radio channel] and [Network ID] to the same values as those set on the instrument.

Note - The radio channel and network ID can also be set using the Trimble Survey Controller software.

4. In the [Port Settings] field, select one of the following:
 - ◆ [Internal], if you are using a built-in radio.
 - ◆ [External], if you are using an external radio.
5. Tap [ok].

Receiver does not turn on

Check the cables, connections, and switches. Also check the power source.

RTK survey will not work

Check that you have selected an RTK Survey Style. Check that it is configured for RTK in the *Type* field in both the Base and Rover options. Check that the antenna is configured correctly in the *Antenna Type* field in Base and Rover options. Check that the radio is working and that it has been configured correctly.

RTK precisions are too high

Is RTK mode Fixed? If it is not, initialize the survey.

If the mode is Fixed, remain stationary on the point for a while and wait for the precisions to decrease. If you are in stakeout, tap *Fine* to go into fine mode.

Satellite/s not being tracked

Check that there are no obstructions - look at the azimuth and elevation of the SV in the *GPS / Satellites* screen. Check the GPS antenna connections. Check the elevation mask setting. Check that the satellite is not disabled - tap *Info* in the *Satellites* screen. Are there any transmitting antennas nearby? If there are, reposition the GPS antenna.

Job Repair Wizard

The Job repair wizard runs when Trimble Survey Controller detects damage in the job file. You can cancel the wizard at any point or go back to any previous step.

The wizard retrieves job data up to the point of the damage, discards anything beyond this point, and informs you of the time and date of the last good item in the job.

As a safety measure, the wizard can make a copy of the job before anything is discarded. Before proceeding with the copy, check that the file system has enough space for a copy of the entire job.

Once the repair is completed, use *Files / Review current job* to check what (if anything) has been discarded from the end of the job. Because the job is stored in chronological order, anything discarded is timed later than the last good record reported by the wizard.

Be aware that discarded data may include changes made to the job such as deletions (the item may no longer be deleted), changes to antenna or target heights, coordinate systems, and new items such as points, observations, and lines.

Damage to Job files may be caused by a hardware problem, a failure to properly shut down the Trimble Survey Controller program, or an unexpected power failure due to a flat battery. When the Job wizard reports a problem, review the controller's operating procedure, and/or check the hardware. If you repeatedly experience corruption problems, there may be a fault in your controller hardware. For more information, contact your local Trimble dealer.

Job Operations

Job

A job can contain several different surveys. Select a job before you measure any points or make any calculations.

Jobs can be saved in the [Trimble data] folder, or in the [project folders](#) below [Trimble data].

To create a new job:

1. From the main menu, select *Files / New job*.
2. Enter a name for the new job.
3. Tap  to create a new folder or select an existing folder.
4. Tap the *Coord. sys.* button and choose a [coordinate system](#) for the job. Tap *Next*.
5. Configure the coordinate system settings required for the job and tap *Store*.
6. Tap the *Units* button to specify the units and various other settings for the job. Tap *Accept*.
7. Tap the *Linked files* button to select a linked file(s) for the job. Tap *Accept*.
8. Tap the *Active map* button to select an active map file(s) for the job. Tap *Accept*.
9. Tap the *Feature library* button to associate a feature library with the job. Tap *Accept*.
10. Tap the *Cogo settings* button to set the cogo settings for the job. Tap *Accept*.
11. Optionally, tap the *Page down* button to enter *Reference*, *Description* and *Operator* details, and any *Notes*.
12. Tap *Accept* to save the job.

To open a job:

1. From the main menu, select *Files / Open job*.
2. Tap  to expand a folder and display the files within the folder.
3. Tap the job name, or highlight the job name and tap *OK*.
The job name appears in the title area of the main menu.

To delete a job:

1. From the main menu, select *Files / Open job*.
2. Tap  to expand a folder and display the files within the folder.



If the job you want to delete is not highlighted, use the arrow keys to highlight it, or tap and hold it with the stylus.

Note - If you tap with the stylus without holding, the job that you highlight opens automatically.

3. Tap  to delete the file.
4. Tap *Yes* to confirm deletion, or *No* to cancel.

Note - When you delete a job, associated files (for example, *.t01, *.tsf *.jpg) are not automatically deleted.

To copy a job:

1. From the main menu, select *Files / Open job*.
2. Highlight the name of the job to be copied and tap  .
3. Browse and highlight the folder to paste the file into and tap  .

Tip - You can also use *Windows/File Explorer* to copy, rename, or delete a file.

Note - When you copy a job to another folder, associated files (for example, *.t01, *.tsf *.jpg) are not automatically copied.

To create a new job with all the defaults (including Coordinate System settings) from another job:

1. From the main menu, select *Files / Open job*.
2. Tap  to select the folder, if required.
3. Select and open the job that contains the settings to use as the defaults for the new job.

Note - To use the settings in the **current** job as defaults for the new job, omit steps 1 and 2. New jobs always use the settings from the previous job as defaults.

4. From the main menu, select *Files / New job*.
5. Enter a name for the new job.
6. Tap the appropriate button to change job settings as required.
7. To save the job, tap *Accept*.

File management and Project folders

The Trimble Survey Controller software version 12.10 and earlier saved all Trimble Survey Controller files in the [Trimble data] folder. The Trimble Survey Controller software version 12.20 and later can still be used with all files in the [Trimble data] folder, but you can also create individual 'project folders' to help manage your jobs and the associated files.

The [Trimble data] folder is treated as the system folder and contains all the 'system' type files. If you do not use project folders, the [Trimble data] folder will also contain all your project files, and in this case can also be referred to as the project folder.

When you create files using *Export fixed format files* or *Export custom format files*, you can save the new format files to an existing folder on the controller, or create a new one. The default folder is the [Export] folder below the current [project folder](#). If you change the project folder, the system creates an export folder under the new project folder, and gives it the same name as the previous export folder.

Tap  to select an existing folder or create a new one.

The following table shows the file extension on the office computer, the file extension on the controller (which changes if the file is converted during transfer), the file description, and the location the file is saved to if you use project folders.

Computer file extension	Controller file extension	Description	Resides in [Trimble data]	Resides in Project folder
.dc	.job	Trimble Survey Controller job files	-	*
.csv	.csv	Comma Delimited (CSV) files	-	* 1
.txt	.txt	Comma Delimited (TXT) files	-	* 1
.dtx	.dtm	Digital Terrain Model files	-	*
.ttm	.ttm	Triangulated Terrain Model files	-	*
.fcl	.fal	Feature and Attribute Library files (TGO)	*	-
.fxl	.fxl	Feature and Attribute Library files (TBC)	*	-
.ddf	.fal	Data Dictionary files	*	-
.ggf	.ggf	Geoid Grid files	*	-
.cdg	.cdg	Combined Datum Grid files	*	-
.pjpg	.pjpg	Projection grid files	*	-
.sgf	.sgf	Shift grid files	*	-
.pgf	.pgf	UK National Grid files	*	-
.dxf	.dxf	Map files	-	* 1
.shp	.shp	ESRI map shape files	-	*
.ini	.dat	Antenna files	*	-
.lng	.lng	Language files	- 2	- 2
.wav	.wav	Sound files	- 2	- 2
.dat	.dat	GPS data files	-	*
.t01 .dat	.t01	GPS data files	-	*
.crd .inp .mos	.crd .inp .mos	GENIO road files	-	*
.xml	.xml	LandXML road files or XML Documents	-	*
.jxl	.jxl	JobXML files	-	* 1
.ixl	.ixl	Custom ASCII Import file definitions	*	-
.xsl	.xsl	XSLT Custom ASCII Export Stylesheet files	* 3	-
.sss	.sss	XLST Custom Stakeout Stylesheet files	* 3	-
.mcd	.mcd	Measure Codes Database files	*	-
.dc	.rxl	Trimble road file	-	*
.rxl	.rxl	Alignment files	-	*
.txl	.txl	Tunnel file	-	*
.csd .csw	.csd	Coordinate System Database files	*	-
.jpg	.jpg	Image files	-	*
.tsf	.tsf	Scan files	-	*

Notes

1. .csv, .txt and JobXML files that are transferred to the controller should be transferred to the Project folder.
Files that are exported on the controller are stored in the Export folder below the project folder. To link an exported .csv file, copy the file into the project folder using Explorer.
2. Language files (.lng) and Sound files (.wav) are stored in the appropriate language folder.
3. Stakeout stylesheet files (.sss) and Custom Export stylesheet files (.xsl) can be located in both the language folder or [Trimble data]. Translated Stakeout stylesheet files and translated Custom Export stylesheet files are typically stored in the appropriate language folder.

Notes on transferring files to and from folders on the controller:

- When you transfer files to or from the controller with Trimble Geomatics Office, you can select existing project folders on the controller.
- When you transfer files to or from the controller with Trimble Business Center, you can only transfer files to and from the [Trimble data] folder.
- When you transfer files to the controller with Trimble Data Transfer utility, you can only transfer files to the [Trimble data] folder on the controller.
- When you receive files from the controller with Trimble Data Transfer utility, you can receive files from the [Trimble data] folder or existing project folders on the controller.
- To create new project folders or move files from one folder to another, use the Trimble Survey Controller software or Windows Explorer.

Properties of Current Job

Use this menu to configure settings for the current job.

For more information, see:

[Coordinate system](#)

[Units](#)

[Linked files](#)

[Active map files](#)

[Feature library](#)

[Cogo settings](#)

[Descriptions](#)

Each button displays the current settings. When you create a new job, settings from the previous job are used as the defaults. Tap a button to change the settings.

Tap *Accept* to save any changes.

Review Current Job

To see the records stored in the job database:

1. From the main menu, select *Files / Review current job*.
2. Use the arrow keys, stylus, or softkeys to navigate the database.

Tip - To move to the end of the database quickly, highlight the first record and press the up arrow key.

Tip - To highlight a field without selecting it, tap and hold briefly with the stylus.

3. To see more information about an item, tap the record. Certain fields, for example, *Code* and *Antenna height*, can be edited.

Note - Offset points that are stored as coordinates are not updated when you change an antenna or target height record in the database. In addition, a change in antenna height does not affect any postprocessed points that will be processed using the Trimble Geomatics Office software. Verify the antenna or target height information when you transfer the data to the office computer or transfer postprocessed points directly from the receiver to the office software. When you change an antenna or target height record in the database, stakeout deltas, Cogo points, averaged points, calibrations, resections, and traverse results are not automatically updated. Re-observe staked out points, and re-calculate Cogo points, averaged points, calibrations, resections, and traverses.

To search for a particular item, tap *Search* and select an option.

Tip - To review features from the *Map of current job* screen, select the required feature(s), tap and hold on the screen and choose *Review* from the shortcut menu.

Inserting notes

To store a note in the database:

1. Highlight a record.

Tip - To highlight a field without selecting it, tap and hold briefly with the stylus.

2. Tap *Note*. The *Note* screen that appears displays the date and time that the current record was created.
3. Enter the note and then tap *Accept*. The note is stored with the current record. In *Review current job*, the note appears below the record with the note icon.

Editing target/antenna records using Review current job

Select *Review current job* to edit existing antenna or target height records. These edits change the antenna or target height for all observations using that antenna or target height.

To edit a target/antenna record:

1. Tap the target/antenna record. The current target (conventional survey) or antenna (GPS survey) details appear.
2. Enter the new details and then tap *Accept*.

The current record is updated with the new details, which apply to all subsequent observations using that record.

A note with a timestamp is attached to the record. This note documents the old details, including when the changes were made.

Editing target/antenna records using Point manager

Use [Point manager](#) to easily change the target or antenna height of a single observation or any number of observations.

Editing codes using Review current job

If you have only a single code to edit, you can use *Review current job*.

To edit a code:

1. From the main menu, select *Files / Review current job*.
2. Tap the observation record that contains the code you want to edit.
3. Change the code and then tap *Accept* to store the changes.

The Note stored with the observation is a record of the old code and the date and time it was modified.

Editing codes using Point Manager

You can use *Point manager* to edit single or multiple codes.

When you edit multiple codes, the *Point manager* is easier to use than *Review current job*.

For more information, see [Point manager](#).

Editing point names and point coordinates using Point Manager

You can use *Point manager* to edit point names or point coordinates.

You cannot edit point names and point coordinates using *Review current job*.

Deleted points, lines, and arcs

A deleted point, line, or arc is not used in calculations, but it is still in the database. Deleting points, lines, or arcs does not make a job file smaller.



When you transfer a file that contains deleted points, the deleted points are not transferred to the office software. If you transfer a file using the Trimble Data Transfer utility, however, the deleted points are

recorded in the Data Collector (.dc) file. They have a classification of Deleted.

Some points, such as continuous offset points and some intersection and offset points, are stored as vectors from a source point. If you delete a source point, any point stored as a vector from that point has null (?) coordinates when you review the database point record.

To delete a point, line, or arc in the Trimble Survey Controller database:

1. From the main menu, select *Files / Review current job*.
2. Highlight the point, line, or arc to be deleted and tap *Details*.
3. Tap *Delete*. For points, the search class changes to Deleted (normal), Deleted (control), Deleted (staked), Deleted (backsight), or Deleted (check), depending on the original search classification.
4. Tap *Accept*. The Trimble Survey Controller software records a note with the original point, line, or arc record, showing the time it was deleted.

When you delete a point, line, or arc, the point symbol changes. For example, for a topo point, the  symbol replaces the  symbol.

When you delete an observation that has been recorded during a [Station setup plus](#), a [Resection](#), or [Measure rounds](#) operation, the mean turned angle records and station or round residuals records will not be updated. Deleting an observation that has been used to compute an average does not automatically update the average. Use *COGO / Compute average* to recompute the average.

Tip - To delete features from the *Map of current job* screen, select the required feature(s), tap and hold on the screen and choose *Delete* from the shortcut menu. Select the feature(s) to delete and then tap *Enter*. You cannot delete points from a linked file.

Use Explorer to delete alignment files, road files, map files, or any other file type stored on the controller.

Note - You cannot delete points, lines or arcs from a linked map file (for example, a DXF or SHP file).

To restore a point, line, or arc in the Trimble Survey Controller database:

1. From the main menu select *Files / Review current job*.
2. Tap the point, line, or arc record to be restored.
3. Tap *Undelete*.
4. Tap *Accept*.

Point Manager

As an alternative to *Review current job*, use the *Point manager* to manage your data.

You can easily review:

- Point coordinates
- Observations

- The [best point](#) and all duplicate points
- Target and antenna heights
- Codes and notes
- Descriptions
- Notes

You can easily edit:

- Target and antenna heights (single or [multiple](#))
- [Point names](#)
- [Point coordinates](#)
- Codes (single or [multiple](#))
- Descriptions (single or multiple)
- Notes

Using Point manager

To open *Point manager*, select *Files / Point manager* from the main menu. The screen that appears shows a tabulated tree structure of all points and observations in the job database and linked files.

Viewing the data

When there are duplicate points of the same name, the best point always appears first. All occurrences of points of the same name, including the best point, appear in a list below the best point.

However, when the data is in the *Target height* view, all observations in the database appear in the order that they occur in the database.

To change the view of the data, select *Display*. For example, to view coordinates, set *Display* to Grid; to view or edit target heights, set *Display* to Target height.

Note - In *Point manager*, the *Target height* setting refers to both antenna height and target height.

To sort the data, tap the column heading.

To change the width of the column, or to hide the column, tap and drag the separator between headings.

Use the scroll bars to scroll horizontally or vertically through the data.

Tip - To freeze the Point name column, tap and hold the Point name column heading. To unfreeze the column, tap and hold the heading again.

To filter the displayed point information, tap *Filter*. Select the column to filter point information from and then enter the filter details. The points are filtered so that only those in the selected column, and that contain the filter details, appear.

Note - To see a complete list of the icons and their descriptions used in the Trimble Survey Controller software see the [filter table](#).

Tip - If there are too many matches, enter a more restrictive filter string or use the *Match whole word only* check box to narrow the search parameters.

To disable the filter, clear the *Filter* field.

To view more information on a point do one of the following:

- To reveal all associated points and observations, tap + to expand the point tree list. Expand the subtree to view individual point information. These records can include the point coordinates, observations, antenna or target details, and quality control records.
- To open the same point form as seen in *Review current job*, tap a point, or highlight a point and tap *Details*. This allows you to edit information such as the point code and attributes.

To change the format of the indented coordinates or the observations that appear when you expand the point tree, tap the coordinates or observations displayed, or highlight them and press the space key. In the list that appears, select the new data view.

This allows you to review the raw conventional observations (or WGS-84 observations) and the Grid coordinates at the same time.

Reviewing and editing antenna and target heights

Note - In *Point manager*, the *Target height* setting refers to conventional target heights and the GPS antenna heights.

To change a target height record and update **all** observations using that target height record, edit the target height in [Review current job](#).

To change an individual target height, or group of target heights, in *Point manager*:

1. From the main menu, select *Files / Point manager*.
2. Tap *Display* and then select *Target height*. In the screen that appears, the point name, from point, target height, code, and note are listed in the order they exist in the database.

- To change the record order, tap the appropriate column heading.
- To filter the list, tap *Filter*, select the appropriate column and then enter the filter details.

Tip - If you enter a filter value of 2 for a point name, the system will show all points with 2 in their name, including 2, 1002, 2099, or 2day. To filter for a point name "2", select the Match whole word check box.

3. To select a target or multiple targets for editing, do one of the following:

- Tap the *Target* field.
- Use the arrow keys to highlight the record to edit and then tap *Edit*.
- To select multiple fields, press and hold *Ctrl* and then tap the required fields. Then tap *Edit*.
- To select a range of fields, tap the first required field, press and hold *Shift* and then tap the last required field. Then tap *Edit*.

4. In the *Target details* form enter the new *Target height* and/or *Prism constant*. To store the changes, tap *OK*.

When measuring to the bottom notch on a [Trimble prism base](#), tap the advanced pop-up arrow () and then select *Bottom notch*.

Point manager now displays the corrected target details. In *Review current job*, view the inserted target records with notes that record the old target details.

Group editing Target heights (conventional) and Antenna heights (GPS)

You can use the *Point manager* to edit details of antenna heights or target heights for multiple-selected points. This function is available when the *Display* softkey setting in the *Point manager* is set to *Target height*. Use the standard Windows selection methods of *Ctrl-click* and *Shift-click* to choose the points to apply the target or antenna height edits to.

- When you edit antenna heights, you can edit the measured heights and the measurement method.
- When you edit target heights, you can edit the measured target height value, the measurement method (when applicable), and the prism constant.
- When you select points to edit, you can include points with target heights and points with antenna heights. When you tap *Edit*, two dialogs appear - one to edit antenna heights and one to edit target heights.
- You do not need to select contiguous target and/or antenna heights to edit.
- You cannot edit a selection of antenna heights that includes more than one type of antenna. In this case, select and edit the points in separate groups, according to the type of antenna used.
- You can edit a selection of different targets. In such a case, the new target heights are applied to each of the different targets but the target numbers remain unchanged.
- Some conventional measurements use calculated (system) targets, which have a zero height and zero prism constants, for example, Dual-prism offset. You cannot edit the target heights for system targets.
- You can sort *Point manager* columns to help you find and select groups of target or antenna heights to edit. Tap the column heading to sort that column.
- The *Point manager* automatically inserts the appropriate target and antenna equipment records into the job database to ensure that the correct heights and measurement methods are assigned to each point.
- When you edit points, the *Point manager* automatically inserts notes into the job database to record what was edited, the original measurement data, and the time of the edit.

Editing Point Coordinates using Point manager

You can use the *Point manager* to edit the coordinates of imported or keyed in points.

To edit the coordinates of a point:

1. From the main menu, select *Files / Point manager*.
2. To select the record to edit, tap and hold the stylus on the record.
3. Tap *Edit* and then select *Coordinates*.
4. Edit the coordinates and then tap *OK* to save the changes.

You cannot edit the coordinates of:

- raw observations
- points in linked files
- a range of records at one time

A record of the changes made are saved to the *Note* record.

Renaming point names using Point manager

You can use the *Point manager* to edit the names of points and observations.

To rename a point or observation:

1. From the main menu, select *Files / Point manager*.
2. To select the record to edit, tap and hold the stylus on the record.
3. Tap *Edit* and then select *Point names*.
4. Edit the name and then tap *OK* to save the changes.

You cannot edit the name of

- points in linked files
- an observation to the current station if a survey is running
- a backsight observation

A record of the changes made are saved to the *Note* record.

Editing point names and point coordinates in a dynamic database

The Trimble Survey Controller software uses a dynamic database. If you change the name or coordinates of a record, the positions of other records that rely on that record could change or disappear.

The rest of this section describes how changes to a base station position, station setup, or backsight position can affect other positions. In addition to these record types, changes to resections, lines, arcs, compute inverse records, and others may also affect other positions. For more details on specific records that may change, see the table below.

If you rename a point name that is used as a base in a GPS survey, or as a station setup point in a conventional survey, this does not rename the point name that is referenced in the Base record or Station setup record. You cannot edit the point name referenced in the Base record or Station setup record in any way.

If you rename the base position or station setup position, and another record with the same name **does not** exist, then the positions of all records that are computed from that base position or station setup position cannot be computed, and those records will no longer be displayed in the map.

If you rename the base position or station setup position, and another record with the same name **does** exist, then the positions of all records that are computed from that base position or station setup position may change, as they will now be computed from the next best point with the same name.

If you edit the base position or station setup position, then the positions of all records that are computed from that base position or station setup position will change.

If you edit the azimuth in an a station setup with a keyed-in azimuth to the backsight, then the positions of all records that are computed from that station setup will change.

If you edit or rename the point record that is used as a backsight in a station setup with a computed azimuth to the backsight, then the positions of all records that are computed from that station setup may change.

If you select a range of records and change their name, all the selected records are renamed to the new name that you entered.

If you rename or edit the coordinates of points, all records that contain computed deltas to other points, for example as-staked, check, and backsight observations, are not updated.

In the following table, the * symbol against a record type shows the dynamic database records that may change if the name or the coordinates of the record that was used to derive their position is modified.

Record	Names	Coordinates
Topo points (GPS)	*	*
Rapid points	*	*
FastStatic points	*	*
Observed control points	*	*
F1 Topo points (Conv.)	*	*
F2 Topo points (Conv.)	*	*
Mean turned angle	*	*
As-staked points	*	*
Check points	*	*
Continuous points	*	*
Construction points	*	*
Laser points	*	*
Lines	*	*
Arcs	*	*
Compute inverse	*	*
Resection points	-	-
Adjusted points	-	-
Averaged points	-	-
Cogo points (computed) (see note below)	* 1	* 1
Intersection points	-	-
Offset points	-	-
Roads	-	-
Alignments	-	-

Tunnels	-	-
Calibration points	-	-
Compute area	-	-

1 - Cogo points can change if the point they are computed from is modified, but it depends on how the Cogo points were stored. If they were stored as a vector, for example Az HD VD and the base point is moved, then the Cogo point will also move.

Adding or editing codes using Point manager

To enter a code or change an existing code, tap the *Code* field. Enter the code details, and the attributes, if required. Tap *Accept* to store the changes.

Group editing codes using Point Manager

You can use the *Point manager* to edit code details for more than one point at a time.

1. Use the standard Windows selection methods; press **Ctrl** or **Shift** and tap the records for which you want to change the code.
2. Tap *Edit* and then select *Codes*.
3. Enter the new code and then tap *Enter*.

If the code has attributes, you are prompted to enter them.

The new codes are updated and displayed in the *Point manager*. A note with the old code value is stored for each modified record.

Tip - You can edit Descriptions in the same way.

Adding or editing notes using Point manager

To enter a note or change an existing note, tap the *Note* field. Enter the note details and then tap *Accept* to store the changes.

QC Graph

The *QC Graph* screen displays a graph of quality indicators that are available from data in a job. To change the type of data to display, tap *Display*. To scroll along the graph, use the arrow buttons. To view basic details of a point, tap the graph. For more information, double tap the graph to access *Review*.

You can view a graph of:

- Horizontal precision
- Vertical precision
- Satellites
- PDOP

- RMS
- HA standard error
- VA standard error
- SD standard error
- Elevation
- Target height

Storing Points

How you record a point determines how it is stored in the Trimble Survey Controller software. Points are stored either as vectors or as positions. For example, RTK points and conventionally observed points are stored as vectors, while keyed-in points, real-time differential points, and postprocessed points are stored as positions.

To review details about a stored point, from the main menu, select *Files / Review current job*. A point record contains information about the point, such as the point name, the code, the method, the coordinates, and the GPS data file name. The *Method* field describes how the point was created.

The coordinates are expressed as WGS-84, local, or grid coordinates, depending on the setting in the *Coordinate view* field. To change a *Coordinate view* setting, do one of the following:

- Select *Files / Properties of current job / Units*.
- Select *Files / Review current job*. Access the point record and then tap *Options*.

Note - Define a datum transformation and/or a projection if you want to display local or grid coordinates for a GPS point. Alternatively, calibrate the job.

Each point record uses the antenna height given in the previous antenna height record. From this, the Trimble Survey Controller software generates a ground height (elevation) for the point.

The following table shows how the point is stored in the *Stored as* field.

Value	What the point is stored as
Grid	Grid coordinates
Local	Local geodetic coordinates
WGS-84	WGS-84 geodetic coordinates
ECEF	WGS-84 Earth-Centered-Earth Fixed X, Y, Z coordinates
ECEF deltas	WGS-84 Earth-Centered-Earth Fixed X, Y, Z vector
Polar	Azimuth, horizontal distance, and vertical distance. This is a vector.
HA VA SD	A horizontal circle reading, vertical circle reading (a zenith angle), and slope distance. This is a vector.
HA VA SD (raw)	A horizontal circle reading, vertical circle reading (a zenith angle), and slope distance with no corrections applied. This is a vector.
Mag.Az VA	A magnetic azimuth, vertical (zenith) angle, and slope distance vector.

SD	
MHA MVA MSD	A meaned horizontal angle from the backsight, meaned vertical angle (a zenith angle), and meaned slope distance. This is a vector.

Read the *Stored as* field in conjunction with the *Method* field.

For points calculated using *Cogo/Compute point*, you can choose how to store that point. The available options depend on the selected coordinate system and the type of observation used in computing the point.

Note - Points stored as vectors are updated if the calibration or coordinate system of the job changes, or the antenna height of one of the source points is changed. Points stored as WGS-84 coordinates (for example, an offset point calculated using the *From a baseline* method) are not updated.

For GPS points, Quality Control (QC) records are stored at the end of the point record.

Point Classification

When points are stored they have either one or two classifications:

- Points that have been measured using GPS have an observation class and a search class.
- Points that have been keyed in, computed, or measured with a conventional instrument or laser rangefinder have only a search class.

Observation class

For real-time surveys, the observation class is L1 Fixed, L1 Float, WA Fixed, WA Float, or L1 Code, and precisions are recorded. For postprocessed surveys, the observation class is autonomous and no precisions are recorded.

The following table lists the observation classes and resulting solutions.

Observation class	Result
L1 Fixed	An L1 fixed real-time kinematic solution.
L1 Float	An L1 float real-time kinematic solution.
L1 Code	An L1 code real-time differential solution.
Autonomous	A postprocessed solution.
WAAS	A position that has been differentially corrected using WAAS/EGNOS signals.
WA Fixed	A fixed solution using Wide Area processing.
WA Float	A float solution using Wide Area processing.

Search class

A search class is applied to a point when it is measured, keyed in, or computed. The search class is used by the Trimble Survey Controller software when details of a point are required for stakeout or calculations (for example, for Cogo calculations).

For more information, see [Database search rules](#).

Map of Current Job

The *Map of current job* screen is a graphical representation of features from multiple sources:

- points, lines, and arcs from the current job database
- points, lines, and arcs from linked jobs and linked CSV files
- points, lines, arcs, polylines, and other map entities from [map files](#) (for example DXF and SHP files)
- alignments defined as .rxl files and stored in the current project folder
- Trimble roads defined as .rxl files and stored in the current project folder
- digital terrain models stored in the current project folder

Use the following links to learn more about using the map:

- [Accessing the map](#)
- [Using the map softkeys and options](#)
 - ◆ [Zoom previous and zoom default](#)
 - ◆ [Widescreen mode](#)
 - ◆ [Point type filtering](#)
- [Selecting a feature in the map](#)
- [Deselecting a feature in the map](#)
- [Tap and hold shortcut menu](#)
 - ◆ [Current job](#)
 - ◆ [Linked file or Active map](#)
- [Autopan](#)
- [Linked files \(.csv .txt .job\)](#)
 - ◆ [Transferring linked files](#)
 - ◆ [Stakeout points from a linked file](#)
- [Active map](#)
 - ◆ [Layers and selectability](#)
 - ◆ [Colors in the map](#)
 - ◆ [Transferring and selecting maps](#)
 - ◆ [Notes on active maps, including supported map entity types](#)

To access the *Map of current job* screen:

1. Tap *Map*. The current position of the GPS antenna is displayed as a vertical/horizontal cross. The current orientation of a conventional instrument is shown by a dotted line extending from the instrument to the end of the screen. The location of the prism is shown as a cross when a distance is measured.
2. Use the [map softkeys](#) to navigate around the map.

Note - Only grid coordinates are displayed. If you have not defined a projection, only points stored as grid coordinates appear.

If there is a point with the same name as another point in the database, the point with the higher search class is displayed. For more information about how the Trimble Survey Controller software uses search classes, see [Database search rules](#).

Note - If the *Grid coords* field in the [Cogo settings](#) screen is set to Increase South-West or Increase South-East, this screen is rotated by 180°. The letter N on the north arrow denotes Grid 0°.

Map Softkeys

Use the map softkeys to:

- navigate around the map
- change the map display options

Some softkeys can operate in an "active" mode. The effect of tapping on the map depends on the active softkey selected.

The functions are described in the following table:

Softkey	Function
+	Tap this softkey to zoom in. Tap and hold the softkey to make it active. Tap the area of the map to zoom in on, or drag to create a box around the area of interest.
-	Tap this softkey to zoom out. Tap and hold the softkey to make it active. Tap the area of the map to zoom out from.
<i>Pan</i>	Tap this softkey to shift the center of the map area to another part of the map. Tap the softkey to make it active. Tap an area of the map to center on, or tap and drag the map area to where you want to pan.
	Tap this softkey to show all features on the screen. Tap the softkey to make it active.

Click the up arrow to access more softkey functions. The additional functions are described in the following table.

<i>Filter</i>	Shows a legend for the feature symbols and lets you choose which features are displayed.
<i>Pan to</i>	Displays the <i>Pan to point</i> screen. Enter a point name and scale value.
<i>Options</i>	Controls how name or code labels appear next to points in the map.
	Controls the options to display road and alignment stationing.
	Controls the options to display the points symbols and coded features for each point. If the <i>Display coded features</i> check box is selected, Trimble Survey Controller software draws lines between points that have feature codes with the <i>Feature type</i> configured to <i>Line</i> . When you create or edit a feature code, set the <i>Feature type</i> to <i>Line</i> and specify a <i>Line style</i> .
	Controls the option to display points from the stakeout list in the map. To do this, set the <i>Display stakeout list points</i> field to <i>Yes</i> .

	Controls the Automatic pan to your current position option.
	Tap the automeasure option to automatically start a measurement when you press the measure key.
	Controls the option to display elevations in the map.
	Controls the option to display the map in Widescreen mode .
Layers	Controls the display of one or more active map files or layers.
	Controls the selectability of one or more active map files or layers.
	Controls the display and selectability of alignment files.
	Controls the display and selectability of Trimble road files.
	Controls the display and stake-ability of digital terrain models.

To explode polylines into individual line and arc segments, enable the *Explode polylines* check box in *Map / Layers / Options*.

Zoom previous and Zoom default

In the map view, tap and hold the map softkey to display more navigation options:

- Zoom to the previous view
- Zoom to a default scale and location
- Set a default scale and location

Widescreen mode

The map appears in widescreen mode across the entire width of the screen.

To access the status bar while the map is in widescreen mode, tap the mini status bar icon in the upper right corner of the map. The status bar appears for approximately three seconds, after which time the map returns to widescreen.

To change the widescreen mode, do one of the following:

- Tap and hold in the map window and then select *Widescreen*
- Tap *Options* within the map screen and then select the *Widescreen* setting
- Press the '.' key on the controller

Filter

Use the *Filter* softkey to control:

- features to display. For example, tap *Map / Filter*.
- points to select. For example, tap *Stakeout / Points / Add / Select from list / Filter*.

Tap an item to select it. Tap it again to clear it. A check mark beside an item shows that it is selected.

Use the *All* and *None* softkeys to aid selection.

The icons that appear in many parts of the Trimble Survey Controller software are shown below. For example, point lists, map graphics, point manager, and job review.

Icon	Description	Icon	Description
×	Topo points (GPS)	⊞	Rapid points
✕	F1 Topo points (Conv.)	*	Laser points
✕	F2 Topo points (Conv.)	✕	Resection points
∇	Mean turned angle	▪	Continuous points
‡	As-staked points	⊞	Copied control points
●	Keyed in points (normal)	⊞	Copied construction points
▲	Keyed in points (control)	⊞	Copied normal points
⊞	Calibration points	⊞	Copied as staked points
□	Cogo points (computed)	↻	Adjusted points
▪	Construction points	⊞	Copied adjusted points
⊞	Observed control points	↻	Lines
▲	FastStatic points	↻	Arcs
⋈	Base points	✓	Check points
♦	Linked file points	○	Offset points
⊕	Intersection points		

Note - Face 1 and Face 2 Topo points may be suffixed by a number 1 to 5, for example ✕³. The number represents the target number used with that observation.

Tip - The display of maps (.dxf and .shp), Alignments (.rxl) and Trimble roads (.rxl) can be controlled through:

- ◆ Select *Files / Properties of current job / Active map*.
- ◆ Tap the *Map* button, tap the *Up* softkey to access additional softkey functions and then tap *Layers*.

Using the Map for Common Tasks

To select a feature from the map, do one of the following:

- Tap the required feature(s) from the map area. If there is more than one feature in the highlighted area, a list of features in this area appears. Select the features as required and then tap *OK* to return to the map.

Tip - When selecting a line, arc, or polyline to stakeout, tap near the end of the line, arc, or polyline that you want to designate as the start. Arrows are then drawn on the line, arc, or polyline to indicate

the direction.

If the direction of the line, arc or polyline is incorrect, tap the line, arc or polyline to deselect it and then tap it at the correct end to reselect the direction required.

The direction of Alignments and Trimble roads is defined when they are created, and cannot be changed.

Note - The offset directions are not swapped when the line direction is reversed.

- Drag a box around the features you want to select.

When multiple features are selected in this way they are typically sorted in the order in which they are stored in the database. If the order of the entities in the selection is important, you should select them one by one.

To select a feature from a map file, the map file or layers must be made selectable.

To deselect a feature from the map, do one of the following:

- Tap the selected feature to deselect it. If there is more than one feature within the highlighted area, a list of features within this area appears. Deselect the features as required. Tap *OK* to return to the map.
- Tap and hold on the map and select *List selection* from the shortcut menu. A list of the selected features appears. Deselect the features as required.
- To clear the entire selection, double-tap off the selected features. Alternatively, tap and hold on the map and select *Clear selection* from the shortcut menu.

To carry out a task using the selected feature(s), do one of the following:

- Measure
 - ◆ If there are no features selected, tap *Measure* to measure the current position.
 - Tip** - To change the code when using *Measure* from the map, make sure that there are no features selected, then tap and hold on the map and select *Set point code*.
- Stakeout
 - ◆ If one or more features are selected, tap *Stakeout* to stake out the selected feature(s).
If more than one point is selected, the points are added to the *Stake out points* list, from where you can select them for stakeout.
 - ◆ If more than one line or arc is selected, the first item selected is the one used for stakeout.
 - ◆ Double-tap a feature to stake out.
If there is more than one feature within the highlighted area, a list of features within this area appears. Select the feature to stake out.
 - Tip** - If two points are selected, tap and hold on the map and then select *Stake out line* to stake a line defined by the two selected points.

If the selection contains different feature types (points, lines, arcs), only features of the first type selected can be staked out from the map. To stake out other feature types, clear the selection then

reselect the other features.

Tap and hold shortcut menu in the map

Tap and hold on the map area to access a shortcut menu. The shortcut menu provides quick access to common tasks. The tasks depend on the number and type of features selected.

In the following table, the * symbol against a task shows that you can access it through the shortcut menu for the feature at the top of that column.

Tap and hold menu options that are available for features in the current job:

Task	Feature					
	No Features	One point	Two points	Three or more points	Line	Arc
Review	-	*	*	*	*	*
List section	-	*	*	*	*	*
Clear section	-	*	*	*	*	*
Widescreen	*	*	*	*	*	*
Delete	-	*	*	*	*	*
Stake out points	-	*	*	*	-	-
Stake out line	-	-	*	-	*	-
Stake out arc	-	-	-	*	-	*
Create/Offset alignment	-	-	*	*	*	*
Stake out alignment	-	-	*	*	*	*
Measure calibration point	-	*	-	-	-	-
Navigate to point	-	*	-	-	-	-
Turn to point	-	*	-	-	-	-
Compute inverse	-	-	*	*	-	-
Compute area	-	-	-	*	-	-
Subdivide a line	-	-	-	-	*	-
Subdivide an arc	-	-	-	-	-	*
Key in point	*	-	-	-	-	-
Key in line	-	-	*	-	-	-
Key in arc: 3 points	-	-	-	*	-	-
Key in arc: 2 points + center	-	-	-	*	-	-
Set point code	*	-	-	-	-	-

Tap and hold menu options that are available for features in a linked file or active map file:

	Feature
--	---------

	One active map or linked file point	Two active map or linked file points	Three or more active map or linked file points	Active map line	Active map arc	Active map polyline	Alignment	Trimble road
Review	*	*	*	*	*	*	*	*
List section	*	*	*	*	*	*	*	*
Clear section	*	*	*	*	*	*	*	*
Widescreen	*	*	*	*	*	*	*	*
Delete	-	-	-	-	-	-	-	-
Stake out points	*	*	*	-	-	-	-	-
Stake out line	-	*	-	*	-	-	-	-
Stake out arc	-	-	-	-	*	-	-	-
Create/Offset alignment	-	*	*	*	*	*	*	*
Stake out alignment	-	*	*	*	*	*	*	*
Stake out road	-	-	-	-	-	-	*	*
Measure calibration point	*	-	-	-	-	-	-	-
Navigate to point	*	-	-	-	-	-	-	-
Turn to point	*	-	-	-	-	-	-	-
Compute inverse	-	*	*	-	-	-	-	-
Compute area	-	-	*	-	-	-	-	-
Subdivide a line	-	-	-	-	-	-	-	-
Subdivide an arc	-	-	-	-	-	-	-	-
Key in point	-	-	-	-	-	-	-	-
Key in line	-	*	-	-	-	-	-	-
Key in arc: 3 points	-	-	*	-	-	-	-	-
Key in arc: 2 points + center	-	-	*	-	-	-	-	-
Set point code	-	-	-	-	-	-	-	-

Note - If you select a point with the same name as another point in the database, then select the *Review* or *Delete* option from the shortcut menu, a list of the duplicate points appears. Select the point you want to review or delete.

- Field fill-in. Enter feature names into fields by selecting from the map. Select the feature(s) from the map then select a survey function, such as Cogo or Stakeout. The selected feature(s) are automatically entered into the appropriate fields.

- Map selection list. The *Map selections option* is available on the right side of the feature name field when you have selected features from the map. Tap it to access the list of the selected features. Only features that are specific to the field are shown.

You cannot use Trimble Survey Controller to delete points from linked files. Points from linked files do not appear in the *Review* screen list of deleteable points.

Autopan

The Autopan function automatically centers the map using the current position. Autopan only operates when the current position appears within the selected map view.

To automatically view your current position:

1. In the Map of current job screen, tap the Up arrow.
2. Tap *Options*.
3. Select the *Automatic pan to current position* check box.
4. Tap *Accept*.

Units

You can specify the units, such as degrees and meters, used by the Trimble Survey Controller software.

You can also specify the order of the displayed coordinates, the type of coordinates, the way a slope grade is displayed, and how stationing values are displayed.

To configure the units display, select *Files / Properties of current job / Units* and change the fields as required.

The order for the displayed coordinates can be set to:

- North-East-Elev
- East-North-Elev
- Y-X-Z
- X-Y-Z

For the Y-X-Z and X-Y-Z options the convention used defines that the Y axis is the East axis and the X axis is the North axis.

The following table describes the coordinate view options.

Option	Description
WGS-84	View as WGS-84 Latitude, Longitude, and Height
Local	View as local ellipsoidal Latitude, Longitude, and Height

Grid	View as Northing, Easting, and Elevation
Station and Offset	View as station, offset, or vertical distance relative to a line, arc, alignment, road, or tunnel
Az VA SD	View as azimuth, vertical angle, and slope distance
HA VA SD (raw)	View as horizontal angle, vertical angle, and slope distance
Az HD VD	View as azimuth, horizontal distance, and vertical distance
HA HD VD	View as horizontal angle, horizontal distance, and vertical distance
Delta Grid	View as differences in Northing, Easting, and Elevation from the instrument point

In some fields (for example, *Azimuth*), you can enter a value in units other than the system units. The *Units* softkey appears in these fields. When you tap *Enter* to accept the field, the value is converted to the system units.

The grade of a slope can be displayed in one of the following formats: angle, percent, or ratio. The ratio can be displayed as *Rise:Run* or *Run:Rise*.

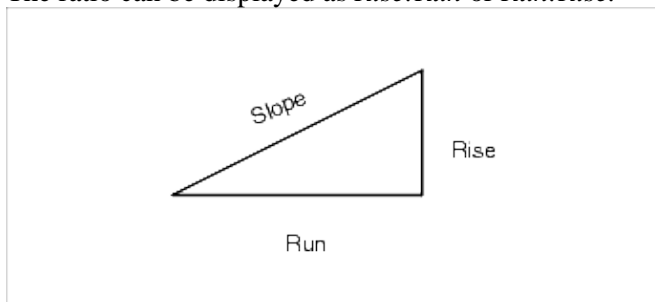

The setting in the *Laser VA display* field determines whether the laser measurements are displayed as vertical angles measured from the zenith, or inclinations measured from horizontal.

Linked Files

You can link files (*.csv, *.txt, or *.job) to your current job to provide easy access to additional data.

Note - A linked file must be saved to the same folder as the job that you are trying to link it to.

Note - In a linked job, you cannot access roads, lines, or arcs.

Use a linked file to access points that do not exist in the current job, or that you do not want to import into the current job. Linked CSV points appear as a comma (,). Linked points from another job appear with their original point symbol. All linked points appear blue. You can use points from a linked file to:

- stake out without having the design points in the job
- enter values into *Point name* fields, such as for Cogo functions
- navigate to control or check shots from previous surveys

Notes

- You can only review points in a linked file from the map. Once you select a linked point and copy it into the

current job, it appears as a "c" in the map.

- You can link multiple files (*.csv *.txt *.job). When the point does not exist in the current job, but does exist in multiple linked files, the point in the first linked file is used. If multiple points of the same name exist in a linked job, the [search rules](#) work within that job to find the best point.

Transferring linked files

You can transfer linked CSV files from the office computer, transfer files between controllers, or export points to a CSV file from a previous job.

Linked files must be saved to the same folder as the job that you are trying to link them to. If you export a CSV file using the Trimble Survey Controller software, it is saved to the [Export] folder. To link the file, use Explorer to move or copy the file to the appropriate project folder.

Before you transfer a CSV file, make sure the data in the file is in the format: Point name, First ordinate (Northing or Easting), Second ordinate (Northing or Easting), Elevation, Point code.

Note - The coordinate order (Northing and Easting ordinates) in the comma delimited file must be the same as the setting in the *Coordinate order* field in the *Units* screen.

Use the Data Transfer utility or Microsoft ActiveSync technology to transfer the file from the office computer to the Trimble controller. For more information, see [Transferring files between the controller and the office computer](#).

To transfer files between controllers, use the controller's *File Transfer Application*. Select *Files / Import/Export / File Transfer Application*.

For more information, see [File Transfer Application](#).

To select linked files:

1. From the Trimble Survey Controller main menu, select *Files / Properties of current job* and tap the *Linked files* button. The *Linked files* screen appears.
2. Tap the file(s) that you want to use for the current job or tap *All* to select all files.

To import points from a linked file to the current job, select *Files / Import/Export / Receive data from another device*.

When using points from linked files, make sure that they use the same coordinate system as the job that they are being brought into.

Staking out points from a linked file

To stake out a point from a linked file, do one of the following:

- From the [map](#), select a point to stake out.
- Add a point to the [Stake out points](#) list using the *Select from file* option.

Tip - When you add points to the stakeout list using the *Select from file* option, you can now add points to the stakeout list from the linked file even if the point in the linked file already exists in the current job. The *Select from file* option is the only way you can stake a point from a linked file when a point of the same name exists in the current job.

Entering point name fields

To enter a point from a linked file into a *Point name* field, access the field and key in the point name. A linked point entered into a point name field is copied into the current job database.

Active Map

The Trimble Survey Controller Map is a powerful feature that can be used to perform many tasks that are also available from the menu system. You can link other jobs and csv and txt files under the *Linked files* setting in *Properties of current job* and you can also attach other external files to the Active Map, either from *Properties of current job* or from within the Map using the *Layers* softkey.

Trimble Survey Controller software supports the display of the following active map files:

- AutoCAD (ASCII) files (.dxf)
- ESRI shape files (.shp)
- Alignments files (.rxl)
- Trimble roads (.rxl)
- Digital terrain models (.dtm .ttm)

Layers and selectability

Files that support layers enable you to control visibility and selectability in each layer. If there are no layers, you can control the visibility and selectability of the entire file.

The following file types support layers:

- AutoCAD (ASCII) files (.dxf)

The following file types do not support layers:

- ESRI shape files (.shp)
- Alignments files (.rxl)
- Trimble roads (.rxl)
- Digital terrain models (.dtm .ttm)

Selectable features in map files can be used in the following operations:

- Navigate to a point
- [Stakeout - points](#)
- [Stakeout - lines](#)

- Stakeout - arcs
- Stakeout - alignments (polylines)
- Stakeout - Trimble roads
- Stakeout - Digital terrain models
 - To see cut or fill values relative to a DTM, make the DTM file active/selectable.
- Active map lines, arcs, and polylines can be selected for stakeout only from the map.
- Cogo calculations - points only
- Active map lines and arcs cannot be used in Cogo calculations
- Review from the map

Note - You can now stake polylines contained in DXF and SHP files - they are no longer exploded into individual line and arc segments. However, if you do want to explode polylines, enable the *Explode polylines* check box in *Map / Layers / Options*.

Colors in the Map

Points, lines, and arcs in the current job database appear in black.
 Active points in map files appear in blue.
 Lines and arcs appear in the colors defined in the map file.

Feature code processing colors appear in the color defined in the Feature code file (.fxl files from Trimble Business Center only).

Transferring and selecting maps

1. To transfer the files to the controller, use the Trimble Data Transfer utility or Microsoft ActiveSync technology.
2. To select a map to view in the **Map of current job** screen, do one of the following:
 - ◆ Select *Files / Properties of current job / Active map*.
 - ◆ Tap the *Map* button, tap the Up softkey to access additional softkey functions and then tap *Layers*.

All map files appear in a tree list view.

Note - A map file must be saved to the same folder as the job you are trying to link it to.

3. The following table shows how to display, make selectable, and disable active map files and layers:

Tap...	
+	to expand the file to display all layers
-	to minimize the file and hide all layers
the file name	once to display all layers within the map file
	again to make all layers within the map file selectable
	again to disable all layers within the map file
the layer name	once to display all layers within the map file
	again to make all layers within the map file selectable
	again to disable all layers within the map file

<i>All</i>	once to display all layers within the map file
	again to make all layers within the map file selectable
<i>None</i>	to deselect all files and layers

Once the file is loaded, you can switch between the map view and the select map file screen and then select or deselect the layers you want to view.

The following table explains the icons that appear beside the file names.

File icon	Layer icon	indicates...
No icon	-	the file is not selected
×	-	the file has been loaded but there are no supported entities in the file to display
✓	-	some layers are visible in the map but nothing can be selected
✓	-	all layers with supported entities are visible in the map, but nothing can be selected
☒	-	some layers are not visible in the map, but others are both visible and can be selected
☑	-	all layers with supported entities are visible in the map, and some of those can also be selected
☑	-	all layers with supported entities are visible in the map and can be selected
-	No icon	the current layer is not visible in the map
-	×	there are no supported entities in the layer to display
-	✓	the current layer is visible in the map
-	☑	the current layer is visible and selectable in the map

Notes on active maps

- If the selectable icon does not appear beside the layer name, the layer does not contain any features that can be selected.
- A name is generated for every selectable feature within the map file. The first five characters are derived from the map file name, followed by a space and an autogenerated number. For DXF and Shape files, the autogenerated number is the line number in the original file where this feature is defined.
- A code can be generated for every selectable feature within a map file. This is derived from the attributes stored in the DXF file; often, it is the name, code, and attributes of features in the original file.
- You can review a selectable feature in the map to find the file and layer name.
- Map files are loaded into the job when the map is opened or when the map selection screen is opened.
- You can display more than one map at a time.
- Map features can be made visible and selectable but they can not be edited or deleted.
- Supported DXF entities are: [3D FACE, ARC, CIRCLE, INSERT, LINE, LWPOLYLINE, POINT, POLYLINE, SPLINE, SOLID, ATTRIB, TEXT, MTEXT].
- Supported Shape entities are: [Null shape, Point, PolyLine, Polygon, MultiPoint, PointZ, PolyLineZ, PolygonZ, MultiPointZ, PointM, PolyLineM, PolygonM, MultiPointM, MultiPatch].

Using a Feature and Attribute Library

To select a code in a survey, first select the library that you want to use:

1. From the main menu, select *Files / Properties of current job*.
2. Tap the *Feature library* button and select the library that you want to use.

Note - Feature and attribute libraries cannot be used in Description fields.

To choose a code from the library:

1. In the *Code* field, enter the first character of the required feature code. The feature code list is filtered according to the type of controller that you are using and the Auto-complete setting:

Trimble controller	Auto-complete on	Auto-complete off
TSC2	The feature code list is always filtered according to the characters that you enter. When you type a character, the first available code that starts with that character appears.	The feature code list is always filtered according to the characters that you enter. Only the character that you enter appears and is used to filter the feature code list.
Trimble CU	You do not need to put the controller into alpha mode to select an alpha code. The feature code list is filtered according to the characters available on the controller key that you pressed. For example, if you press "2", the list is filtered on a "2", and the associated keypad characters "T", "U", and "V". The first available code that starts with one of these characters appears.	The Trimble Survey Controller software maintains the alpha or numeric setting. Only the character that you enter appears and is used to filter the feature code list.

2. To further filter the feature code list, enter additional characters. Use the arrow keys to scroll to the required code, or if the required code is already displayed, tap *Enter* to accept this code and move to the next field.

When you select a code from the list, filtering is disabled and the entire feature code list appears, which allows you to select another code.

To enter multiple codes, select each code in turn from the list.

As you select multiple codes from the list, the system automatically enters a space to separate the codes. If you enter codes through the controller keypad, you must enter a space after each code to display the entire code list again before you enter the next code.

The maximum number of characters in a code field is 42.

Note - If a feature code list is already selected for the job, you can use codes from the list when keying in a note. From the *Note* screen, press *Space* to display the feature code list. Select a code from the list or type the first few letters of the code.

How to use the Code field when using feature code libraries

Feature code entry has been improved to make selection faster and more flexible.

If you use a feature and attribute library, when you access the code field on forms in the Trimble Survey Controller software, a *Code list* dialog appears with special controls to help you select codes from the feature code list.

Selection improvements in the code field:

- To select the entire code in the code list window, click anywhere in the code field, or press the controller left or right arrow when on a code field.
- A partial selection made in the code field is retained in the *Code list* dialog.

When the *Code list* dialog is active:

- To replace the code:
 - ◆ Select a code from the list when the entire code is highlighted (with an unfiltered list)
 - ◆ Select a code from the list when the highlight or cursor is within a code (with a filtered list).
- To add a code:
 - ◆ Select a code from the list when the cursor is at the start or end of a code (with an unfiltered list).

Note - Spaces are automatically entered to separate multiple codes.

Filtering improvements in the *Code list* dialog:

- The code list is filtered according to the characters to the left of the cursor or highlight.
- If the cursor is at the beginning or end of the code field and editing is not in progress, the code list is not filtered.

Using a touch screen to replace a code:

1. Tap in the code field. The code field is highlighted.
2. Use the scroll bar to scroll to the new code and then tap to select the new code you want to replace the old code.
3. To exit the *Code selection* dialog, tap *Enter*.

Using a touch screen to add to an existing code:

1. To open the *Code list* dialog, tap in the code field.
2. To remove the highlight on the code field before you select the new code, tap at the beginning or end of the code field.

The Trimble Survey Controller software automatically inserts spaces to separate multiple codes.

Using a keyboard to replace code:

1. Tab or arrow to the code field.
2. Press the key representing the first character of the code. The code list is filtered on that first character.
3. Depending on the size of your code library, do one of the following:
 - ◆ If the required code is not visible, press the key(s) representing the next character(s) of your code to further filter the list.
 - ◆ If the required code is visible, arrow down to the code, press *Enter* to select the code and then press *Enter* again to exit the dialog.

Using a keyboard to add to an existing code:

1. To open the *Code list* dialog, press the right arrow.
2. To remove the highlight on the code field before you select the new code, press the right arrow again.

The Trimble Survey Controller software automatically inserts spaces to separate multiple codes.

Tips

- To edit an existing code, use the arrow keys to navigate to the correct position and then use the backspace key to remove unwanted characters. As the code is modified, the code list filters accordingly.
- When auto-complete is turned off, recently used codes appear at the top of the code list. Multiple entry codes are remembered as a single entry in the recently used list. This allows you to quickly select recently used codes, especially multiple code entries.
- To enter a code that is not in the library, but which has a similar entry in the library, press the space key to accept the code that you enter not the similar code from the library. Alternatively, turn off auto-complete.

When you use a feature code that has attributes, the Trimble Survey Controller software prompts you to enter the attribute data.

Using Feature Codes with Predefined Attributes

You can use feature and attribute libraries that were created using the Trimble Geomatics Office software, the Feature and Attribute Editor or Data Dictionary Editor utilities, to store additional attribute information for feature codes. In the Trimble Survey Controller software, these feature codes have an attribute icon () next to the feature code in the library.

The following office software packages can store additional attribute information for feature codes in feature and attribute libraries and transfer these to the Trimble Controller.

To create a library, use ...	To transfer a library, use ...
------------------------------	--------------------------------

Feature and Attribute Editor	Trimble Geomatics Office
Feature Manager (Trimble Business Center)	Feature Manager

In the Trimble Survey Controller software, feature codes with attributes have an attribute icon () next to the feature code in the library.

Note - Feature codes created using the Trimble Survey Controller software do not have attributes associated with them.

Note - Feature classifications defined in feature and attribute libraries as Point, Line, or Area in the office software all appear as *Point features* in the Trimble Survey Controller software.

Tip - To capture attribute data more efficiently, use the office software to predefine default values, minimum and maximum ranges, auto-generated times and dates, and well-structured menu options. If you use auto-generated times, make sure that the time is set correctly on your Trimble controller. For information on setting the Trimble controller time and date, refer to [Time and date](#).

Note - If you specify in the office software that field entry is not permitted for an attribute, you cannot use the Trimble Survey Controller software to enter that attribute data.

Note - You can now change the feature and attribute library assigned to a job after the attributes have been stored. If the feature and attribute library that was used to assign the attributes is no longer linked to the job, the attributes can be viewed but they cannot be changed. However, you can select a new code from the library and then change the attributes.

When you change feature and attribute libraries assigned to a job, please ensure that the appropriate library is assigned to the office software so that the feature codes and attributes can be correctly processed.

In the Trimble Geomatics Office software, the database tables that hold the attribute information are created when you assign the feature and attribute library to the project. If you assign a new feature and attribute library to a Trimble Survey Controller job, and the library includes features and attributes that were not present in the library that you used to set up the Trimble Geomatics Office project, the system ignores these features and attributes when it imports the library to the project.

To enter attributes before measuring a point:

1. Enter the feature code and tap the *Attrib* softkey. A screen with the feature code and attribute fields appears.
2. Enter values in the attribute fields.

The maximum number of characters in text attribute fields is usually 100. Your definition of a feature and attribute library can specify fewer.

Tip - If the feature has been used in the current job, the last stored set of attributes for the current feature are the defaults. Tap *Default* to set the defaults from the library.

The *Prev* and *Next* softkeys appear when there are multiple feature codes with attributes in the *Code* field. Use

them to swap between attributes.

To enter attributes while measuring a point:

1. Enter the feature code. The *Attrib* softkey appears.
2. Tap *Measure* to start measuring the point.

A screen with the feature code and attribute fields is displayed.

3. Enter values in the attribute fields. Tap *Store* to accept the attributes.

Tip - The Trimble Survey Controller software can automatically store the point while you are still entering attribute data. To enable this, select the *Auto store point* check box in the survey style.

Prompt for attributes option

When you store points with attributes in *Measure topo*, you can disable the *Prompt for Attributes* check box in the *Options* screen. This stops the Trimble Survey Controller software from prompting you to enter the attributes on every point that you store in the *Measure topo* screen (and when you measure a topo point from the map). The software completes the attributes with the default values or the previously used attributes for a particular feature code. To change the attributes, use the *Attrib* softkey. Subsequent points that have the same feature code will use the newly entered attributes. If there are any feature codes that have required attribute fields without default values or previously defined values, the software prompts you for attributes the first time that you store a point with that particular feature code.

Notes

- During normal operation, the Trimble Survey Controller software always prompts you to enter point attributes. The option to turn off *Prompt for Attributes* is available when you measure conventional topo points from *Measure topo* or from the map, or measure GPS points from *Measure points*, or from the map.
- In *Continuous topo*, when you measure points using a code that has attributes, and *Prompt for Attributes* is switched ON, you are only prompted for attributes once, when you enter the code.

Entering attributes for a point using feature codes without predefined attributes

You can enter several attributes for one point. For a point that has a feature code of Tree, for example, you can enter its type, height, girth, and spread as attributes.

To enter attributes for a point using the colon (:) key:

1. Measure, key in, or compute the point.
2. Tap *Favorites* and select *Key in note*.
3. Enter the first attribute and press the colon key (:). Enter the data and press : again.
If a feature code and attribute library is selected for the job, the code list appears when you press the space key.
4. Enter the next attribute and press the colon (:) key. The attributes for a tree, for example, could be:
Type:Oak:Girth:1.0:Height:15:Spread:12
5. Repeat step 4 until all attributes are entered and then tap *Enter*.

Tip - Use the *Switch to* softkey to return to the screen where you stored the point without closing this window.

Note - Attributes collected using note records with "." separators are processed as note records in the Trimble Geomatics Office software. For more flexibility in the office software, collect attributes using attribute subrecords or features from the feature and attribute libraries created in the office software.

To edit a Code once a point has been measured:

1. Select *Files / Review current job* or *Files / Point manager*.
2. Edit the code field for the point.

Resurveying points that already have attributes

To stake out and re-measure points for which you already have attribute data:

1. If the job is not yet in the Trimble Survey Controller software, transfer it from the Trimble Geomatics Office software.

Note - Transfer relevant features and attributes as well as the points.

2. From the main menu, select *Survey / Survey style / Stakeout*.
3. Tap *Options* and set the as-staked point details:
 - ◆ Set the *As-staked* name field to *Design name*.
 - ◆ Set the *As-staked* code field to *Design code*.
4. Stake out the point.
5. Measure the as-staked point.

The attribute data displayed for the point is the attribute data that you entered previously. The defaults in the feature and attribute library are not used. Update the values as required.

High Accuracy GIS

With the High Accuracy GIS option enabled:

- The 'file name' attribute fields include a **Browse** button () that enables you to find and select a file name as an attribute.
- You can export ESRI shapefiles on the Trimble Survey Controller software using *Export fixed format file / ESRI Shapefiles*, or you can create ESRI Shapefiles using the Trimble Data Transfer utility.

To order the High Accuracy GIS option, contact your Trimble dealer:

Item	Part number
High Accuracy GIS Option with the New Trimble Survey Controller	90100-05
	90100-04

Using File name attributes

Use the *File name attribute* field to link a file name to an attribute. You can use file name attributes for any type of file, but typically when linking .jpg/.jpeg photographs.

When the High Accuracy GIS option is not enabled, the file name attribute is a simple text field. You can key in the file name.

When the High Accuracy GIS option is enabled, tap the Browse button () to open a dialog and then do one of the following to select the required file:

- Tap the file.
- Use the arrow key to highlight the file and then tap **OK**.
- If selecting a .jpg/.jpeg file, tap and hold with the stylus on the file and then select *Preview*. Tap *Select* to select the current file, or tap *Prev* or *Next* to preview another file.

If you select a .jpg/.jpeg file, an option to *Review* the selected file becomes available from the Browse button. To change your selection, tap  and then tap *Select file*.

Once you select an image from a folder, it becomes the default folder the next time you select an image.

When selecting the file, the available "tap and hold" options are: Select, Preview, Cut, Copy, Paste, Rename, Delete, Create folder, and Properties.

Tips

- To sort a column in ascending or descending order, tap the column header.
- An arrow beside the column title indicates the sort order.
- To quickly select the latest file, sort on *Modified* date and time. If the oldest files appear at the top of the list, click *Modified* again to reverse the sort order.

To create a file name attribute in the feature and attribute library, use the Feature and Attribute Editor and then transfer the file to the controller using the Trimble Geomatics Office software.

Notes

- Feature and attribute libraries created using the Trimble Business Center Feature Manager software do not currently support file name attributes.
- Feature codes created using the Trimble Survey Controller software do not have attributes associated with them.

Using a digital camera and linking digital images

With some brands of digital camera, you can take photographs and then wirelessly transfer them to the controller. When the High Accuracy GIS option is enabled on the controller, you can then preview and select the files as attributes of a feature code.

Note - You can connect a TSC2 controller to a WiFi capable digital camera. Alternatively, you can insert the CF or SD card from the digital camera into an available port on the controller.

Supported WiFi Cameras

You can use a TSC2 controller with the following WiFi cameras:

Camera	Protocol
Nikon COOLPIX P1	TrimPix
Nikon COOLPIX P2	TrimPix
Nikon COOLPIX P3	TrimPix
Nikon COOLPIX S6	TrimPix
Nikon COOLPIX S7c	TrimPix
Ricoh Caplio 500SE-W	FTP

Notes

- For information on installing and configuring TrimPix technology on the controller, refer to the *TrimPix Technology Getting Started Guide*.
- For more information, refer to the support note *Trimble Handhelds Running Windows Mobile Version 5.0 Software: Connecting a Ricoh Caplio 500SE-W Camera*.

Setting the default attributes option

You can configure the Trimble Survey Controller software to use **Last used** attributes, by default. To do this, tap *Options* (available when the attributes appear) and then set the *Default attributes* field to *Last used*.

You can configure the Trimble Survey Controller software to use attributes from the Feature and attribute library, by default. To do this, tap *Options* (available when the attributes appear) and then set the *Default attributes* field to *From library*.

Note - You must first define the default attributes in the Feature and attribute library, or default values will be null

Using Description Fields

You can choose to display two additional description fields in many functions within the Trimble Survey Controller software.

The description fields are similar to code fields because they enable you to add additional information to data. They do not use feature code libraries, and they do not support attributes.

The description field data is available in Trimble DC files as Note records.

You can also export the data stored in the description fields using [Export Custom Format Files](#).

To enable and customize the description fields:

1. From the main menu, select *Files / Properties of current job*.
2. Tap the *Page down* button and then tap the *Descriptions* button.
3. Select the *Use descriptions* check box.
4. If required, enter a new name for *Description 1 label* and *Description 2 label*.
5. Tap *Accept*.

Once the additional descriptions fields are enabled, they are available in the following features of the Trimble Survey Controller software:

- Station setup
- Measure topo
- Measure codes
- Continuous topo
- Stakeout
- Point manager
- Review current job
- Key in point, line, and arc
- Compute point
- Compute average
- Transformations
- Traverse

Each of the two description fields remembers the descriptions that are entered. To view the stack of previously used descriptions, tap the arrow on the description field.

The description stack is unique for each description field. The description stack is stored to the [descriptions.xml] file in the Trimble data folder on the controller. You can edit it with a text editor, and copy it to another controller.

Copy Between Jobs

To copy a calibration, control points, or points from one job to another job on the controller:

1. Select *Files / Copy between jobs*.
2. Select each of these items:
 - ◆ a job name in the *Job to copy from* field.
 - ◆ a job name in the *Job to copy to* field.
 - ◆ the items to be copied in the *Copy* field.

If you select the *Copy duplicate points* check box, the option to *Overwrite* appears.

3. If you want to copy duplicate points, and overwrite and delete the duplicate points in the job you are copying to, select the appropriate check boxes.
4. When the *Copy* field is set to *Points*, various point selection options become available in the *Select Point* menu. Select the appropriate option.

When copying points between jobs, make sure that the points you are copying use the same coordinate system as the job that the files are being brought into.

Note - You can only copy information between jobs that are in the current project folder. If the file(s) you want to copy data between are not available, use Job open to change the current project folder, or use Explorer to copy the file(s) to the current project folder.

To create a new job with **all** the defaults (including Coordinate System settings) from another job, see [Job operations](#).

Key In

Key in Menu

This menu lets you enter data into the Trimble Survey Controller software from the keypad. You can key in points, lines, arcs, alignments, roads, tunnels, and notes.

For more information, see:

[Points](#)

[Lines](#)

[Arcs](#)

[Alignments](#) (polylines)

[Roads](#)

[Tunnels](#)

[Notes](#)

Key in - Points

With this function, you can enter coordinates to define a new point:

1. From the main menu, select *Key in / Points*.
2. Enter the point name.
3. Enter the values.
4. Tap *Store* to calculate or store the point.

To enter a point from the map:

1. Make sure the current selection is cleared.
2. Tap and hold on the area of the map to which you want to add the point.
3. From the shortcut menu, select *Key in point*. The *Key in / Point* screen appears.
4. Complete the fields as required.

Key in - Lines

Use this function to define a new line by one of the following methods:

Two points

Brng-dist from a point

To define a new line by the Two points method:

1. Do one of the following:
 - ◆ From the map, select the *Start point (1)* and the *End point (2)*. (See the diagram below.) Tap and hold on the map and select *Key in line* from the shortcut menu.
 - ◆ Select *Key in / Line* from the main menu. In the *Method* field, select Two points. Enter the names of the *Start point* and the *End point*.
2. Use *Options* to specify ground, grid, or sea level distances.
3. Enter the name of the line.
4. For stationing, enter a value for the *Start station* and the *Station interval*.

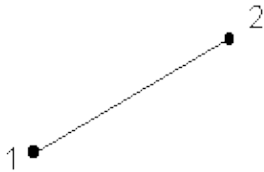

To define a new line by the Brng-dist from a point method:

1. From the main menu, select *Key in / Line*.
2. Use *Options* to specify ground, grid or sea level distances.
3. Enter the name of the line.
4. In the *Method* field, select *Brng-dist from a point*.
5. Enter the name of the Start point (1), the azimuth (2), and the length of line (3). See the diagram below.
6. Specify the *Grade* between the start and end points.
7. For stationing, enter a value for the *Start station* and the *Station interval*.

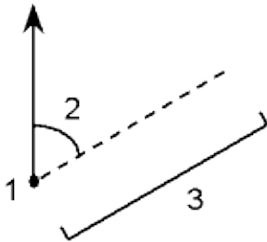

Key in - Arcs

Use this function to define a new arc by one of the following methods:

Two points and radius

Arc length and radius

Delta angle and radius

Intersect point and tangents

Two points and center point

Three points

The following diagram and table explains the terms used to define features of an arc.

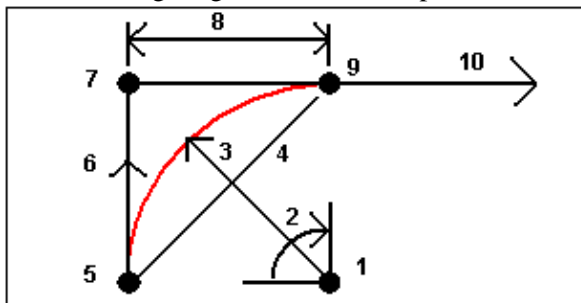

1	Center point	6	Back tangent
2	Delta angle	7	Intersection point
3	Radius	8	Tangent length
4	Chord length	9	Forward tangent
5	From point	10	To point

The back tangent value (6) is related to the direction (right in the above diagram) in which the stationing or chainage increases. For example, when you stand at the intersection point (7) looking in the direction of increasing stationing or chainage, the forward tangent (9) is in front of you and the back tangent (6) is behind you.

The direction field defines whether the arc turns to the left (counterclockwise) or right (clockwise) from the start point (1) to the end point (2). The following diagram shows both a left (3) and right (4) arc.

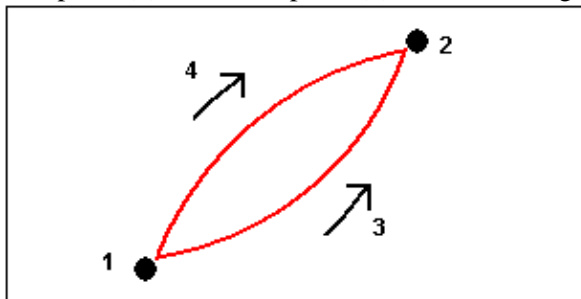

To define an arc using the Two points and radius method:

1. From the main menu, select *Key in / Arc*.
2. Use *Options* to specify ground, grid, or sea level distances.
3. Enter the name of the arc.
4. In the *Method* field, select *Two points and radius*.
5. As shown in the diagram below, enter the name of the start point (1), the name of the end point (2), and the radius (3) of the arc.
6. Specify the direction of the arc.
7. For stationing, enter a value for the start station and the station interval.

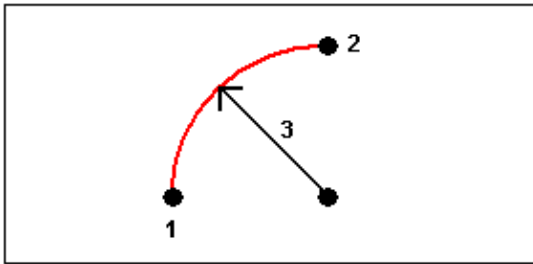

To define an arc using the Arc length and radius method:

1. From the main menu, select *Key in / Arc*.
2. Use *Options* softkey to specify ground, grid, or sea level distances and the grade entry method.
3. Enter the name of the arc.
4. In the *Method* field, select *Arc length and radius*.
5. As shown in the diagram below, enter the name of the start point (1), the back tangent (2), the radius (3) and the length of the arc.
6. Specify the direction of the arc and the grade between the start and end points.
7. For stationing, enter a value for the start station and the station interval.

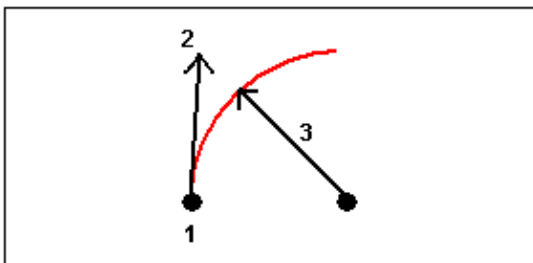

To define an arc using the Delta angle and radius method:

1. From the main menu, select *Key in / Arc*.
2. Use *Options* to specify ground, grid, or sea level distances and the grade entry method.
3. Enter the name of the arc.
4. In the *Method* field, select *Delta angle and radius*.
5. As shown in the diagram below, enter the name of the start point (1), the back tangent (2), the radius (3) and the turned angle (4) of the arc.
6. Specify the direction of the arc and the grade between the start and end points.
7. For stationing, enter a value for the start station and the station interval.

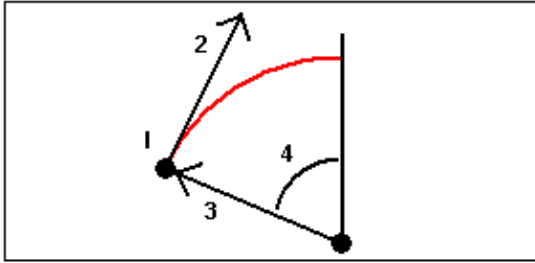

To define an arc using the Intersect point and tangents method:

1. From the main menu, select *Key in / Arc*.
2. Use *Options* to specify ground, grid or sea level distances.
3. Enter the name of the arc.
4. In the *Method* field, select *Intersect point and tangents*.
5. As shown in the diagram below, enter the name of the intersection point (1), the back tangent (2), the forward tangent (3) and the radius (4) of the arc.
6. For stationing, enter a value for the start station and the station interval.

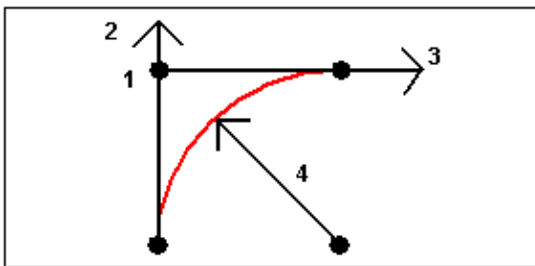

To define an arc using the Two points and center point method:

1. From the main menu, select *Key in / Arc*.
2. Use *Options* to specify ground, grid or sea level distances.
3. Enter the name of the arc.
4. In the *Method* field, select *Two points and center point*.
5. Specify the direction of the arc.
6. As shown in the diagram below, enter the name of the *Start point* (1), the *End point* (2), and the *Center point* (3) of the arc.
7. For stationing, enter a value for the start station and the station interval.

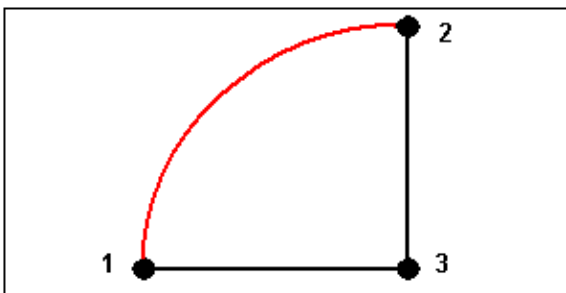

To define an arc using the Three points method:

1. From the main menu, select *Key in / Arc*.
2. Use *Options* to specify ground, grid or sea level distances.
3. Enter the name of the arc.
4. In the *Method* field, select *Three points*.
5. As shown in the diagram below, enter the name of the *Start point* (1), the *Point on arc* (2), and the *End point* (3) of the arc.
6. For stationing, enter a value for the start station and the station interval.

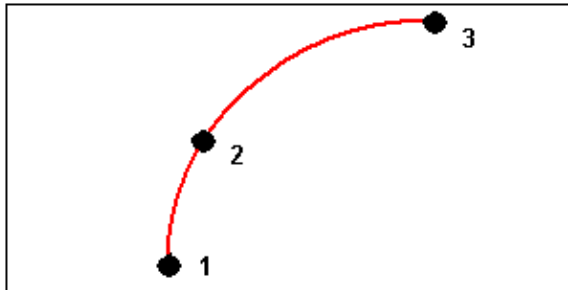

The grade of the arc is determined by the elevations of the arc start and end points.

Key in - Alignments

To key in an alignment by a point name range:

1. From the main menu, select *Key in / Alignments*.
2. To key in a new alignment, enter the point names that define the alignment (if the *Key in alignment* screen is displayed). If the *Select an alignment* screen is displayed, tap *New* to enter the point range.

The following name range techniques are supported:

Enter	Result
1,3,5	Creates a line between points 1 to 3 to 5
1-10	Creates lines between all points from 1 through 10
1,3,5-10	Creates a line between points 1 to 3, to 5, and 5 through 10
1(2)3	Creates an arc between points 1 and 3, through point 2
1(2,L)3	2 (Radius point), L (left) or R (right) Creates a Left hand arc between points 1 and 3, with point 2 as the radius point
1(100,L,S)3	1 to 3, radius=100, L (left) or R (right), L (large) or S (small) Creates a Left hand Small arc between points 1 and 3 with a radius of 100

3. To store the alignment, enable the *Store alignment* check box, enter an *Alignment name*, enter a *Code* and *Station interval* if required, and then tap *Store*.

Alignments are stored as RXL files. If you save the alignment, you can easily stake it again, view it in the map, and share it with other jobs and with other controllers.

Alignments always have a horizontal component; the vertical component is optional. If an alignment is created using entities that have elevations, the alignment will have a vertical component.

4. To offset an alignment, tap *Offset*.
5. Enter the offset distance.
To offset to the left, enter a negative value.
6. To store the offset alignment, enable the *Store alignment* check box, enter an *Alignment name*, enter a *Code*, if required, and then tap *Store*. The alignment is stored as an RXL file.
7. To store node points at the vertices of the offset alignment, enable the *Store points at nodes* check box, enter a *Start point name*, enter a *Code*, if required, and then tap *Store*.

An offset alignment will have a vertical component if the vertical geometry of the original alignment is coincident with the horizontal geometry and the vertical geometry consists only of points. The offset vertical geometry cannot include curves. If the vertical geometry of an alignment cannot be offset, only the horizontal component will exist in the offset alignment. You cannot offset an alignment that includes spirals.

For more information, see:

- [Stakeout - alignments](#) (polylines)

Key in - Roads

Use this option to:

- [Key in](#) and edit a Trimble road
- [Key in](#) and edit an Alignment
- [Create](#) and edit a group from a GENIO file

Keyed-in roads (known as *Trimble roads*) are saved to the current project folder as 'road name'.rxl. Trimble roads are available for all jobs saved to the current project folder.

Alignment files keyed in using [Key in road](#), or created from the map, or during [Stakeout Alignment](#) are saved as .rxl files in the current project folder.

To use a file saved to the current project folder in another project, use Windows Explorer to copy or move the file to the appropriate project folder.

Groups defined from a GENIO file are saved as a comment to the end of the GENIO file. GENIO files and associated groups are available for all jobs.

Trimble roads

To key in a Trimble road:

1. From the main menu, select *Key in / Roads*.
2. Tap *New* and enter a name for the road definition. (To edit an existing road, highlight the road name and tap *Edit*.)

Tip - Use the *Copy* option to copy an existing road definition with all its components into the current road.

3. Choose a component to key in:

Horizontal Alignment

Vertical Alignment

Template Positioning

Superelevation and Widening

Templates

Station Equations

4. Tap *Store* when all components have been defined.
5. Tap the *Report* softkey to generate a report of the offset, elevation, and code for each position in the cross section for the selected stations. The values reported are for the resolved cross sections, that is, they include any superelevation and widening values that may have been applied, and any interpolation between different templates.

Tip - Use *Rename* and *Delete* to rename or delete a road definition.

Notes

- The Trimble Survey Controller software treats all road distances, including stationing and offset values, as grid distances. The value in the *Distances* field (accessed by selecting *Files / Properties of current job - Cogo settings*) has no effect on the road definition or the way road distances are displayed.
- If a ground coordinate system is defined in either the Trimble Geomatics or Trimble Survey Controller software, then the grid coordinates are, in effect, also ground coordinates.
- Alignment files are saved as .rxl files - the same format as Trimble roads.
- Alignments can be created or edited using Key in Trimble roads.
- Alignment files created from the map, or during Stakeout Alignment, contain a Horizontal alignment. If elevations exist, the files also contain a Vertical alignment.

Horizontal Alignment

To add a horizontal alignment to a new road definition, select *Horizontal alignment*. You can enter the alignment using one of the following methods:

- ◆ **Length / Coordinates**
- ◆ **End station**
- ◆ **PI**

Entry by Length / Coordinates

To add a horizontal alignment to a new road definition by entering the lengths of the elements or the end coordinates, select *Horizontal alignment* and then do the following:

1. Tap *New* to enter the first element that defines the alignment. The *Element* field is set to *Start point*. You cannot change this.
2. Enter the *Start station*.
3. In the *Method* field, choose one of the following options:
 - ◆ *Key in coordinates*
 - ◆ *Select point*

If you choose the *Key in coordinates* method, enter values in the *Start north* and *Start east* fields. If you choose the *Select point* method field, enter a value in the *Point name* field. The *Start north* and *Start east* fields will update with the values for the entered point.

Tip - To edit the *Start north* and *Start east* values when they have been derived from a point, change the method to *Key in coordinates*.

4. Enter the *Station interval*. To add the horizontal element, tap *Store*.
5. To enter the next horizontal element, tap *New*. In the *Entry Method* field, select *Length/Coordinates* and then tap *OK*.
6. Select the *Element* and *Method*, enter the required information and then tap *Store*. For details on supported elements and entry methods, see the following:

Line elements

Arc elements

Entry spiral/Exit spiral elements

7. When you have entered the last element, tap *Accept*.

Tip - To delete an element, highlight it and tap *Delete*. When you add an element, it appears below the previous element that you added. To insert it at a particular place in the list, highlight the element that you want it to follow. Tap *New* and enter details of the element.

8. Enter the other road components or tap *Store* to store the road definition.

Line elements

If you select *Line* in the *Element* field, the *Start station* field displays the start station value for the line that you are defining. You cannot edit this.

The following table shows the available methods and the fields that appear when you select each one.

Method	Procedure
Azimuth and length	In the <i>Azimuth</i> and <i>Length</i> fields, enter values that define the line. The <i>End north</i> and <i>End east</i> fields update with the values entered.
End coordinates	In the <i>End north</i> and <i>End east</i> fields, enter values that define the line. The <i>Azimuth</i> and <i>Length</i> fields update with the values entered.
Select end point	In the <i>Point name</i> field, enter a value. The <i>Azimuth</i> , <i>Length</i> , <i>End north</i> , and <i>End east</i> fields update with the values entered.

Tip - For a line defined by *Azimuth and length*, the *Azimuth* field shows the azimuth as calculated from the previous element. To edit the azimuth, select *Edit azimuth* from the pop-up menu in the *Azimuth* field. If the element is non tangential, its icon is red. To reload the original azimuth, select *Restore tangency* from the pop-up menu.

Arc elements

If you select *Arc* in the *Element* field, the *Start station* field displays the start station value for the arc that you are defining. You cannot edit this.

The following table shows the available methods and the fields that appear when you select each one.

Method	Procedure
Radius and length	Specify arc direction. In the <i>Radius</i> and <i>Length</i> fields, enter values that define the arc.
Delta angle and radius	Specify arc direction. In the <i>Angle</i> and <i>Radius</i> fields, enter values that define the arc.
Deflection angle and length	Specify arc direction. In the <i>Angle</i> and <i>Length</i> fields, enter values that define the arc.
End coordinates	In the <i>End north</i> and <i>End east</i> fields, enter values that define the arc. The <i>Arc direction</i> , <i>Radius</i> , and <i>Length</i> fields update with the values entered.
Select end point	In the <i>Point name</i> field, enter a value that defines the arc. The <i>Arc direction</i> , <i>Radius</i> , <i>Length</i> , <i>End north</i> , and <i>End east</i> fields update with the values entered.
End coordinates and center point	In the <i>End north</i> , <i>End east</i> , <i>Center point north</i> , and <i>Center point east</i> fields, enter values that define the arc. If required select <i>Large arc</i> . The <i>Azimuth</i> , <i>Arc direction</i> , <i>Radius</i> , and <i>Length</i> fields update with the values entered.
Select end and center points	In the <i>End point name</i> and <i>Center point name</i> fields, enter values that define the arc. If required select <i>Large arc</i> . The <i>Azimuth</i> , <i>Arc direction</i> , <i>Radius</i> , <i>Length</i> , <i>End north</i> and <i>End east</i> fields update with the values entered.

Tip - For an arc defined by *Radius and length*, *Delta angle and radius* or *Deflection angle and length*, the *Azimuth* field shows the azimuth as calculated from the previous element. If the element is non tangential, its icon is red. To reload the original azimuth, select *Restore tangency* from the pop-up menu.

Entry spiral/Exit spiral elements

If you select *Entry spiral/Exit spiral* in the *Element* field, the *Start station* field displays the start station value for the entry spiral or exit spiral that you are defining. You cannot edit this.

Specify the arc direction. In the *Start radius*, *End radius* and *Length* fields, enter values that define the spiral.

The *End North* and *End East* fields update to display the coordinates at the end of the element just added.

The *Azimuth* field displays the azimuth as calculated from the previous element. To edit the azimuth, select *Edit azimuth* from the pop-up menu in the *Azimuth* field. The software indicates that the element is non tangential by coloring the element icon red.

Tip - To reload the original azimuth select *Restore tangency* from the pop-up menu.

Note - Spirals are defined as Clothoids.

Entry by End station

To add a horizontal alignment to a new road definition by entering end station values, select *Horizontal alignment* and then do the following:

1. Tap *New* to enter the first element that defines the alignment. The *Element* field is set to *Start point*. You cannot change this.
2. Enter the *Start station*.
3. In the *Method* field, choose one of the following options:
 - ◆ *Key in coordinates*
 - ◆ *Select point*

If you choose the *Key in coordinates* method, enter values in the *Start north* and *Start east* fields.

If you choose the *Select point* method field, enter a value in the *Point name* field. The *Start north* and *Start east* fields will update with the values for the entered point.

Tip - To edit the *Start north* and *Start east* values when they have been derived from a point, change the method to *Key in coordinates*.

4. Enter the *Station interval*. To add the horizontal element, tap *Store*.
5. To enter the next horizontal element, tap *New*. In the *Entry Method* field select *End station* and then tap *OK*.
6. Select the *Element* and *Method*, enter the required information and then tap *Store*. For details on supported elements and entry methods, see the following:

Line elements

Arc elements

Entry spiral/Exit spiral elements

8. When you have entered the last element, tap *Accept*.

Tip - To delete an element, highlight it and tap *Delete*. When you add an element, it appears below the previous element that you added. To insert it at a particular place in the list, highlight the element that you want it to follow. Tap *New* and enter details of the element.

9. Enter the other road components or tap *Store* to store the road definition.

Tip - Tap *Method* to change the entry method to *Length*.

Line elements

If you select *Line* in the *Element* field, the *Start station* field displays the start station value for the line that you are defining. You cannot edit this.

In the *Azimuth* and *End station* fields, enter values that define the line. The *End North* and *End East* fields update to display the coordinates at the end of the element just added.

If this line is not the first line to be defined, the *Azimuth* field displays an azimuth calculated from the previous element. To edit the azimuth, select *Edit azimuth* from the pop-up menu in the *Azimuth* field. The software indicates that the element is non tangential by coloring the element icon red.

Tip - To reload the original azimuth select *Restore tangency* from the pop-up menu.

Arc elements

If you select *Arc* in the *Element* field, the *Start station* field displays the start station value for the arc that you are defining. You cannot edit this.

The following table shows the available methods and the fields that appear when you select each one.

Method	Procedure
Radius and end station	Specify arc direction. In the <i>Radius</i> and <i>End station</i> fields, enter values that define the arc.
Deflection angle and end station	Specify arc direction. In the <i>Angle</i> and <i>End station</i> fields, enter values that define the arc.

The *End North* and *End East* fields update to display the coordinates at the end of the element just added.

The *Azimuth* field displays the azimuth as calculated from the previous element. To edit the azimuth, select *Edit azimuth* from the pop-up menu in the *Azimuth* field. The software indicates that the element is non

tangential by coloring the element icon red.

Tip - To reload the original azimuth select *Restore tangency* from the pop-up menu.

Entry spiral/Exit spiral elements

If you select *Entry spiral/Exit spiral* in the *Element* field, the *Start station* field displays the start station value for the entry spiral or exit spiral that you are defining. You cannot edit this.

Specify arc direction. In the *Start radius*, *End radius* and *End station* fields, enter values that define the spiral.

The *End North* and *End East* fields update to display the coordinates at the end of the element just added.

The *Azimuth* field displays the azimuth as calculated from the previous element. To edit the azimuth, select *Edit azimuth* from the pop-up menu in the *Azimuth* field. The software indicates that the element is non tangential by coloring the element icon red.

Tip - To reload the original azimuth select *Restore tangency* from the pop-up menu.

Note - Spirals are defined as Clothoids.

Entry by PI

To add a horizontal alignment to a new road definition by entering the points of intersection (PI), select *Horizontal alignment* and then do the following:

1. Tap *New* to enter the first element that defines the alignment. The *Element* field is set to *Start point*. You cannot change this.
2. Enter the *Start station*.
3. In the *Method* field, choose one of the following options:
 - ◆ *Key in coordinates*
 - ◆ *Select point*

If you choose the *Key in coordinates* method, enter values in the *Start north* and *Start east* fields. If you choose the *Select point* method field, enter a value in the *Point name* field. The *Start north* and *Start east* fields will update with the values for the entered point.

Tip - The selected entry method will be the default for subsequent elements. To change the entry method, select the *Method* option.

Tip - To edit the *Start north* and *Start east* values when they have been derived from a point, change the method to *Key in coordinates*.

4. Enter the *Station interval*. To add the horizontal element, tap *Store*.
5. To enter the next horizontal element tap *New*. In the *Entry method* field, select *PI* and then tap *OK*.
6. Tap *New* and select the *Curve type*, enter the required information, and then tap *Store*. For details on

supported curve types, see the following:

None

Circular

Spiral|Arc|Spiral

Spiral|Spiral

8. When you have entered the last element, tap *Accept*.

Tip - To delete an element, highlight it and tap *Delete*. When you add an element, it appears below the previous element that you added. To insert it at a particular place in the list, highlight the element that you want it to follow. Tap *New* and enter details of the element.

9. Enter the other road components or tap *Store* to store the road definition.

Curve type: None

Define the PI and then select *None* in the *Curve type* field.

Curve type: Circular

Define the PI and then select *Circular* in the *Curve type* field. Enter values defining the *Radius* and *Arc length* and then tap *Store*.

Curve type: Spiral|Arc|Spiral

Define the PI and then select *Spiral|Arc|Spiral* in the *Curve type* field. Enter values defining the *Radius*, *Arc length*, *Spiral length in*, and *Spiral length out* and then tap *Store*.

Note - Spirals are defined as Clothoids.

Curve type: Spiral|Spiral

Define the PI and then select *Spiral|Spiral* in the *Curve type* field. Enter values defining the *Radius*, *Spiral length in*, and *Spiral length out* and then tap *Store*.

Note - Spirals are defined as Clothoids.

Vertical Alignment

To add a vertical alignment to a new road definition, select *Vertical alignment*. You can enter the alignment using one of the following methods:

- **Vertical Points of Intersection**
- **Start and end points**

Note - The selected entry method applies to all elements defining the vertical alignment.

Entry by Vertical Points of Intersection (VPI)

To add a vertical alignment to a new road definition by entering Vertical Points of Intersection (VPI), select *Vertical alignment* and then follow these steps:

1. To enter the first element that defines the alignment, tap *New*.
2. In the *Station* and *Elevation* fields, key in the values that define the first vertical point of intersection. The *Element* field is set to *Start point*. You cannot change this.
3. Tap *Store* to add the vertical element record.
4. Tap *New*. In the entry method field select *VPI* and then tap *Ok*.
5. Select the *Element*, enter the required information and then tap *Store*. For details on supported elements, see the following:

Point elements

Circular arc elements

Symmetric parabola elements

Asymmetric parabola elements

6. When you have entered the last element, tap *Accept*.

Tip - To delete an element, highlight it and tap *Delete*. When you add an element, it appears below the previous element that you added. To insert it at a particular place in the list, highlight the element that you want it to follow. Tap *New* and enter details of the element.

7. Enter the other road components or tap *Store* to store the road definition.

Point elements

If you select *Point* in the *Element* field, use the *Station* and *Elevation* fields to key in values that define the VPI. The *Slope in* field updates to display the calculated slope value. The *Slope out* field updates when the next element is added.

Note - A vertical alignment defined by VPIs must end with a point.

Circular arc elements

If you select *Circular arc* in the *Element* field, use the *Station* and *Elevation* fields to key in values that define the VPI. Enter the radius of the circular arc in the *Radius* field. The *Slope in* field updates

to display the calculated slope value. The *Length*, *K factor* and *Slope out* fields update when the next element is added.

Symmetric parabola elements

If you select *Sym parabola* in the *Element* field, use the *Station* and *Elevation* fields to key in values that define the VPI and a length for the parabola. The *Slope in* field updates to display the calculated slope value. The *K factor* and *Slope out* fields update when the next element is added.

Asymmetric parabola elements

If you select *Asymmetric parabola* in the *Element* field, use the *Station* and *Elevation* fields to key in values that define the VPI. Enter the In and Out lengths of the parabola. The *Slope in* field updates to display the calculated slope value. The *K factor* and *Slope out* fields update when the next element is added.

Note - When you edit an element, only the selected element is updated. All adjoining elements remain unchanged.

Tip - To confirm the entry, use the *Slope in*, *Slope out*, *K factor* and *Sag / Summit* values.

Entry by start and end points

To add a vertical alignment to a new road definition by entering Start and end points, select *Vertical alignment* and then follow these steps:

1. To enter the first element that defines the alignment, tap *New*.
2. In the *Station* and *Elevation* fields, key in the values that define the first vertical point of intersection. The *Element* field is set to *Start point*. You cannot change this.
3. Tap *Store* to add the vertical element record.
4. Tap *New*. In the entry method field select *Start and End points* and then tap *Ok*.
5. Select the *Element*, enter the required information and then tap *Store*. For details on supported elements, see the following:

Point elements

Circular arc elements

Symmetric parabola elements

6. When you have entered the last element, tap *Accept*.

Tip - To delete an element, highlight it and tap *Delete*. When you add an element, it appears below the previous element that you added. To insert it at a particular place in the list, highlight the element that you want it to follow. Tap *New* and enter details of the element.

7. Enter the other road components or tap *Store* to store the road definition.

Point elements

If you select *Point* in the *Element* field, use the *Station* and *Elevation* fields to key in values that define the start point. The *Slope in* field updates to display the calculated slope value. The *Slope out* field updates when the next element is added.

Circular arc elements

If you select *Circular arc* in the *Element* field, use the *Start station*, *Start elevation*, *End station*, *End elevation*, and *Radius* fields to key in values that define the circular arc. The *Length*, *Slope in*, and *Slope out* fields update to display the calculated values.

Symmetric parabola elements

If you select *Sym parabola* in the *Element* field, use the *Start station*, *Start elevation*, *End station*, *End elevation*, and *K factor* fields to key in values that define the parabola. The *Length*, *Slope in*, and *Slope out* fields update to display the calculated values.

Note - When you edit an element, only the selected element is updated. All adjoining elements remain unchanged.

Tip - To confirm the entry, use the *Slope in*, *Slope out*, *K factor* and *Sag / Summit* values.

Template Positioning

Define the position of templates in a road definition by specifying the station at which the Trimble Survey Controller software starts to apply each template. A template is applied at the start station and template element values are then interpolated linearly (applied on a pro rata basis) from that point to the station where the next template is applied.

To define the template positioning:

1. Select *Template positioning*.
2. Tap *New*.
3. In the *Start station* field, specify the start station for the template(s).
4. Select the templates to apply. The options in the drop-down list for the *Left template* and *Right template* fields are as follows:
 - ◆ <None> - no template is assigned. Use this option to create a gap in the road definition.
 - ◆ <Interpolate> - the template for this station is interpolated from the previous and next templates in the road definition.
 - ◆ Templates - defined using the *Key in / Templates* option.
6. Tap *Store* to apply the templates.
7. Tap *New* to enter more templates at other positions.
8. When all template positions are entered tap *Accept*.

Tip - To delete a highlighted entry, tap *Delete*.

9. Enter the other road components or tap *Store* to store the road definition.

For more information, see the [example alignment](#) with the associated table. That topic shows how the template assignments, including the templates "None" and "Interpolate", can be used to achieve the required road definition.

Roding Template - Example Alignment

The following discussion explains how positioning of templates and use of system templates can be used to control a Trimble road definition. See the plan in the following figure.

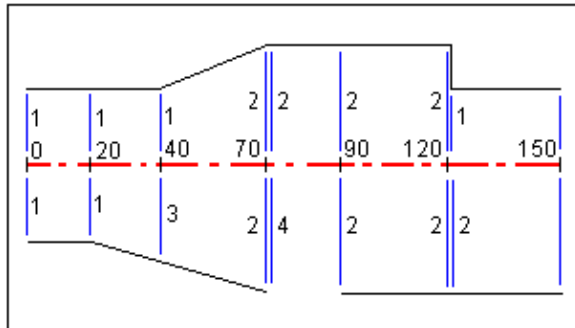

Right side of the road

On the right side, template 1 is assigned to stations 0 and 20. The road transitions from template 1 at station 20 to template 2 at station 70. Because a template must be assigned at station 40 on the left side, the system template <Interpolate> 3 must be assigned to the right side of the road to maintain correct interpolation. To correctly represent the gap between stations 70 and 90, the system template <None> 4 is assigned at a nominal distance after station 70 (5 mm). To complete the right side of the road, template 2 is assigned to stations 90, 120, and 120.005.

Left side of the road

On the left side, template 1 is assigned to stations 0, 20, and 40. The road transitions from template 1 at station 40 to template 2 at station 70. To correctly represent the design, template 1 is assigned a nominal distance after station 120 (5 mm).

Assign the templates at the specified start stations as shown in the following table:

Start station	Left templates	Right templates
0.000	Template 1	Template 1
20.000	Template 1	Template 1
40.000	Template 1	<Interpolate> 3

70.000	Template 2	Template 2
70.005	Template 2	<None> 4
90.000	Template 2	Template 2
120.000	Template 2	Template 2
120.005	Template 1	Template 2

Cross section Interpolation

The two methods of interpolating between cross sections are:

- by elevation
- by cross slope

To specify the interpolation method

1. Select *Files / Properties of current job* and then select *Cogo settings*.
2. From the *Road cross section interpolation by field*, select *Elevation* or *Cross slope*.
3. Tap *Accept*.

Interpolation by elevation

See the following figure where the template at station 100 includes a first element with an end elevation of 10.0. The next template is assigned at station 400 and has a first element with an end elevation of 7.0. The cross section for stations 200 and 300 are interpolated as shown to provide even grading of elevation from station 100 to 400.

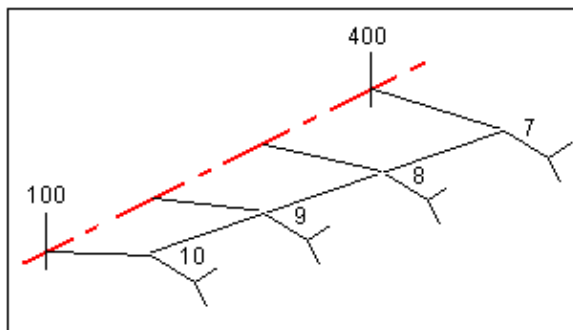

Interpolation by cross slope

See the following figure where the template at station 100 includes a first element with a crossfall of -2%. The next template is assigned at station 400 and has a first element with a crossfall of -5%. The cross section for stations 200 and 300 are interpolated as shown to provide even grading of cross slope from station 100 to 400.

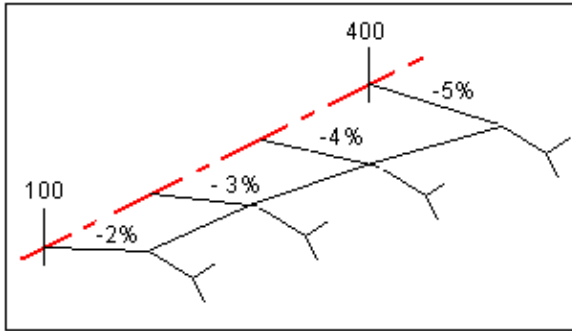

Interpolating between templates that have a different number of design elements

For templates with an unequal number of design line elements, the template with the least elements has zero length elements added before the side slope element. The interpolation is then performed given an equal number of elements exist. See the figure below, where a zero length element 3 has automatically been inserted.

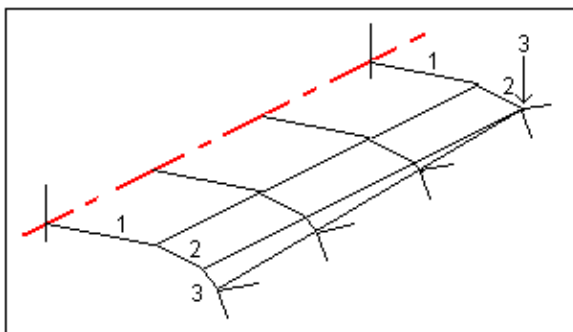

By adding zero length template elements, you can further control the interpolation process to best represent the road design.

Notes

- If the design requires a gap in its definition use the None templates.
- No interpolation occurs between a null and a valid template.
- Templates are interpolated after superelevation and widening have been applied.

Interpolation of side slopes

If consecutive templates contain side slopes of differing values intermediate stations have side slopes interpolated based on the slope value as a percentage.

For example, if the side slope value at station 600 is 50% (1:2) and at station 800 it is 16.67% (1:6) the side slope value at station 700 will be $50\% + 16.7\% / 2 = 33.33\%$ (1:3).

Superelevation and Widening

Define where superelevation and widening values are applied in a road definition by specifying the station at which the Trimble Survey Controller software starts to apply them. Superelevation and widening values are applied at the start station, and values are then interpolated linearly (applied on a pro rata basis) from that point to the station where the next superelevation and widening values are applied.

To add superelevation and widening values to a new road definition:

1. Select *Superelevation & widening* and tap *New*.
2. In the *Start station* field, specify the station where the superelevation and widening starts.
3. In the *Left super* and *Right super* fields, enter superelevation values for the left and right sides of the horizontal alignment.

Tip - To change the way a superelevation value is expressed, tap *Options* and change the *Grade* field as required.

4. In the *Pivot* field, specify the position about which the template rotates. The options are *Pivot left*, *Pivot crown*, and *Pivot right*.

Notes

- ◆ For *Pivot left* the pivot position is the maximum offset, left of the centerline, of the last template element with superelevation applied.
- ◆ For *Pivot crown* the pivot position is at the centerline.
- ◆ For *Pivot right* the pivot position is the maximum offset, right of the centerline, of the last template element with superelevation applied.

5. In the *Left widening* field, enter the widening value to be applied.

This value is applied to each element in the template that has the *Widening* check box selected.

6. Do the same for the *Right widening* field. Tap *Store* to add these superelevation and widening values to the road definition.

Note - Widening is expressed as a positive value.

7. To enter more superelevation and widening records tap *New*.
8. After entering the last superelevation and widening record, tap *Accept*.

Tip - To delete an entry, highlight it and tap *Delete*.

9. Enter the other road components, or tap *Store* to store the road definition.

Templates

To define a template for a new road definition, select *Templates* and then do the following:

1. Tap *New*, enter a template name and then tap *OK*.
To edit an existing template, highlight the template name, tap *Edit*, select the element to edit from the graphical template view and then tap *Edit* again.

Tip - Use the *Copy* option to copy an existing template definition into the current template.

3. Tap *New* to enter the first element defining the template.
4. Select an option from the *Element* field and enter the required information. For more information, see the appropriate section below.

Crossfall and offset

Delta elevation and offset

Side slope

5. To add the template element, tap *Store*. The element is added, and appears in the graphical template view. When you add an element, it appears after the previous element that you added. To insert it at a particular place, highlight the element in the graphical view that you want it to follow. Tap *New* and then enter details for the element.

Tip - To delete an element, highlight it and tap *Delete*.

6. To enter more elements that define this template, tap *New*.
6. When you have entered the last element, tap *Accept*.
7. To save the template, tap *Accept*.

Tip - To rename a template, highlight it and then tap *Rename*. To delete a template, tap *Delete*.

Crossfall and offset

If you selected *Crossfall and Offset* in the *Element* field:

1. In the *Crossfall* and *Offset* fields, enter the values that define the element.

Tip - To change the way a crossfall value is expressed, tap *Options* and change the *Grade* field as required.

2. Enter a value in the *Code* field (this step is optional).

Tip - The annotation entered in the *Code* field is assigned to the end of the element and is displayed during stakeout.

3. Select the *Apply superelevation* and *Apply widening* check boxes as required.

Note - The *Apply widening* check box is only available after the *Apply superelevation* check box has been selected.

Delta elevation and offset

If you selected *Delta elevation and Offset* in the *Element* field:

1. In the *Delta elevation* and *Offset* fields, enter the values that define the element.
2. Enter a value in the *Code* field (this step is optional).

Tip - The annotation entered in the *Code* field is assigned to the end of the element and is displayed during stakeout.

3. Select the *Apply superelevation* and *Apply widening* check boxes as required.

Note - The *Apply widening* check box is only available after the the *Apply superelevation* check box has been selected.

Side slope

If you selected *Side Slope* in the *Element* field:

1. In the *Cut slope* (1), *Fill slope* (2), and *Cut ditch width* (3) fields, enter the values that define the element.

Note - Cut and fill slopes are expressed as positive values.

The following diagram shows the side slope.

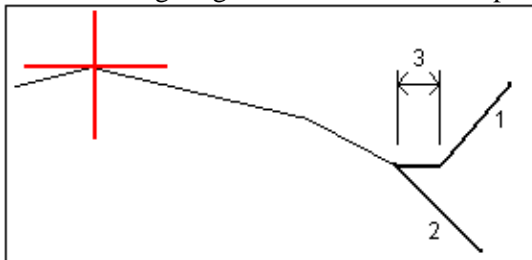

2. Enter a value in the *Code* field (this step is optional).

Tip - The annotation entered in the *Code* field is assigned to the end of the element and is displayed during stakeout.

Station equations

Use *Station equations* to define the station values for an alignment.

To define an equation:

1. Select *Station equations*.
2. Tap *New*.
3. In the *Back station* field, enter a station value.
4. In the *Ahead station* field, enter a station value. The *True station* value will be calculated.
5. Tap *Store*.

The values entered in the *Back station* and *Ahead station* fields are shown: The zone is indicated by a number after the colon in each field. The calculated *Progression*, indicating whether the station value increases or decreases after the station equation, is also shown.

Note - The zone up to the first station equation is zone 1.

Tip - To change the progression for the last station equation, tap *Edit*.

6. To add further equations, tap *New*. To delete an equation, tap *Delete*. To accept the entered equations, tap *Accept*.

Group strings

To define a new group from a GENIO file:

1. Select a GENIO file from the list. Tap *Edit*.
2. Do one of the following:
 - ◆ To define a new group, tap *New*.
 - ◆ To edit an existing group, highlight the GENIO file name and then tap *Edit*.
3. Enter a group name and then tap *OK*.
4. Define the group.

To define the group:

1. From the graphics window, tap strings to select them. Alternatively, drag a box outline to select multiple strings. Selected master strings are shown as solid red circles. Selected sub strings are shown as solid blue circles. Tap a selected string to deselect it.
2. To clear your current selection or to undo your last selection, tap and hold in the graphics window and then select the appropriate option from the pop-up menu.
3. To select strings from a list of string names, tap and hold in the graphics window and then select *List selection* from the pop-up menu. Tap the string names you want to select. Selected strings appear in the list with a check mark next to them. To clear your current selection, tap *Clear*.
4. Tap *Accept*.

Tip - Tap *Rename* to rename an existing group.

Notes

- A group can include only one master string (6D). If the GENIO file does not include a 6D string but does include a 12D string, then the Trimble Survey Controller software will generate a 6D string with the same geometry as the 12D string and positions every 5 meters / feet.
- Because the station values for 3D and 5D strings are defined relative to the selected 6D string, select strings for the group that obviously define a road.
- Where available, Trimble recommends that you include the 12D string that is coincident with the selected master string in the group. 12D strings include the geometry for the vertical alignment that enables the Trimble Survey Controller software to correctly interpolate elevations between positions along the master string.
- Unselected master and geometry strings appear as open red circles. Unselected sub strings (3D and 5D) appear as open dark gray circles.
- Tap and hold on a string to browse the string name.
- To define a new 3D string, tap and hold in the graphics view and then select *New string* from the pop-up menu. This option is not available until you have selected a master (6D) string.

New string

Use this function to [define](#) a new string, [edit](#) a string you have defined, or [delete](#) a string.

Defining a new string

1. From the *Group strings* option, create a new group or edit an existing group.
2. Tap and hold in the graphics screen and then select *New string* from the pop-up menu.
3. Enter a string name.
4. Select the string that the new string will be derived from.
5. Select a string derivation method and then enter values that define the new string.

The following figure illustrates the *Offset and calculated slope* method where the *Derived from* string (1), the *Offset* value (2) and the *Calculated from* string (3) define a new string (4) on the slope between the *Derived from* and *Calculated from* strings.

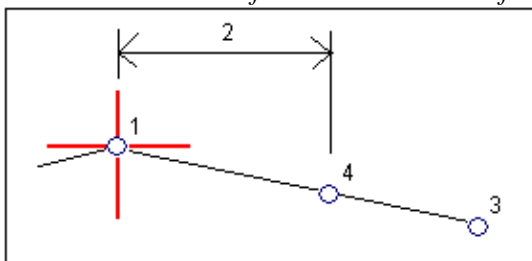

6. Tap *Accept*.

Notes

- When you define a new group, you must select a master (6D) string before the *New string* menu option is available.

- New string names must consist of four alphanumeric characters.
- New strings are created as 3D strings.
- You cannot define a new string relative to a 5D string.
- New strings are colored teal.

Editing a new string



1. From the *Group strings* field, select *Edit* and then select the group containing the string to edit.
2. Tap and hold in the graphics screen and select *Edit string* from the pop-up menu.
3. Select the string to edit. You can only edit strings that have been defined using the *New* string functionality and that belong to the current group.
4. Edit the details as required.
5. Tap *Accept*.

Deleting a string

1. From the *Group strings* field select *Edit* and then select the group containing the string to delete.
2. Tap and hold in the graphics screen and then select *Delete string* from the pop-up menu.
3. Select the string to delete. You can only delete strings that have been defined using the *New* string function and that belong to the current group.
4. Tap *OK*.

Key in - Notes

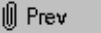
You can enter a note in the Trimble Survey Controller database at any time. To do this:

1. To access the *Key in note* screen, do one of the following:
 - ◆ From the main menu, select *Key in / Notes*.
 - ◆ Tap *Favorites / Key in note*.
 - ◆ On the controller keyboard, press **CTRL + N**.
2. Type in the details to be recorded. Alternatively tap *T/Stamp* to generate a record of the current time.
3. To store the note do one of the following:
 - ◆ Tap *Store* to store the note in the database.
 - ◆ Tap  *Prev* to attach the note to the previous observation.
 - ◆ Tap  *Next* to attach the note to the next observation to be stored.

Note - When you use  *Next*, the note is only stored with the next observation if another observation is stored during the current survey. If the survey is ended without storing another observation the note is discarded.

4. To exit *Key in notes*, tap *Esc*. Alternatively, if the *Note* form is empty, tap *Store*.

Note - If a feature code list is already selected for the job, you can use codes from the list when keying in a note. From the *Note* screen, press Space to display the feature code list. Select a code from the list or type the first few letters of the code.

In *Review*, tap *Note* to add a note to the current record.

In *Point manager*, scroll to the right and tap in the *Note* field to add a note to the point record.

Tunnel: Key in

Use this option to key in and edit a tunnel.

Note - The key in tunnel functionality is only available if you have the Trimble Survey Controller Engineering option (PN 90100-02, 90100-03) enabled on your controller.

To key in a Tunnel:

1. From the main menu, select *Key in / Tunnels*.
2. Tap *New* and then enter a name for the tunnel definition.
To edit an existing tunnel, highlight the tunnel name and then tap *Edit*.

Tip - Use the *Copy* option to copy an existing tunnel definition with all its components into the current tunnel.

3. Choose a component to key in:

Horizontal Alignment

Vertical Alignment

Template Positioning

Templates

To review a keyed in tunnel tap the *Review* softkey. You can tap the icon at the bottom right corner of the screen to view the cross sections and then use the up and down arrows to view the cross section at other stations.

Notes

- The Trimble Survey Controller software treats all tunnel distances, including stationing and offset values, as grid distances. The value in the *Distances* field (*Files / Properties of current job - Cogo settings*), has no effect on the tunnel definition or the way tunnel distances are displayed.
- If a ground coordinate system is defined in either the Trimble Geomatics or Trimble Survey Controller software, then the grid coordinates are, in effect, also ground coordinates.
- Keyed in tunnels are saved to the current project folder as 'tunnel name'.txt. Tunnels are available for all jobs in the current project folder.

To use a file saved to the current project folder in another project, use Windows Explorer to copy or move the file to the appropriate project folder.

Tunnel: Horizontal Alignment

To add a horizontal alignment to a tunnel definition, select *Horizontal alignment*. You can enter the alignment using one of the following methods:

- ◆ **Length**
- ◆ **End station**
- ◆ **End coordinates**

Tunnel: Entry by Length

To add a horizontal alignment to a tunnel definition by entering the lengths of the elements, select *Horizontal alignment* and then do the following:

1. Tap *New* to enter the first element that defines the alignment. The *Element* field is set to *Start point*. You cannot change this.
2. Enter the *Start station*.
3. In the *Method* field, choose one of the following options:
 - ◆ *Key in coordinates*
 - ◆ *Select point*

If you choose the *Key in coordinates* method, enter values in the *Start north* and *Start east* fields. If you choose the *Select point* method field, enter a value in the *Point name* field. The *Start north* and *Start east* fields will update with the values for the entered point.

Tip - To edit the *Start north* and *Start east* values when they have been derived from a point, change the method to *Key in coordinates*.

4. Enter the *Station interval*. To add the horizontal element, tap *Store*.
5. To enter the next horizontal element tap *New*. In the *Entry Method* field select *Length*, and then tap *Ok*.
6. Select the *Element* method, enter the required information, and then tap *Store*.
7. To enter further elements, see the following:

Line elements

Arc elements

Entry spiral/Exit spiral elements

8. When you have entered the last element, tap *Accept*.

Tip - To delete an element, highlight it and tap *Delete*. When you add an element, it appears below the previous element that you added. To insert it at a particular place in the list, highlight the element that you want it to follow. Tap *New* and enter details of the element.

9. Enter the other tunnel components, or tap *Store* to store the tunnel definition.

Tip - Tap *Method* to change the entry method to *End station*.

Line elements

If you select *Line* in the *Element* field, the *Start station* field displays the start station value for the line that you are defining. You cannot edit this.

In the *Azimuth* and *Length* fields, enter values that define the line. The *End North* and *End East* fields update to display the coordinates at the end of the element just added.

If this line is not the first line to be defined, the *Azimuth* field displays an azimuth calculated from the previous element. To edit the azimuth, select *Edit azimuth* from the pop-up menu in the *Azimuth* field. The software indicates that the element is non tangential by coloring the element icon red.

Tip - To reload the original azimuth select *Restore tangency* from the pop-up menu.

Arc elements

If you select *Arc* in the *Element* field, the *Start station* field displays the start station value for the arc that you are defining. You cannot edit this.

The following table shows the available methods and the fields that appear when you select each one.

Method	Procedure
Radius and length	Specify arc direction. In the <i>Radius</i> and <i>Length</i> fields, enter values that define the arc.
Delta angle and radius	Specify arc direction. In the <i>Angle</i> and <i>Radius</i> fields, enter values that define the arc.
Deflection angle and length	Specify arc direction. In the <i>Angle</i> and <i>Length</i> fields, enter values that define the arc.

The *End North* and *End East* fields update to display the coordinates at the end of the element just added.

The *Azimuth* field displays the azimuth as calculated from the previous element. To edit the azimuth, select *Edit azimuth* from the pop-up menu in the *Azimuth* field. The software indicates that the element is non tangential by coloring the element icon red.

Tip - To reload the original azimuth select *Restore tangency* from the pop-up menu.

Entry spiral/Exit spiral elements

If you select *Entry spiral/Exit spiral* in the *Element* field, the *Start station* field displays the start station value for the entry spiral or exit spiral that you are defining. You cannot edit this.

Specify the arc direction. In the *Start radius*, *End radius* and *Length* fields, enter values that define the spiral.

The *End North* and *End East* fields update to display the coordinates at the end of the element just added.

The *Azimuth* field displays the azimuth as calculated from the previous element. To edit the azimuth, select *Edit azimuth* from the pop-up menu in the *Azimuth* field. The software indicates that the element is non tangential by coloring the element icon red.

Tip - To reload the original azimuth select *Restore tangency* from the pop-up menu.

Note - Spirals are defined as Clothoids.

Tunnel: Entry by End station

To add a horizontal alignment to a tunnel definition by entering end station values, select *Horizontal alignment* and then do the following:

1. Tap *New* to enter the first element that defines the alignment. The *Element* field is set to *Start point*. You cannot change this.
2. Enter the *Start station*.
3. In the *Method* field, choose one of the following options:
 - ◆ *Key in coordinates*
 - ◆ *Select point*

If you choose the *Key in coordinates* method, enter values in the *Start north* and *Start east* fields. If you choose the *Select point* method field, enter a value in the *Point name* field. The *Start north* and *Start east* fields will update with the values for the entered point.

Tip - To edit the *Start north* and *Start east* values when they have been derived from a point, change the method to *Key in coordinates*.

4. Enter the *Station interval*. To add the horizontal element, tap *Store*.
5. To enter the next horizontal element, tap *New*. In the *Entry Method* field select *End station* and then tap *Ok*.
6. Select the *Element* method, enter the required information, and then tap *Store*.
7. To enter further elements, see the following:

Line elements

Arc elements

Entry spiral/Exit spiral elements

8. When you have entered the last element, tap *Accept*.

Tip - To delete an element, highlight it and tap *Delete*. When you add an element, it appears below the previous element that you added. To insert it at a particular place in the list, highlight the element that you want it to follow. Tap *New* and enter details of the element.

9. Enter the other tunnel components, or tap *Store* to store the tunnel definition.

Tip - Tap *Method* to change the entry method to *Length*.

Line elements

If you select *Line* in the *Element* field, the *Start station* field displays the start station value for the line that you are defining. You cannot edit this.

In the *Azimuth* and *End station* fields, enter values that define the line. The *End North* and *End East* fields update to display the coordinates at the end of the element just added.

If this line is not the first line to be defined, the *Azimuth* field displays an azimuth calculated from the previous element. To edit the azimuth, select *Edit azimuth* from the pop-up menu in the *Azimuth* field. The software indicates that the element is non tangential by coloring the element icon red.

Tip - To reload the original azimuth select *Restore tangency* from the pop-up menu.

Arc elements

If you select *Arc* in the *Element* field, the *Start station* field displays the start station value for the arc that you are defining. You cannot edit this.

The following table shows the available methods and the fields that appear when you select each one.

Method	Procedure
Radius and end station	Specify arc direction. In the <i>Radius</i> and <i>End station</i> fields, enter values that define the arc.
Deflection angle and end station	Specify arc direction. In the <i>Angle</i> and <i>End station</i> fields, enter values that define the arc.

The *End North* and *End East* fields update to display the coordinates at the end of the element just added.

The *Azimuth* field displays the azimuth as calculated from the previous element. To edit the azimuth, select *Edit azimuth* from the pop-up menu in the *Azimuth* field. The software indicates that the element is non tangential by coloring the element icon red.

Tip - To reload the original azimuth select *Restore tangency* from the pop-up menu.

Entry spiral/Exit spiral elements

If you select *Entry spiral/Exit spiral* in the *Element* field, the *Start station* field displays the start station value for the entry spiral or exit spiral that you are defining. You cannot edit this.

Specify arc direction. In the *Start radius*, *End radius* and *End station* fields, enter values that define the spiral.

The *End North* and *End East* fields update to display the coordinates at the end of the element just added.

The *Azimuth* field displays the azimuth as calculated from the previous element. To edit the azimuth, select *Edit azimuth* from the pop-up menu in the *Azimuth* field. The software indicates that the element is non tangential by coloring the element icon red.

Tip - To reload the original azimuth select *Restore tangency* from the pop-up menu.

Note - Spirals are defined as Clothoids.

Tunnel: Entry by End coordinates

To add a horizontal alignment to a tunnel definition by entering end coordinates or points, select *Horizontal alignment* and then do the following:

1. Tap *New* to enter the first element that defines the alignment. The *Element* field is set to *Start point*. You cannot change this.
2. Enter the *Start station*.
3. In the *Method* field, choose one of the following options:
 - ◆ *Key in coordinates*
 - ◆ *Select point*

If you choose the *Key in coordinates* method, enter values in the *Start north* and *Start east* fields. If you choose the *Select point* method field, enter a value in the *Point name* field. The *Start north* and *Start east* fields will update with the values for the entered point.

Tip - To edit the *Start north* and *Start east* values when they have been derived from a point, change the method to *Key in coordinates*.

4. Enter the *Station interval*. To add the horizontal element, tap *Store*.
5. To enter the next horizontal element tap *New*. In the *Entry method* field select *End coordinates* and then tap *Ok*.
6. Select the *Element* method, enter the required information, and then tap *Store*.
7. To enter further elements, see the following:

Line elements

Arc elements

8. When you have entered the last element, tap *Accept*.

Tip - To delete an element, highlight it and tap *Delete*. When you add an element, it appears below the previous element that you added. To insert it at a particular place in the list, highlight the element that you want it to follow. Tap *New* and enter details of the element.

9. Enter the other tunnel components, or tap *Store* to store the tunnel definition.

Line elements

If you select *Line* in the *Element* field , the *Start station* field displays the start station value for the line that you are defining. You cannot edit this.

In the *Method* field, choose one of the following options:

- *End coordinates*
- *Select end point*

If you choose the *End coordinates* method, enter values in the *End north* and *End east* fields. The *Azimuth* and *Length* fields will update with the values for the entered coordinates.

If you choose the *Select end point* method field , enter a value in the *Point name* field. The *Azimuth* and *Length* fields and the *End north* and *End east* fields will update with the values for the entered point.

Tip - To edit the *End north* and *End east* values when they have been derived from a point, change the method to *End coordinates*.

Arc elements

If you select *Arc* in the *Element* field, the *Start station* field displays the start station value for the arc that you are defining. You cannot edit this.

In the *Method* field, choose one of the following options:

- *End coordinates*
- *Select end point*

If you choose the *End coordinates* method, enter values in the *End north* and *End east* fields. The *Azimuth*, *Arc direction*, *Radius* and *Length* fields will update will update with the values for the entered coordinates.

If you choose the *Select end point* method field , enter a value in the *Point name* field. The *Azimuth*, *Arc direction*, *Radius* and *Length* fields and the *End north* and *End east* fields will update with the values for the entered point.

Tip - To edit the *End north* and *End east* values when they have been derived from a point, change the method to *End coordinates*.

Tunnel: Vertical Alignment

To add a vertical alignment to a tunnel definition, select *Vertical alignment*. You can enter the alignment using one of the following methods:

- **Vertical Points of Intersection**
- **Start and end points**

Note - The selected entry method applies to all elements defining the vertical alignment.

Tunnel: Entry by Vertical Points of Intersection (VPI)

To add a vertical alignment to a tunnel definition by entering Vertical Points of Intersection (VPI), select *Vertical alignment* and then do the following:

1. To enter the first element that defines the alignment, tap *New*.
2. In the *Station* and *Elevation* fields, key in the values that define the first vertical point of intersection. The *Element* field is set to *Start point*. You cannot change this.
3. Tap *Store* to add the vertical element record.
4. Tap *New*. In the entry method field select *VPI* and then tap *Ok*.
5. Select the *Element* method, enter the required information, and then tap *Store*.
6. To enter further elements, see the following:

Point elements

Circular arc elements

Symmetric parabola elements

Asymmetric parabola elements

7. When you have entered the last element, tap *Accept*.

Tip - To delete an element, highlight it and tap *Delete*. When you add an element, it appears below the previous element that you added. To insert it at a particular place in the list, highlight the element that you want it to follow. Tap *New* and enter details of the element.

8. Enter the other tunnel components, or tap *Store* to store the tunnel definition.

Point elements

If you select *Point* in the *Element* field, use the *Station* and *Elevation* fields to key in values that define the VPI. The *Slope in* field updates to display the calculated slope value. The *Slope out* field updates when the next element is added.

Note - A vertical alignment defined by VPIs must end with a point.

Circular arc elements

If you select *Circular arc* in the *Element* field, use the *Station* and *Elevation* fields to key in values that define the VPI. Enter the radius of the circular arc in the *Radius* field. The *Slope in* field updates to display the calculated slope value. The *Length*, *K factor* and *Slope out* fields update when the next element is added.

Symmetric parabola elements

If you select *Sym parabola* in the *Element* field, use the *Station* and *Elevation* fields to key in values

that define the VPI and a length for the parabola. The *Slope in* field updates to display the calculated slope value. The *K factor* and *Slope out* fields update when the next element is added.

Asymmetric parabola elements

If you select *Asymmetric parabola* in the *Element* field, use the *Station* and *Elevation* fields to key in values that define the VPI. Enter the In and Out lengths of the parabola. The *Slope in* field updates to display the calculated slope value. The *K factor* and *Slope out* fields update when the next element is added.

Note - When you edit an element, only the selected element is updated. All adjoining elements remain unchanged.

Tip - To confirm the entry, use the *Slope in*, *Slope out*, and *K factor* values.

Tunnel: Entry by Start and End Points

To add a vertical alignment to a tunnel definition by entering Start and end points, select *Vertical alignment* and then do the following:

1. To enter the first element that defines the alignment, tap *New*.
2. In the *Station* and *Elevation* fields, key in the values that define the first vertical point of intersection. The *Element* field is set to *Start point*. You cannot change this.
3. Tap *Store* to add the vertical element record.
4. Tap *New*. In the entry method field select *Start and End points* and then tap *Ok*.
5. Select the *Element*, enter the required information and then tap *Store*. For details on supported elements, see the following:

Point elements

Circular arc elements

Symmetric parabola elements

6. When you have entered the last element, tap *Accept*.

Tip - To delete an element, highlight it and tap *Delete*. When you add an element, it appears below the previous element that you added. To insert it at a particular place in the list, highlight the element that you want it to follow. Tap *New* and enter details of the element.

7. Enter the other tunnel components, or tap *Store* to store the tunnel definition.

Point elements

If you select *Point* in the *Element* field, use the *Station* and *Elevation* fields to key in values that define the start point. The *Slope in* field updates to display the calculated slope value. The *Slope out*

field updates when the next element is added.

Circular arc elements

If you select *Circular arc* in the *Element* field, use the *Start station*, *Start elevation*, *End station*, *End elevation*, and *Radius* fields to key in values that define the circular arc. The *Length*, *Slope in*, and *Slope out* fields update to display the calculated values.

Symmetric parabola elements

If you select *Sym parabola* in the *Element* field, use the *Start station*, *Start elevation*, *End station*, *End elevation*, and *K factor* fields to key in values that define the parabola. The *Length*, *Slope in*, and *Slope out* fields update to display the calculated values.

Note - When you edit an element, only the selected element is updated. All adjoining elements remain unchanged.

Tip - To confirm the entry, use the *Slope in*, *Slope out*, and *Length* values.

Tunnel: Template Positioning

To define the position of templates in a tunnel definition, specify the station at which the Trimble Survey Controller software starts to apply each template. A template is applied at the start station, and template element values are then interpolated linearly (applied on a pro rata basis) from that point to the station where the next template is applied.

Note - For interpolation to take place between templates they must have the same number of elements.

To define the template positioning:

1. Select *Template positioning*.
2. Tap *New*.
3. In the *Start station* field, specify the start station for the template(s).
4. Select the template to apply.
6. Tap *Store* to apply the template.
7. Tap *New* to enter more templates at other positions.
8. When all template positions are entered tap *Accept*.

Tip - To delete a highlighted entry, tap *Delete*.

9. Enter the other tunnel components, or tap *Store* to store the tunnel definition.

Note - Tap the *Options* softkey to specify if the templates are applied *Vertical* or *Perpendicular* to the vertical alignment. See the following diagram where the red linework indicates the template applied perpendicular and the blue linework a template applied vertically.

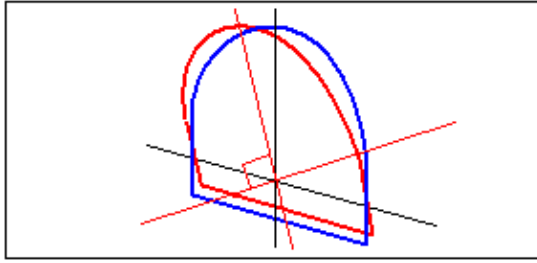

Tunnel: Templates

To define a template for a tunnel definition, select *Templates* and then do the following:

1. Tap *New*, enter a template name and then tap *OK*.

Tip - Use the *Copy* option to copy an existing template definition into the current template.

2. To edit an existing template highlight the template name and tap *Edit*. Then, from the graphical template view select the element and then tap *Edit*.
3. Tap *New* to enter the start point element defining the template.
4. In the *Horizontal offset* and *Vertical offset* fields, enter the values that define the *Start point* and then tap *Store*. The element appears in the graphical view.
5. To enter further elements, tap *New*, select the *Element* and *Method* and then enter the required information. For details on supported elements and entry methods, see the following:

Line elements

Arc elements

6. When you have entered the last element, tap *Accept*.

Tip - To delete an element, highlight it and tap *Delete*. When you add an element, it is added after the last element that you added. To insert it at a particular place, highlight the element in the graphical view that you want it to follow. Tap *New* and then enter details for the element.

Note - Templates can be open or closed.

7. Enter the other tunnel components, or tap *Store* to store the tunnel definition.

Tip - To rename a template, highlight it and then tap *Rename*. To delete a template, highlight it and then tap *Delete*.

Line elements

To add a line to the template definition, select *Line* in the *Element* field.

The following table shows the available methods and the fields that appear when you select each one.

Method	Procedure
Cross fall and offset	In the <i>Cross fall</i> and <i>Offset</i> fields, enter values that define the line. To change the way a cross fall value is expressed, tap <i>Options</i> and then change the <i>Grade</i> field as required.
Delta elevation and offset	In the <i>Delta elevation</i> and <i>Offset</i> fields, enter values that define the line.
End point	In the <i>Horizontal offset</i> and <i>Vertical offset</i> fields, enter values that define the end point of the line.

For all methods, you can specify a *Code*.

Arc elements

To add an arc to the template definition, select *Arc* in the *Element* field.

The following table shows the available methods and the fields that appear when you select each one.

Method	Procedure
End point and Radius	In the <i>Horizontal offset</i> and <i>Vertical offset</i> fields, enter values that define the end point of the arc. Enter the <i>Radius</i> . Select <i>Large arc</i> , if required.
Alignment and Delta angle	Specify the <i>Delta angle</i> for the arc. The center point for the arc is defined by the horizontal and vertical alignments.
Center point and delta angle	In the <i>Horizontal offset</i> and <i>Vertical offset</i> fields, enter values that define the center point of the arc. Enter the <i>Delta angle</i> for the arc.

Tip - On page two the parameters defining the arc are displayed.

For all methods, you can specify a *Code*.

Cogo

Cogo Menu

For some calculations, you must define a projection, or select a Scale factor-only coordinate system.

You can display ellipsoid, grid, or ground distances by changing the *Distances* field in the [Cogo settings](#) screen.

To perform Cogo calculations in a *No projection / No datum* coordinate system, set the *Distances* field to *Grid*. The Trimble Survey Controller software then performs standard Cartesian computations. If the grid distances you enter are distances on the ground, the new computed grid coordinates will be ground coordinates.

Note - When the *Distances* field is set to *Ground* or *Ellipsoid*, the Trimble Survey Controller software attempts to perform calculations on the ellipsoid. Because there is no relationship established at this point, the system cannot compute coordinates.

For more information, see:

[Compute Inverse](#)

[Compute Point](#)

[Compute Area](#)

[Compute Azimuth](#)

[Compute Distance](#)

[Compute Average](#)

[Subdivide a Line](#)

[Subdivide an Arc](#)

[Taped distances](#)

[Traverse](#)

[Calculator](#)

Cogo - Compute Inverse

To calculate the azimuth, horizontal, vertical, and slope distances between two existing points:

1. From the map, select the From point (1) and To point (2), as shown in the diagram below.
2. Tap and hold on the map and select *Compute inverse* from the shortcut menu. Alternatively, select *Cogo / Compute inverse* from the main menu.
3. The azimuth (3), horizontal distance (4), change in elevation, slope distance and grade are shown.

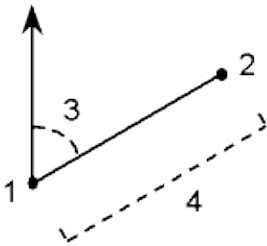

Cogo - Compute Point

Use this Cogo function to calculate the coordinates of an intersection point from 1 or 2 existing points. You can store the results in the database.

Use *Options* to specify ground, grid, or sea level distances.

Note - When entering an existing point name you can select from the list, perform a fast fix or measure a point. Fast fix stores an automatic rapid point with a temporary point name.

Warning - In general, do not compute points and then change the coordinate system or perform a calibration. If you do, these points will be inconsistent with the new coordinate system. An exception to this is points computed using the *Brng-dist from a point* method.

Note - If you use the *Four point intersection* method or the *From a baseline* method and then change the antenna height record for one of the source points, the coordinates of the point will not be updated.

Note - If the measured points were measured using GPS, the coordinates of the point can only be displayed as grid values if a projection and a datum transformation are defined.

Note - For all methods when the point is stored use the *Store as* field to specify if the calculated point is to be stored as WGS84, Local or Grid coordinates values.

Note - You can compute an azimuth from two points in the database directly in an azimuth field. To do this, enter the point names in the *Azimuth* field, separated by a hyphen. For example, to compute the azimuth from point 2 to point 3, enter "2-3". This method works with most alphanumeric point names, but it does not support point names that already contain a hyphen.

Calculate coordinates using one of the following methods:

Brng-dist from a point

Turned angle and distance

Brng-dist intersect

Brng-brng intersect

Dist-dist intersect

Four point intersection

From a baseline

Vertical plane and angle

Brng-dist from a point

To calculate the coordinates of an intersection using the Brng-dist from a point method:

1. From the main menu, select *Cogo / Compute point*.
2. Enter a *Point name*.
3. In the *Method* field, select Bearing and distance.
4. In the *Start point* field, use the advanced pop-up arrow () to select either a Radial or Sequential measurement method. When *Sequential* is selected the *Start point* field is automatically updated to the last stored intersection point (see diagrams below).
5. Set the *Azimuth origin* to either Grid 0°, True, Magnetic, or Sun (GPS only).
6. As shown in the diagrams below, enter the name of the Start point (1), the azimuth (2) and the horizontal distance (3).
7. Tap *Calc* to calculate the intersection point (4).
8. Store the point in the database.

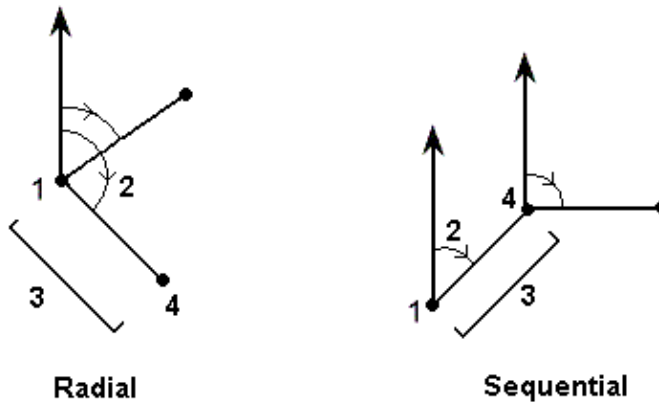



To compute the misclosure of a loop of points:

1. Give the last point the same name as the first start point.
2. Tap *Calc* for the point coordinates.

When you tap *Store*, the loop misclosure appears on the screen. Store the last point as a check to avoid overwriting the first point.

Turned angle and distance

To calculate the coordinates of an intersection using the turned angle and distance method:

1. From the main menu, select *Cogo / Compute point*.
2. Enter a *Point name*.
3. In the *Method* field, select Turned angle and distance.
4. In the *Start point* field, tap the advanced pop-up arrow (), then select either a *Radial* or *Sequential* measurement method. When *Sequential* is selected, the Start point name automatically updates to the last stored intersection point (see diagrams below).
5. In the *End point* field, tap the advanced pop-up arrow (), then select either an *Azimuth* or *End point* to define a reference orientation.
When using the sequential method, the reference orientation for new points moving forward is the computed reverse azimuth from the previous turned angle.
6. As shown in the diagrams below, enter the name of the Start point (1), the azimuth (2) and the horizontal distance (3).
7. Tap *Calc* to calculate the intersection point (4).
8. Store the point in the database.

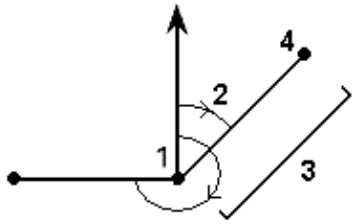

Radial

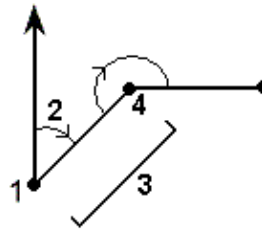

Sequential

Brng-dist intersect

To calculate the coordinates of an intersection using the Brng-dist intersect method:

1. From the main menu, select *Cogo / Compute point*.
2. Enter a *Point name*.
3. In the *Method* field, select Brng-dist intersection.
4. As shown in the diagram below, enter the name of Point 1 (1), the azimuth (2), the name of Point 2 (3) and the horizontal distance (4).
5. Tap *Calc*.
6. There are two solutions (5,6) for this calculation; tap *Other* to see the second solution.
7. Store the point in the database.

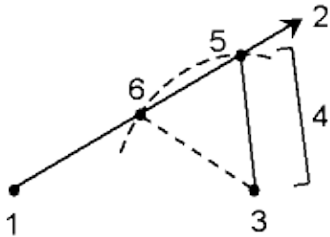

Brng-brng intersect

To calculate the coordinates of an intersection using the Brng-brng intersect method:

1. From the main menu, select *Cogo / Compute point*.
2. Enter a *Point name*.
3. In the *Method* field, select Brng-brng intersect.
4. As shown in the diagram below, enter the name of Point 1 (1), the azimuth from point one (2), the name of Point 2 (3), and the azimuth from point two (4).
5. Tap *Calc* to calculate the intersection point (5).

6. Store the point in the database

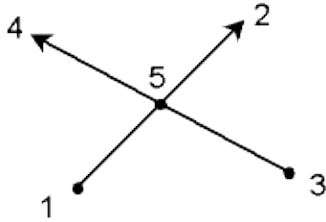

Dist-dist intersect

To calculate the coordinates of an intersection using the Dist-dist intersect method:

1. From the main menu, select *Cogo / Compute point*.
2. Enter a *Point name*.
3. In the *Method* field, select Dist-dist intersect.
4. As shown in the diagram below, enter the name of Point 1 (1), the horizontal distance (2), the name of Point 2 (3) and the horizontal distance (4).
5. Tap *Calc*.
6. There are two solutions (5,6) for this calculation; tap *Other* to see the second solution.
7. Store the point in the database.

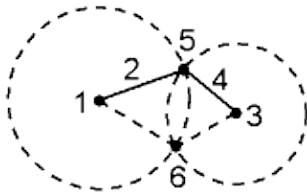

To record an offset using the Four point intersection method:

1. From the main menu, select *Cogo / Compute point*.
2. Enter a *Point name*.
3. In the *Method* field, select Four point intersection.
4. As shown in the diagram below, enter the names of the start point of line 1 (1), the end point of line 1 (2), the start point of line 2 (3) and the end point of line 2 (4).
5. Enter any change in the vertical position as a vertical distance from the end of line 2.
6. To calculate the offset point (5), tap *Calc*.

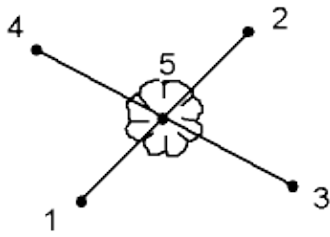

Note - The two lines do not have to intersect, but they must converge at some point, as shown below.

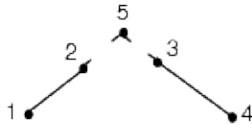

To record an offset using the From a baseline method:

1. From the main menu, select *Cogo / Compute point*.
2. Enter a *Point name*.
3. In the *Method* field, select From a baseline.
4. As shown in the diagram below, enter the names of the start point (1) and the end point (2) of the baseline.
5. Enter a *Distance* and select the *Distance direction* method (5, 6, 7, or 8).
6. Enter the offset distance and select the *Offset direction* (3 or 4).
7. Enter the vertical distance from the end of the line.

Note - Enter a positive offset if the point is offset to the right (4) of the end point, or a negative offset if it is to the left (3). Enter 0 for either the distance or the offset if you do not want the point offset in that direction.

8. To calculate the offset point (9), tap *Calc*.

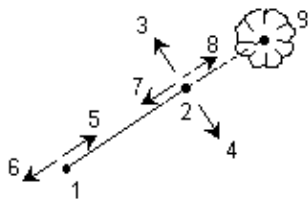

To calculate the coordinates of a point using the Vertical plane and angle method:

1. From the main menu, select *Cogo / Compute point*.
2. Enter a *Point name*.
3. In the *Method* field, select Vertical plane and angle.
4. As shown in the diagram below, enter the names of the points (1) and (2) that define the vertical plane, for example, the side of a building. Name and measure new points, or enter the names of existing points.

5. Tap *Meas HA VA* to measure the angle from the instrument (3) to the required point (4).
The intersection of the vertical plane and the measured angle is used to calculate coordinates for the required point.
6. Tap *Store* to store the point in the database.

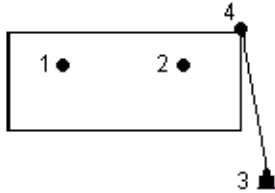

Cogo - Compute Area

To calculate an area enclosed by points in the database:

1. From the map, select the points on the perimeter of the area to be calculated. Use the order that they occur on the perimeter.
2. Tap and hold on the map and select *Compute area* from the shortcut menu.

Alternatively, select *Cogo / Compute area* from the main menu.

Note - The computed area varies according to the [Distance](#) display setting.

The diagram below shows the calculated area (1) and perimeter (2).

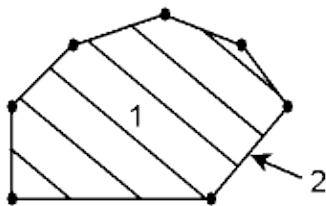

Cogo - Compute Azimuth

You can use keyed-in data, and points stored in the database, to calculate an azimuth by various methods. You can also store the results in the database. For some methods, you have to tap *Calc* to display the results.

The data that you enter can have different units. For example, you can add an angle in degrees to an angle in radians-the answer is returned in whatever format you specified in the job configuration.

Calculate an azimuth using one of the following methods:

[Between two points](#)

[Bisected azimuths](#)

[Bisected corner](#)

[Azimuth plus angle](#)

[Azimuth to line offset](#)

Between two points

To calculate the azimuth between two points:

1. From the main menu, select *Cogo / Compute azimuth*.
2. In the *Method* field, select *Between two points*.
3. As shown in the diagram below, enter the name of the From point (1) and the To point (2).
4. The azimuth between them (3) is calculated.

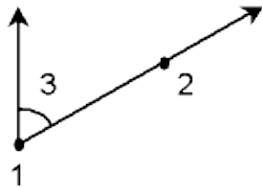

Note - You can compute an azimuth from two points in the database directly in an azimuth field. To do this, enter the point names in the *Azimuth* field, separated by a hyphen. For example, to compute the azimuth from point 2 to point 3, enter "2-3". This method works with most alphanumeric point names, but it does not support point names that already contain a hyphen.

Bisected azimuths

To calculate bisected azimuths:

1. From the main menu, select *Cogo / Compute azimuth*.
2. In the *Method* field, select *Bisected azimuths*.
3. As shown in the diagram below, enter values for *Azimuth 1* (1), and *Azimuth 2* (2).
4. The azimuth halfway between them (3), is calculated.

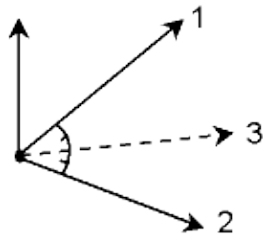

Bisected corner

To calculate a bisected corner azimuth:

1. From the main menu, select *Cogo / Compute azimuth*.
2. In the *Method* field, select Bisected corner.
3. As shown in the diagram below, enter the names of the *Side point 1* (1), the *Corner point* (2), and *Side point 2* (3).
4. The azimuth (4), halfway between Side point 1 and Side point 2, from the Corner point, is calculated.

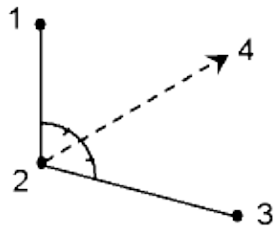

Azimuth plus angle

To calculate the azimuth plus angle:

1. From the main menu, select *Cogo / Compute azimuth*.
2. In the *Method* field, select Azimuth plus angle.
3. As shown in the diagram below, enter the *Azimuth* (1) and the *Turned angle* (2).
4. The sum of the two (3) is calculated.

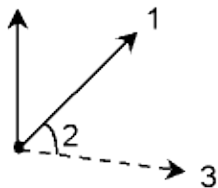

Azimuth to line offset

To calculate the azimuth to line offset:

1. From the main menu, select *Cogo / Compute azimuth*.
2. In the *Method* field, select *Azimuth to line offset*.
3. As shown in the diagram below, enter the name of the line (1), the stationing (2) and the horizontal offset (3).

Tip - If the line does not already exist, tap the advanced pop-up arrow and then select *Two points*. You can then enter the start point and end point to define the line.

4. The azimuth (4), from the start point of the line to the offset point is calculated.

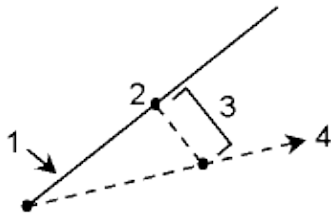

Cogo - Compute Distance

You can use keyed-in data, and points stored in the database, to calculate a distance by various methods. You can also store the results in the database.

The data that you enter can have different units. For example, if you add a distance in meters to a distance in feet, the answer is returned in whatever format you specified in the job configuration.

For some methods you have to tap *Calc* to display the results.

[Between two points](#)

[Between point and line](#)

[Between point and arc](#)

Between two points

To compute the distance between two points:

1. From the main menu, select *Cogo / Compute distance*.
2. In the *Method* field, select *Between two points*.
3. Enter the *From point* and the *To point*.
4. The distance between the two points is calculated.

Between point and line

To compute the distance between a point and a line:

1. From the main menu, select *Cogo / Compute distance*.
2. In the *Method* field, select *Between point and line*.
3. As shown in the diagram below, enter the *Point name* (1) and the *Line name* (2).

Tip - If the line does not already exist, tap the advanced pop-up arrow and select *Two points*. You can then enter the start point and end point to define the line.

4. The distance along the line (3) and the perpendicular distance (4) to the line is calculated. The distance along the line is from the point specified (5).

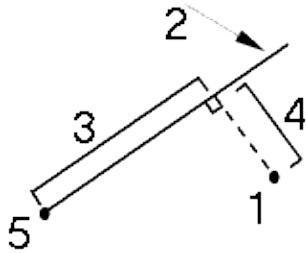

Between point and arc

To compute the distance between a point and an arc:

1. From the main menu, select *Cogo / Compute distance*.
2. In the *Method* field, select *Between point and arc*.
3. As shown in the diagram below, enter the *Point name* (1) and the *Arc name* (2).
4. The distance along the arc (3) and the perpendicular distance (4) to the arc is calculated. The distance along the arc is from the point specified (5).



Cogo - Compute Average

Use the *Compute average* option to compute and store the average position for a point that has been measured more than once.

Enter the name of the point to compute the average position for into the *Point name* field. You can select the point name from a list using the [pop-up menu](#) for the field.

If the point you entered has only one position fix, or has been stored as a control point, then an error message appears to tell you that an average position cannot be computed.

Once you enter a point name for which an average position can be computed, Trimble Survey Controller searches the database to find all the positions for that point. Once computed, the average point grid position appears, along with the standard deviations for each ordinate.

Note - Any Mean Turned Angle (MTA) observed to the point is ignored and the original observations are used to compute the average position.

If there are more than two positions for the point, a *Details* softkey appears. Tap *Details* to view the residuals from the average position to each individual position. You can use this residuals form to include or exclude specific positions from the average computation.

Tip - Trimble Survey Controller averages all positions in the current job database with the same name (except Control points). Tap *Details* to ensure that only the required positions are averaged.

To store the computed average position for the point, tap *Store*. If an averaged position for the point already exists in the database, the existing point is automatically deleted when the new average position is stored.

The averaged position is stored as a grid position. An averaged position is not automatically updated if the positions used to compute the average are changed, for example, if the calibration is updated, if observations are transformed or deleted, or if new observations of the same name are added. If this occurs, you should re-compute the averaged position.

Cogo - Subdivide a line

Use this function to subdivide a line into segments. The points created are automatically stored in the database and the point names are automatically incremented from the Start point name.

You can predefine the code of a subdivided point. For more information, see [Subdivide Pts Code](#).

Subdivide a line using one of the following methods:

[Fixed segment length](#)

[Fixed number of segments](#)

Tip - If the line does not already exist, tap the advanced pop-up arrow and then select *Two points*. You can then enter the start point and end point to define the line.

Fixed segment length

To subdivide a line into segments of fixed length:

1. Do one of the following:
 - ◆ From the map, select the line to be subdivided (1). Tap and hold on the screen and then select the *Subdivide a line* option from the shortcut menu.
 - ◆ From the main menu, select *Cogo / Subdivide a line*. Enter the name of the defined line.
2. In the *Method* field, select Fixed segment length.
3. Enter the segment length (2), and any horizontal offset (3) and vertical offset from the line.
4. Enter the names of the *Start at station* (4), the *End at station* (5), and the *Start point name*.
5. Tap *Start* to calculate the new points (4, 6, 7, or 8, 9, 10).

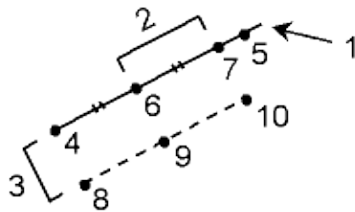

Fixed number of segments

To subdivide a line into a fixed number of segments:

1. Do one of the following:
 - ◆ From the map, select the line to be subdivided. Tap and hold on the screen and then select the *Subdivide a line* option from the shortcut menu.
 - ◆ From the main menu, select *Cogo / Subdivide a line*. Enter the name of the defined line.
1. In the *Method* field, select Fixed number of segments.
2. Enter the number of segments, and any horizontal offset (2) and vertical offset from the line.
3. Enter the names of the *Start at station* (3), the *End at station* (4), and the *Start point name*.
4. Tap *Start* to calculate the new points (3, 5, 4, or 6, 7, 8).

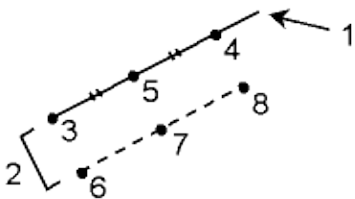

Cogo - Subdivide an arc

Use this function to subdivide an arc using one of the following methods:

[Fixed segment length](#)

Fixed number of segments

Fixed chord length

Fixed angle subtended

The points created are automatically stored in the database and the point names are incremented from the Start point name.

You can predefine the code of a subdivided point. For more information, see [Subdivide Pts Code](#).

Fixed segment length

To subdivide an arc into segments of fixed length:

1. Do one of the following:
 - ◆ From the map, select the arc to be subdivided. Tap and hold on the screen and select the *Subdivide an arc* option from the shortcut menu.
 - ◆ From the main menu, select *Cogo / Subdivide an arc* . Enter the name of the defined arc.
2. In the *Method* field, select Fixed number of segments.
3. Enter the segment length (2), and any horizontal offset (3) and vertical offset from the arc.
4. Enter the names of the *Start at station* (4), the *End at station* (5), and the *Start point name*.
5. Tap *Start* to calculate the new points (4, 6, 7, or 8, 9, 10).

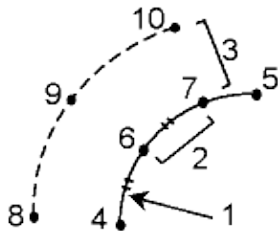

Fixed number of segments

To subdivide an arc into a fixed number of segments:

1. Do one of the following:
 - ◆ From the map, select the arc to be subdivided. Tap and hold on the screen and select the *Subdivide an arc* option from the shortcut menu.
 - ◆ From the main menu, select *Cogo / Subdivide an arc* . Enter the name of the defined arc.
2. In the *Method* field, select Fixed number of segments.
3. Enter the number of segments, and any horizontal offset (2) and vertical offset from the arc.
4. Enter the names of the *Start at station* (3), the *End at station* (4), and the *Start point name*.
5. Tap *Start* to calculate the new points (3, 5, 4, or 6, 7, 8).

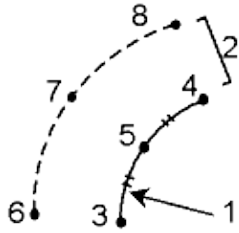

Fixed chord length

To subdivide an arc into segments of fixed chord length:

1. Do one of the following:
 - ◆ From the map, select the arc to be subdivided. Tap and hold on the screen and select the *Subdivide an arc* option from the shortcut menu.
 - ◆ From the main menu, select *Cogo / Subdivide an arc* . Enter the name of the defined arc.
2. In the *Method* field, select Fixed chord length.
3. Enter the chord length (2), and any horizontal offset (3) and vertical offset from the arc.
4. Enter the names of the *Start at station* (4), the *End at station* (5), and the *Start point name*.
5. Tap *Start* to calculate the new points (4, 6, 7, or 8, 9, 10).

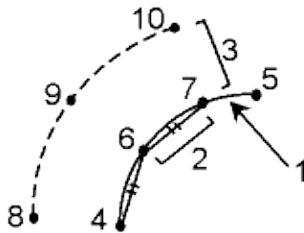

Fixed angle subtended

To subdivide an arc into fixed angle subtended segments:

1. Do one of the following:
 - ◆ From the map, select the arc to be subdivided. Tap and hold on the screen and select the *Subdivide an arc* option from the shortcut menu.
 - ◆ From the main menu, select *Cogo / Subdivide an arc*. Enter the name of the defined arc.
2. In the *Method* field, select Fixed angle subtended.
3. Enter the *Angle subtended* (2), and any horizontal offset (3) and vertical offset from the arc.
4. Enter the names of the *Start at station* (4), the *End at station* (5), and the *Start point name*.
5. Tap *Start* to calculate the new points (4, 6, 7, or 8, 9, 10).

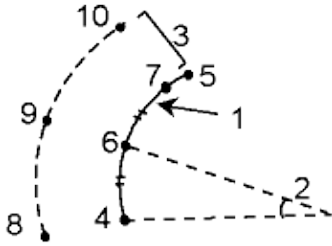

Taped distances

Use this function to add points to your Trimble Survey Controller job. Use a graphical right angle and distance interface to define rectangular structures, such as a building or building foundations. Key in or measure two points to define the first side, orientation, and location of the object.

Tip - To select the elevation from the Start point or End point, use the pop-up menu in the *Elevation* field.

To select the direction for your next point graphically on the plan view, tap the screen or use the right and left arrow keys. The dashed red line shows the current direction for the next side. To create the next side, tap *Add*, and then enter the distance to the next point using the angle defined in the plan view.

Alternatively, select a point that already exists in your job and the software will calculate the distance to that point for you.

To measure a point using GPS or Conventional, select *Fastfix* or *Measure* from the pop-up menu on the *Point name* field.

Tip - If your style is configured for a laser rangefinder, Laser is available in the pop-up menu for *Length* and *H. Dist* fields. Tap *Laser* to measure distances using the laser.

To close the object back onto the start point, tap *Close*. A horizontal distance will be computed and displayed. Use this as a check against your plan or your taped distance. To complete the function, tap *Store*. To add further sides to the object, tap *Add*.

Tip - If you need more detailed information on the quality of the close, use a different point name for the end point, and store the object. Then compute an inverse between the start point and the end point.

To change a keyed in distance before the feature is stored, tap *Edit*, and then select the end point of the side to edit. When you adjust the distance, the plan view updates. You can then continue to add more sides.

Notes

- Once the feature has been stored, you can no longer edit the lengths of the sides.
- The orientation is defined by the first side. Only parallel or 90° angles can be added from this side. To use a different angle, store the object, and then create a new side.
- Because new points are stored as polars, taped distances will not work without a Scale factor only or fully defined Projection in the coordinate system.
- In addition to the new points that are created, lines are created automatically and stored to the Trimble Survey Controller database. These are visible in the map and can be used to stake out lines.

Cogo - Transformations

Use this Cogo function to transform a single point, or a selection of points, using one or a combination of Rotation, Scale, and Translations. When performing more than one translation, the order is always Rotation, Scale, then Translation.

Rotate

To rotate a selection of points about a specified origin point:

1. From the main menu, select *Cogo / Transformations*.
2. Set the *Rotate* check box, then tap *Next*.
3. Enter an *Origin point*.
4. Enter a *Rotation*.
5. Tap *Next* and then select the point(s) to rotate.
6. To store the transformed point(s) to the database, tap *Accept*.

A transformation deletes the original point(s) and stores new grid points of the same name.

Scale

To scale the distances between the origin point and the selected points:

1. From the main menu, select *Cogo / Transformations*.
2. Set the *Scale* check box, then tap *Next*.
3. Enter an *Origin point*.
4. Enter a *Scale factor*.
5. Tap *Next*, then select the point(s) to scale.
6. To store the transformed point(s) to the database, tap *Accept*.

A transformation deletes the original point(s) and stores new grid points of the same name.

Translate

To move a selection of points on a grid surface:

1. From the main menu, select *Cogo / Transformations*.
2. Set the *Translate* check box, then tap *Next*.
3. In the *Method* field, select either *Deltas* or *Two points*.

If you choose *Deltas*:

1. Enter a delta Northing, Easting, and/or Elevation. You can select a single delta, for example a Northing, or any combination of deltas for the transformation.

If you choose *Two points*:

1. Select a *From point*.

2. Select a *To point*.
4. Tap *Next*, then select the point(s) to transform.
5. To store the transformed point(s) to the database, tap *Accept*.

A transformation deletes the original point(s) and stores new grid points of the same name.

Notes

- Only points that can be displayed as grid coordinates can be transformed.
- When transforming by both rotate and scale, the origin for the scale defaults to the origin for the rotate. You can change this.
- When entering a point name, you can select from the list, key in a point, perform a fast fix, measure a point, or make a map selection. Fast fix stores an automatic rapid point with a temporary point name.

Warning - If you select a base point to be transformed, then vectors flowing from this base become null.

Cogo - Traverse

Use this function to calculate a traverse misclosure, and adjust a conventional traverse. The software helps you select the points to be used, calculates the misclosure, and then lets you compute either a Compass or Transit adjustment.

Note - The Compass adjustment is sometimes known as the Bowditch adjustment.

You can calculate closed-loop traverses and closed traverses that start and end on pairs of known points.

To calculate a traverse:

1. Enter the *Traverse name*.
2. In the *Start station* field, tap *List*.
3. Select a point from the list of valid traverse points that can be used as the start station. Tap *Enter*.

A valid start station has one or more backsights and one or more observations to the next traverse station.

4. Tap *Add* to add the next point in the traverse.
5. Select the next station in the traverse.

A valid traverse station has one or more backsight observations to the previous traverse station, and one or more observations to the next traverse station. When there is only one valid traverse station, it is added automatically.

Note - To view the observed azimuth and distance between two points in the list, highlight the first point and tap the Info softkey.

6. Repeat steps 4 and 5 until all points in the traverse have been added.

A valid end station has one or more backsights, and one or more observations to the previous traverse station.

If you need to remove any points from the list, highlight the point and tap *Delete*. When you delete a point, all points after it are deleted as well.

7. Tap *Close* to compute the traverse misclosure.

Note - You cannot add more points after selecting a control point, or a station with more than one backsight.

Note - To compute a traverse closure, there must be at least one distance measurement between successive points in the traverse list.

Note - The *Azimuth* fields do not have to be completed.

If the backsight azimuth is null:

- ◆ the traverse cannot be oriented.
- ◆ adjusted coordinates cannot be stored.
- ◆ an angular adjustment cannot be computed on an open traverse. (A distance adjustment can be computed.)

If the foresight azimuth is null in a loop traverse, and if all angles have been observed, you can compute an angular and distance adjustment.

The backsight and foresight points that provide the orientation for the traverse are shown.

If necessary, tap *Enter* to edit the fields as follows:

1. Inspect the results of the traverse and do one of the following:
 - ◆ To store the closure results, tap *Store*.
 - ◆ To adjust the traverse, go to the next step.
2. Tap *Options* to check the traverse settings. Make any changes as required, then tap *Enter*.
3. Tap *Adj. Ang.* to adjust the angular misclosure. The angular misclosure is distributed according to the setting in the *Options* screen.
4. Inspect the results of the traverse, then do one of the following:
 - ◆ To store the angular adjustment details, tap *Store*.
 - ◆ To adjust the distance misclosure, tap *Adj. dist.* The distance misclosure is distributed according to the setting in the *Options* screen and the traverse is stored.

When the traverse is stored, each point used in the traverse is stored as an adjusted traverse point with a search classification of adjusted. If there are any previously adjusted traverse points of the same name, they are deleted.

Pop-Up Menu Controls

To insert a feature name into a field, enter the name or tap the pop-up menu button  and select one of the following options from the list that appears:

List	select features from the database
Key in	key in details
Measure	measure a point
Fast fix	automatically measure a construction class point
Map selections	select from a list of the features currently selected in the map
Calculator	shortcut to the Calculator
Units	select units for the field

To change the method of data entry, tap the advanced pop-up menu button . The first two or three fields change.

Cogo Settings

Use this screen to configure the distance type (grid, ground, or ellipsoid), and the grid coordinate system orientation to be used by the Trimble Survey Controller software.

You can select a south azimuth, or set the grid coordinates to increase in north-east, south-west, north-west, or south-east directions.

For a GPS survey, specify an ellipsoid (in Datum transformation) if ground distances are to be displayed, otherwise the WGS-84 ellipsoid is used.

When you select *Scale factor only* in a conventional instrument only survey, grid and ground distances can be displayed.

To configure the Cogo settings, select *File / New job / Cogo settings* when creating a new job. For an existing job select *File / Properties of current job / Cogo settings*.

Distance Display

The *Distances* field defines how distances are displayed and which distances are used for calculations in the Trimble Survey Controller software. Select one of the following options:

- Ground (the default setting)
- Ellipsoid
- Grid

The following diagram shows the options between points A and B.

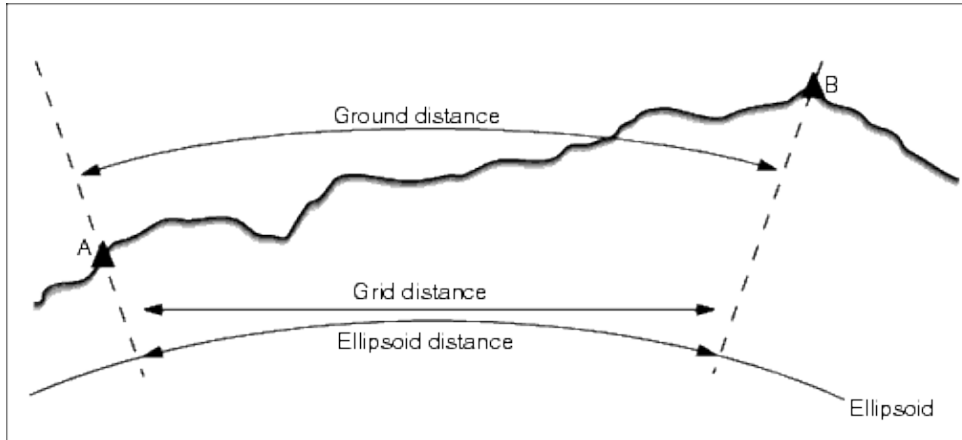

Ground distance

A ground distance is the horizontal distance calculated between the two points at the mean elevation parallel to the chosen ellipsoid.

If an ellipsoid has been defined in the job and the *Distances* field is set to *Ground*, the distance is calculated parallel to that. If no ellipsoid has been defined, the WGS84 ellipsoid is used.

Ellipsoid distance

If the *Distances* field is set to *Ellipsoid* then a correction is applied and all distances are calculated as if on the local ellipsoid, which usually approximates to sea level. If no ellipsoid has been specified, the WGS84 ellipsoid is used.

Note - If the coordinate system for a job is defined as *Scale factor only*, ellipsoid distances cannot be displayed.

Grid distance

If the *Distances* field is set to *Grid*, the grid distance between two points is displayed. This is the simple trigonometrical distance between the two sets of two-dimensional coordinates. If the coordinate system for the job is defined as *Scale factor only*, and the *Distances* field is set to *Grid*, the Trimble Survey Controller software displays ground distances multiplied by the scale factor.

Note - A grid distance between two measured GPS points cannot be displayed unless you have specified a datum transformation and a projection, or performed a site calibration.

Curvature Correction

In the Trimble Survey Controller system, all ellipsoid and ground distances are parallel to the ellipsoid.

Azimuth Display

The azimuth displayed and used by the Trimble Survey Controller software depends on the coordinate system

that you defined for the current job:

- If you defined both a datum transformation and a projection, or if you selected *Scale factor only*, the grid azimuth is displayed.
- If you defined no datum transformation and/or no projection, the best available azimuth is displayed. A grid azimuth is the first choice, then a local ellipsoidal azimuth, then the WGS84 ellipsoid azimuth.
- If you are using a laser rangefinder, the magnetic azimuth is displayed.

If a south azimuth display is required, set the *South azimuth* field to *Yes*. All azimuths still increase clockwise. The following diagram shows the effect of setting the *South azimuth* fields to No or Yes.

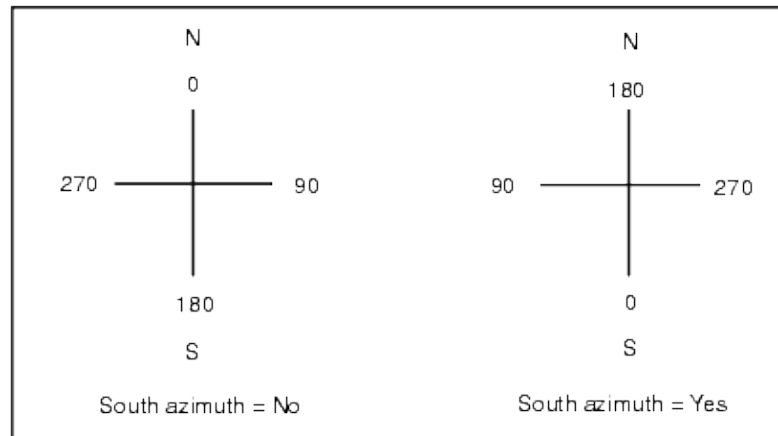

Grid Coordinates

Use the *Grid coords* field to set the grid coordinates to increase in one of the following sets of directions:

- north and east
- south and west
- north and west
- south and east

The following diagram shows the effect of each setting.

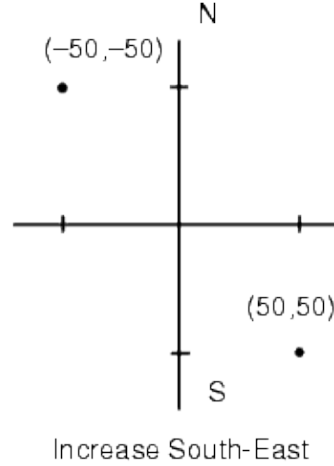
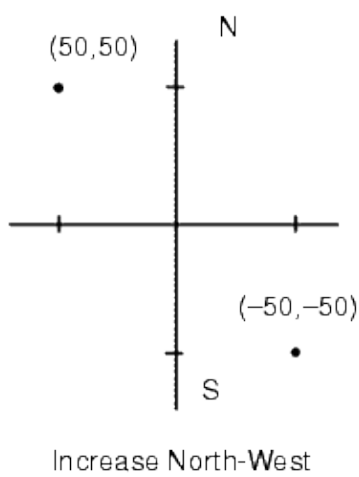
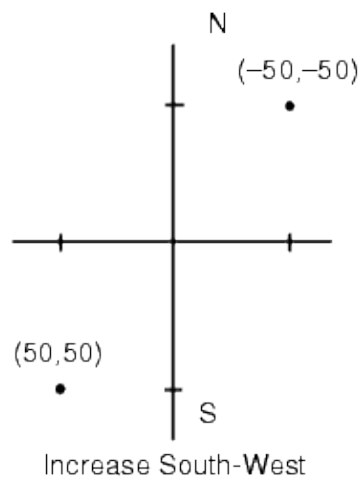
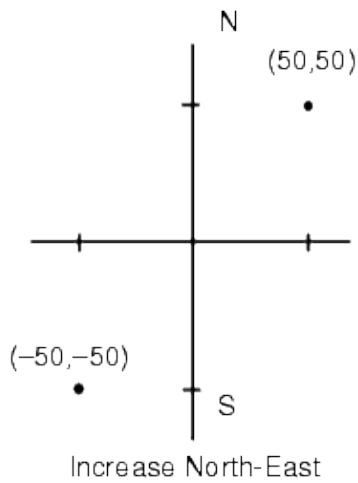

Magnetic Declination

Set the magnetic declination for the local area if magnetic bearings are being used in the Trimble Survey Controller software. You can use magnetic bearings if you choose the *Cogo / Compute* point using the *Brng-dist* from a point method.

The magnetic declination defines the relationship between magnetic north and grid north for the job. Enter a negative value if magnetic north is west of grid north. Enter a positive value if magnetic north is east of grid north. For example, if the compass needle points 7° to the east of grid north, the declination is $+7^\circ$ or 7°E .

Note - Use the published declination values if available.

Note - If grid north in the job has been rotated away from true north due to the coordinate system definition (possibly via a GPS calibration) then this must be allowed for in the magnetic declination specified.

Neighborhood adjustment

You can apply a *Neighborhood adjustment* to all conventional foresight observations made from a Station setup plus or Resection, and to all GPS observations made in a job that has a valid GPS site calibration. To apply Neighborhood adjustment, select the check box in *Properties of current job / Cogo settings*.

Neighborhood adjustment uses the residuals from *Station setup plus*, *Resection* or *GPS site calibration* to calculate delta grid values to apply to subsequent observations made during the survey. Each observation is adjusted according to its distance from each of the backsight points (for a conventional survey) or calibration points (for a GPS survey). The following formula is used to calculate the weight to give the residuals of each backsight or calibration point:

$$p = 1/D^n \text{ where:}$$

- p is the weight of the backsight or calibration point
- D is the distance to the backsight or calibration point
- n is the weight exponent

A weighted average is then computed and the resulting delta values are applied to each new observation to get an adjusted grid position.

Note - A high value for the weight exponent results in low impact (weight) of distant backsight or calibration points.

For *Neighborhood adjustment* to be applied, the station setup or calibration must have at least 3 known points with 2D grid residuals. That is, if you perform a:

- Station setup plus, you must have HA VA SD observations to at least 2 backsight points, each with known 2D coordinates.
- Resection, you must have HA VA SD observations to at least 3 backsight points, each with known 2D coordinates.
- Calibration, you must have GPS observations to at least 3 control points, each with known 2D coordinates.

Notes

- Neighborhood adjustment will use a *GPS site calibration* only if it has been observed in the current Trimble Survey Controller job. This is because a GPS calibration that is part of the coordinate system in an uploaded job does not include the GPS calibration residuals.
- For *Station setup plus*, the known station coordinate is included in the neighborhood adjustment calculation. In the calculation, the station coordinate is given grid residuals of zero.
- Neighborhood adjustment is a 2D-only adjustment. Any vertical residuals from station setup or calibration are not used in the neighborhood adjustment calculations.
- Neighborhood adjustment using GPS site calibration residuals is applied to all WGS84 points in the job, not just GPS observations.

Warning - Make sure that the backsight or calibration points are around the perimeter of the site. Do not survey outside the area enclosed by the backsight or calibration points (and for Station setup plus, the station point). The neighborhood adjustment is not valid beyond this perimeter.

Road cross section interpolation method

Two methods of interpolating between cross sections are supported:

- interpolation by elevation
- interpolation by cross slope

See [Roading template - Example alignment](#) for a description of the two methods.

Survey - General

Survey Menu

Use this menu to measure and stake out points using the [Survey Styles](#) defined in the Trimble Survey Controller software.

For more information, see:

[Integrated Surveys](#)

[Conventional Surveys](#)

[FastStatic Surveys](#)

[PPK Surveys](#)

[RTK Surveys](#)

[RTK and Infill Surveys](#)

Getting Started

All surveys in Trimble Survey Controller are controlled by a Survey Style. Survey Styles define the parameters for configuring and communicating with your instruments, and for measuring and storing points. This whole set of information is stored as a template and used each time you start a survey.

Configure the style only if the defaults do not suit your needs. To change the configuration of the Trimble Survey Controller software for different types of survey, select *Configuration / Survey Styles* from the main menu.

After this, whenever you want to use a particular survey style, you can select it from the [Survey menu](#).

Note - If there is only one survey style, it is automatically selected when you choose *Survey* from the main menu. Otherwise, select a style from the list that appears.

For details on how to set up these two types of surveys, see [Conventional Surveys](#), or [Real-Time Kinematic Surveys](#).

For details on how to set up an Integrated survey, see [Integrated_Surveys](#).

For more information on other types of GPS surveys, see [GPS Surveys](#).

Getting Connected

The Trimble Survey Controller software can automatically connect to Trimble GPS and conventional instruments.

To auto-connect to a Trimble instrument, the software cycles through a set of connection protocols for each type of instrument. It can take up to 15 seconds to complete the cycle, which means it can take up to 15 seconds to automatically connect to a Trimble instrument, depending on where the software is in the auto-connect cycle when the instrument is connected.

There are three main groups of Trimble instruments that can be automatically connected: *Trimble GPS receivers*, *Trimble VX/S Series total stations*, *Trimble 5600/3600 total stations*.

If you connect to only one of these types of instrument, you can speed up the automatic connection time by clearing the check box for the instrument type(s) you do not connect to.

To set the auto-connect options, tap the auto-connect icon in the status bar **before** you connect to an instrument.

When the software is trying to automatically connect to an instrument, the auto-connect icon flashes. There is a different icon for each type of instrument. For example, if you select only *Trimble GPS receivers*, then only the Trimble GPS receiver icon flashes.

If the auto-connect icon displays all three icons, and is not flashing, then auto-connect has been disabled for all three groups of instruments.

You do not have to wait for auto-connect to connect to your instrument. To force a connection, select the survey style and start the survey at any time.

To connect to a non-Trimble instrument, you must force a connection by starting the surveying.

Tip - When using non-Trimble instruments, disable auto-connect. Some commands used by auto-connect can interfere with the communication of non-Trimble instruments.

PIN lock security for Trimble VX Spatial Station and Trimble S8 Total Station

To enter a PIN that locks and unlocks the Trimble VX Spatial Station and Trimble S8 Total Station, use the Face 2 display.

When the instrument is locked, the controller cannot communicate with it, and the Trimble Survey Controller software will display the following message:

Instrument locked

The instrument is locked. Enter the PIN using the instrument Face 2 display. Once the PIN is accepted, tap OK below.

If the instrument is locked, and you forget your password, contact your local Trimble dealer for information on how to unlock the instrument.

Note - The PIN lock security support is available only when using instrument firmware version R10.0.58 or later.

Integrated Surveying

The Trimble Survey Controller software can switch between a GPS survey and a conventional survey, within the same job.

In an integrated survey, the controller is connected to both devices at the same time. This makes switching between instruments very quick.

For more information, see:

[Integrated Surveys](#)

GPS Surveys

Note - If there is only one survey style, it is automatically selected when you choose Survey from the main menu. Otherwise, select a style from the list that appears.

The Trimble Survey Controller software provides Survey Styles for the following GPS survey types:

[FastStatic](#)

[Postprocessed Kinematic](#)

[Real-Time Kinematic](#)

[Real-Time Kinematic and Infill](#)

To use one of the following survey types, you must create your own survey style.

[Real-Time Kinematic and Data Logging](#)

[Real-Time Differential Survey](#)

[Real-Time Differential and Data Logging](#)

For information on how to configure settings for GPS surveys, see the following topics:

[Start Base Receiver](#)

[Measure Points](#)

[Measure Codes](#)

[Continuous Topo Points](#)

[Swap Base Receiver](#)

[Stakeout](#)

[Initialization](#)

[Configuring the Survey Style for a Site Calibration](#)

Conventional Surveys

Note - If there is only one survey style, it is automatically selected when you choose *Survey* from the main menu. Otherwise, select a style from the list that appears.

The Trimble Survey Controller software provides a default style for use with a conventional instrument. Configure this type of survey when you create or edit a survey style, then follow these steps to carry out a conventional survey.

1. [Configure your survey style](#)
2. [Prepare for a robotic survey](#)
3. [Perform a station setup](#)
4. [Begin the survey](#)
5. [End the survey](#)

Configure your survey style

Trimble Survey Controller automatically connects to Trimble VX/S Series, 5600, and 3600 instruments. Configure the style only if the defaults do not suit your needs.

To configure a survey style:

1. From the main menu, select *Configuration / Survey styles / <Style name>*.
2. Select each of the options in turn, and set them to suit your equipment and survey preferences.
3. Once you configure all the settings, tap *Store* to save them, and then tap *Esc* to return to the main menu.

For more information, see:

[Instrument](#)

[Laser rangefinder](#)

[Duplicate point tolerance](#)

[Traverse options](#)

Prepare for a robotic survey

To prepare a Trimble VX/S Series or 5600 instrument for a robotic survey, the instrument must be turned on, leveled, with the correct radio settings, and if required, a search window defined.

If the instrument is level, has the correct radio settings, and you are using the autocentered search window, press the trigger button to turn on the instrument for a robotic survey.

To configure the Radio channel and Network ID on a Trimble VX/S Series instrument without using the Trimble Survey Controller software, select [Radio settings] on the instrument through the *Face 2* menu display.

For more information, refer to the documentation for your instrument.

Note - Trimble Survey Controller cannot communicate with the Trimble VX/S Series instrument when the onboard programs are in use. Once you finish using the instrument's onboard programs, select [Exit] from the [Setup] menu to return to the [Waiting for connection] menu.

The following section describes how to level the instrument, configure the radio settings, and set the search window on the instrument through the Trimble CU controller.

Preparing the Trimble VX/S Series instrument for a Robotic survey

1. With the Trimble CU attached to the Trimble VX/S Series instrument, press the trigger button to turn on the instrument and controller.
2. Start the Trimble Survey Controller software, level the instrument and then tap *Accept* in the leveling screen.
Tap *Esc* to exit the *Corrections* screen and the *Trimble Survey Controller Basic* screen if they appear.
3. From the Trimble Survey Controller main menu, select *Instrument / Radio settings*.
4. Set the *Radio channel* and *Network ID* and then tap *Accept*.
5. Do one of the following:
 - To set a search window:
 - a. From the main menu, select *Survey / Start Robotic*.
 - b. Select *Define now* and tap *OK*.
 - c. Aim the instrument to the Top left corner of the search window and tap *OK*.
 - d. Aim the instrument to the Bottom right corner of the search window and tap *OK*.
 - e. Tap *OK* to suspend the controller ready for robotic operation.
 - If you plan to use an [Autocentered search window](#), press the power key on the Trimble CU to suspend the controller.
You do not need to define the search window now.
6. Remove the controller from the instrument and attach it to the robotic holder.
7. Press the power key on the Trimble CU. The Trimble Survey Controller software auto-connects to the instrument radio and displays the leveling screen. If required, level the instrument and tap *Accept*.

You are now ready to perform a station setup.

Preparing the Trimble 5600 instrument for a Robotic survey

1. With the Trimble CU attached to the Trimble 5600 instrument, press the trigger button to turn on the instrument and controller.
2. Start the Trimble Survey Controller software, level the instrument and then tap *Accept* in the leveling screen.
Tap *Esc* to exit the *Corrections* screen and the *Trimble Survey Controller Basic* screen if they appear.
3. From the Trimble Survey Controller main menu, select *Instrument / Radio settings*.
4. Set the *Radio channel*, *Station address* and *Remote address* and then tap *Accept*.
5. Do one of the following:
 - To set a search window:
 - a. From the main menu, select *Survey / Start Robotic*.
 - b. Aim the instrument to the Top left corner of the search window and tap *OK*.
 - c. Aim the instrument to the Bottom right corner of the search window and tap *OK*.
 - d. Tap *OK* to suspend the controller ready for robotic operation.
 - If you plan to use an [Autocentered search window](#), press the power key on the Trimble CU to suspend the controller.
You do not need to define the search window now.
6. Remove the controller from the instrument and then attach the controller to the robotic holder:
 - a. Connect the Trimble CU to Port A on the remote radio using the Trimble CU holder or a 0.4 m, 4-pin Hirose cable.
 - b. Turn on the active target or connect it to Port B on the remote radio.
7. Press the power key on the Trimble CU. The Trimble Survey Controller software auto-connects to the instrument radio and displays the leveling screen. If required, level the instrument and then tap *Accept*.

You are now ready to perform a station setup.

Note - The 5600 is re-initialized to compensate for the earlier removal of the controller.

When the instrument is suspended ready for robotic operation, it switches off to conserve power. The internal radio remains switched on so that the rover radio can communicate with the instrument when you start the rover survey.

Note - The internal radio settings are set when the Trimble Survey Controller software connects to the instrument. The remote radio settings are set later when you start the rover survey.

For more information, see [Radio settings](#).

Perform a station setup

To get the most out of the Station setup routine, tap *Options* to configure *Station setup* to match the way that you prefer to work.

You can configure the default point names, default heights, default instrument coordinates, and the default azimuth. Default instrument coordinates and default azimuth are used only if the instrument point is not already coordinated, and an azimuth to the backsight cannot be computed.

The *Default point names* option determines the default values for the instrument and the backsight point name fields each time you perform a station setup:

- If you always use the same names for your instrument and backsight points, select *Last used*. Use this method if you always use the default instrument coordinates, or if you repeatedly set up on the same known point.
- If you are performing a traverse type survey, select *Traversing*. When you start a new station setup, by default, the instrument uses the first foresight point observed from the last station setup for the *Instrument point name*, and the instrument point name used in the last station setup for the *Backsight point name*.
- If you want to key in or select the instrument and backsight point names each time you perform a station setup, select *All null*.

Note - These are only default values. You should select the option that matches your normal workflow. You can override the default values for any particular station setup.

Note - Do not confuse the *Last used* option with the *Use last* survey menu option.

The *Last used* option applies to a new station setup. The last values are used even across different jobs.

The *Use last* menu option reinstates the last station setup. No new station setup is performed.

The *Default heights* option determines the default values for the instrument and the backsight point height fields each time you perform a station setup.

- If you always use the same heights for your instrument and backsight points, select *Last used*. This option is available only if you set the *Default point names* option to *Last used*.
- If you are using the Trimble traverse kit (so that the last measured foresight and instrument heights can be used as the new instrument and backsight heights), select *Move forward*. This option is available only if you set the *Default point names* option to *Traversing*.
- If you want to key in a new instrument and backsight height for each station setup, select *All null*.

If the instrument point does not exist, the default instrument coordinates are used. This is particularly useful if you work in a local coordinate system, and always set up your instrument on coordinate (0,0,0) or (1000N, 2000E, 100E), for example. If you leave the *Default instrument coordinates* set to null, you can key in coordinates for instrument points that do not exist when you perform a station setup.

If an azimuth cannot be computed between the instrument and backsight points, the *Default azimuth* is used.

Note - If you always set up your instrument on a known point, and use a known azimuth, then leave the *Default instrument coordinates* and *Default azimuth* fields set to null. This ensures that you do not accidentally use default values if you incorrectly enter the name of the instrument and/or the backsight point names.

The Trimble Survey Controller software normally expects you to measure a backsight point to orient your survey. If your survey practice does not require you to measure to the backsight, clear the *Measure backsight*

checkbox on the second page of options. The software automatically creates a virtual backsight, *Backsightxxxx* (where xxxx is a unique suffix, for example, *Backsight0001*), using the current instrument orientation as the azimuth.

Tip - If the instrument is correctly set up and oriented, you are satisfied that the last station setup is still valid, and you wish to continue observing points from this station, select *Survey / Use last* to use the last completed station setup.

Note - Before you can use the *Turn to* or *Joystick* functions to turn a servo or robotic instrument, you must have a current station setup.

To perform a station setup:

1. From the main menu, select *Survey / Station setup* , *Station setup plus* , *Resection* , or *Reflines*.

Note - If you have only one style, it is automatically selected.

Set the [corrections](#) associated with the instrument.

If the *Corrections* form does not appear, set the corrections by selecting *Options* from the *Station setup* screen. To have the *Corrections* form display on startup, select the *Show corrections on startup* option.

For some instruments, the Trimble Survey Controller software automatically checks to see if various corrections (PPM, prism constant, and curvature and refraction) are being applied correctly. When you select *Station setup*, messages showing what has or has not been checked are displayed in the status line. If the Trimble Survey Controller software finds that the corrections are being applied twice, a warning message appears. When using the 5600 3600 instrument style, all corrections are applied in Trimble Survey Controller.

Note - When using a non-Trimble instrument, you must select the correct survey style **before** you connect the controller to the instrument. Otherwise, the instrument and controller may fail to connect.

2. Enter the instrument point name and the instrument height.

When measuring to the bottom notch on a Trimble VX/S Series instrument, tap the advanced pop-up arrow () and then select *Bottom notch*. Enter the height measured to the top ridge of the bottom notch on the instrument.

Trimble Survey Controller corrects this measured slope value to true vertical and adds the offset 0.158 m (0.518 sft) to calculate true vertical to the trunnion axis.

Note - If you select *Bottom notch*, the minimum slope distance (Hm) that you can enter is 0.300 meters. This is approximately the minimum slope distance that can be physically measured. If this minimum is too low, you must measure to the top mark.

For details, see the following figure and table.

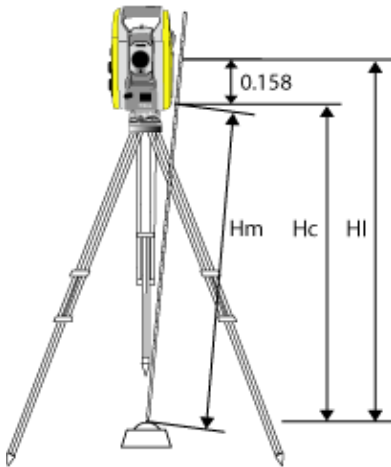

0.158m	Offset from bottom notch to trunnion axis.
Hm	Measured slope distance.
Hc	Hm corrected from slope to true vertical.
HI	Hc + 0.158m. True vertical instrument height.

Note - For a 2D or planimetric survey, leave the *Instrument height* field set to null (?). No elevations will be calculated. Unless you are using a *Scale only* projection, you must define a project height in the coordinate system definition. The Trimble Survey Controller software needs this information to reduce measured ground distances to ellipsoid distances, and to compute 2D coordinates.

3. Enter the backsight point name.

Tip - If the point is available from a linked file, select the linked file for the job and enter the point name in the Instrument point name or *Backsight point name* field. The point is automatically copied to the job.

4. Choose an option in the *Method* field. The options are:

- ◆ *Angles and distance* - measure horizontal and vertical angles and slope distance
- ◆ *Angles only* - measure horizontal and vertical angles
- ◆ *H. Angle only* - measure horizontal angle only
- ◆ *Averaged observations* - measure horizontal and vertical angles, and slope distance for a predefined number of observations

5. If necessary, enter the target height for the backsight.

When measuring to the bottom notch on a [Trimble prism base](#), tap the advanced pop-up arrow () and then select *Bottom notch*.

6. Sight the center of the backsight target and tap *Measure*.

Select the *View before storage* check box to view observations before they are stored.

7. If you are performing a [resection](#) or [station setup plus](#) , you can add more backsight points/observations to the station setup.
8. If the residuals for the station setup are acceptable, tap *Close* and then tap *Store*.

Station Setup is complete.

Begin the survey

To do this:

1. From the main menu, select either *Survey / Measure points* or *Survey / Stakeout*.

If you chose *Measure points*:

- a. Enter a point name and code.
- b. Choose one of the methods of observation.
- c. Enter a target height, if required.

When measuring to the bottom notch on a [Trimble prism base](#), tap the advanced pop-up arrow () and then select *Bottom notch*.

- d. Tap *Measure* to observe the point.
- e. Tap *Store* to save the observation to the database.
- f. Tap *Check* to measure check shots to any known points.
- g. Move to the next point and measure it.

If you chose *Stakeout*:

- a. Tap *Add* to add the points you want to stake out to the stakeout list.
- b. Select the point to stake out now, and use the graphics and text to stake out the point.
- c. When the instrument is within the angular tolerance (as indicated by two hollow/outline arrows), tap *Measure*.
- d. Tap *Accept* to view the stakeout deltas.
- e. Tap *Store* to save the point.
- f. Continue until all points have been staked out.
- g. To make a servo instrument turn to the point, tap *Turn*. If *Servo auto turn* is set to HA and VA or HA only, the instrument automatically turns, if it can compute the angle to the point.
- h. To review stored points, select *Review current job* from the *Files* menu.

End the survey

To do this:

1. From the main menu, select *Survey / End survey*.
2. Tap *Yes* to confirm.
3. Turn off the controller.

Warning - The current station setup is lost when you select *End Survey*.

If a survey is running, end it before editing the current survey style or changing survey styles. You must also end the survey before accessing job functions such as copying. For more information, see [Job](#).

For more information, see:

[Station Setup - Single backsights](#)

[Station Setup Plus](#)

[Resection](#)

[Reflines](#)

[Target](#)

[Prism constant](#)

[Measure Points](#)

[Measure Codes](#)

[Remote Object](#)

[Scanning](#)

[Surface Scan](#)

[Tunnels](#)

[Measure a point in two faces](#)

[Measure Rounds](#)

[Station and offset](#)

[Stakeout](#)

[End Survey](#)

Measure Points

The process of recording GPS or conventional instrument data is known as measuring. To measure points, do one of the following:

- From the *Favorites* menu, select *Measure points*.
- From the *Survey* menu, select *Measure points* or *Measure topo*.

- From the Map, select *Measure* (only available when nothing in the map is selected).

The types of points that you can measure depend on your survey style and the survey method used.

Conventional Surveys

In conventional surveys, you can measure the following types of points:

- *Measure topo*
- *Check points*

If you are measuring points with codes, you can use *Measure topo*, but you may find *Measure codes* more useful. *Measure codes* uses a 9-button pallet that makes measuring codes easier and faster.

To measure a line of points at a fixed interval, select *Continuous topo* from the *Survey* menu.

If a point is inaccessible, you can also measure *horizontal angle* and *distance* offsets to the point.

To measure a point that cannot be observed directly with a pole in a plumb position use the *Dual prism* measurement method.

To calculate a center point of a circular object such as a water tank or silo, use the *Circular object* option.

To measure multiple sets of observations, select *Measure rounds* from the *Survey* menu.

To calculate the height of a remote object if the instrument does not support DR mode, or you cannot measure a distance, use the *Remote Object* method.

To automatically store measurements along a remote surface that you have defined, use either the *Scanning* or the *Surface Scan* method.

You can also *Measure a point on two faces*.

Tip - In *Point name* fields there is a *Find* softkey that lets you search for the next available point name. For example, if your job contains points numbered in the 1000s, 2000s and 3000s, and you want to find the next available point name after 1000:

1. In the *Point name* field, tap *Find*. The *Find next free point name* screen appears.
2. Enter the point name you want to start searching from (in this example, 1000) and tap *Enter*.

The Trimble Survey Controller software searches for the next available point name after 1000 and inserts it in the *Point name* field.

GPS Surveys

In GPS surveys, you can measure the following types of points:

In real-time GPS surveys, you can measure the following types of points:

- [Topo point](#)
- [Observed control point](#)
- [Calibration point](#)
- [Rapid point](#)

To measure a line of points at a fixed interval, select [Continuous topo](#) from the *Survey* menu.

In postprocessed surveys, you can measure the following types of points:

- [Topo point](#)
- [Observed control point](#)
- [FastStatic points](#)

To measure a line of points at a fixed interval, select [Continuous topo](#) from the *Survey* menu.

Measure Codes

To measure and code Conventional or GPS observations in one step, select the feature code you want to measure and store from a coding form containing nine buttons that you can define. You can define multiple groups or pages of codes, each consisting of up to nine codes.

In the *Measure codes* form, if you activate the *Code* button, it affects the behavior of the nine configurable code buttons. When you then tap one of the configurable code buttons, the code on that button is added to the code field at the bottom of the *Measure codes* form. Typically, you can use the *Code* button to combine codes from multiple code buttons where features combine, either from the current group, or a combination of groups. You can also use it to enter a new code.

If a code has attributes, the attribute values appear at the bottom of the *Measure codes* form. You cannot directly edit these attribute values in the form. To change the attribute values, do one of the following:

- Tap *Attrib* in the *Measure codes* form.
- Tap *Attrib* in the *Measure topo/Measure points* form.
- If *Prompt for attributes* is enabled, enter the attributes when prompted.
 - ◆ If you pre-entered attributes using the *Attrib* softkey, you are not prompted for attributes.

For more information, see [Using Feature Codes with Predefined Attributes](#).

To add a feature code group and assign codes to the buttons:

1. Select *Survey / Measure codes* and then tap *Add group*.
2. Enter a *Group name* and then tap *OK*.
3. To add a code to a button:
 - ◆ Tap and hold on the button. When the tooltip message appears, remove the stylus from the screen. In the dialog that appears, enter the code, or select a code from the feature code library.
 - ◆ Navigate to the button using the arrow keys, and then press the Space key, which emulates the

'tap and hold' action.

In the dialog that appears, enter the code, or select a code from the feature code library. Tap *OK*. The code you entered now appears on the button.

If required, you can also enter additional [descriptions](#).

4. To add another code, or remove a code from a button, repeat Step 3.
5. To add more groups of feature code buttons, tap *Add group*.

To navigate to a particular group, select it from the drop down list in the top left of the form. Alternatively, use A - Z to quickly switch to group pages 1 - 26. This method is not available if the *Code* button is enabled.

To measure and code observations using Measure codes:

1. Select *Survey / Measure codes*.
2. To initiate a measurement, activate the button using one of the following methods:
 - ◆ Tap the button.
 - ◆ Press the numeric key on the controller keyboard corresponding to the button. Keys 7, 8, 9, activate the top row of buttons, keys 4, 5, 6 activate the middle row of buttons, keys 1, 2, 3 activate the bottom row of buttons.
 - ◆ Use the arrows keys on the controller to navigate to the button and then press **Enter**.

If the code has attributes, the attribute values appear at the bottom of the *Measure codes* form.

3. To automatically start the measurement when the button is selected, tap *Options* and then select the *Auto measure* check box.

Note - When the method is set to *Distance offset*, *Angles only*, and *H Angle only*, *Automeasure* is temporarily paused.

4. To configure the position of the highlight for the next code, tap *Options* and then configure the *Direction* of the *Template pickup*.
5. The code field is set to the code on the button and the measurement is initiated. The measurement is automatically stored depending on the setting in *Options*:
 - ◆ In a GPS survey, set the Topo point options to *Auto store point*.
 - ◆ In a Conventional survey, clear the *View before storage* check box in the *Measure point options* form.

If descriptions were defined on the Measure codes button, the descriptions are also set to the descriptions on the button.

6. Once you store the measurement, the *Measure codes* form appears, ready for the next measurement.

Tap [Enter] to measure a point with the same code again, or use one of the methods described in step 2 above to measure with a different code.

The *Measure topo/Measure points* form, where the measurement was initiated, remains open in the background. If you need to change the point name or measurement method, tap *Switch to* to switch to this form, change the fields as required and then tap *Switch to* again to return to the *Measure codes* form.

Using Template pickup

Use the *Template pickup* feature to automatically move the highlight from the current button to the next button after storing a measurement. Template pickup is particularly useful when coding observations in a regular pattern, for example, across a road template.

To configure template pickup, tap *Options* and then configure:

- The template pickup *Direction*:
 - ◆ Left to right
 - ◆ Right to left
 - ◆ Zig zag
- The *Number of template elements*:
 - ◆ The *Number of template elements* configured should match the number of elements across the template, and the number of buttons configured in *Measure codes*.

To skip a code, tap a different button, or use the arrow keys to select an alternative code button.

Notes

- The first time that you use *Measure codes*, the measurement may not begin automatically if you have not defined the point name and target height. If this occurs, complete these fields and then tap *Measure* to begin the measurement.
- To change target or antenna heights, tap the target icon in the status bar.
- During a measurement, you can change the point name, and the target or antenna height and code. However, you can do this only if you start editing before the observation is stored. Alternatively, tap *Esc* as soon as the measurement begins, make the required changes, then tap *Measure* to restart the measurement.
- To change the EDM or measurement method, tap *Esc* during the measurement, make the required changes, then tap *Measure* to restart the measurement.
- To change the point name or measurement method before you start a measurement, tap *Switch to* to switch to the *Measure topo/Measure points* form, change the fields as required and then tap *Switch to* again to return to the *Measure codes* form.
- To measure a point with a null code, activate a blank code button. Alternatively, tap *Code*, ensure that the code field is empty and then tap *Measure*.
- To store a [note](#) with an observation, tap .
- To delete an entire group of codes, select the group and then tap *Delete*.

Stringing support

Measure codes has '+' and '-' softkeys that enable you to apply a suffix to the code on the button. This is useful when you use the stringing method for feature coding.

You can configure the suffix to 1, 01, 001, or 0001.

When the suffix is configured to 01, tap '+' to increase the code "Fence" to "Fence01". Tap '-' to decrease the code by 01.

Note - The suffix is applied to the code on the button. If the suffix is 01 and you select '+' for a button that has the code "Fence01", the code increases to "Fence0101".

Tap *Find* to find the next available string for the currently highlighted button.

Attributes and Base codes

You can configure the Trimble Survey Controller software to provide attributes for the complete code, or from a portion of the code - the "base code".

Typically, base codes are used when you use the '+' and '-' softkeys to "string" feature codes. For example, when you code a fence where all observations coded "Fence01" are joined together and all observations coded "Fence02" are joined together, and so on, and they all have the same attributes. In this example, you can create feature code libraries that contain all the "Fence**" codes, or contain just the base code "Fence".

If you do not string codes, or if you do string codes but you include the entire code in the feature code library, then you are not using base codes. Disable *Use attributes of base code* (clear the check box).

If you do string codes, and the feature and attribute library includes only the base code, then enable *Use attributes of base code* (select the check box).

In the Trimble Survey Controller software, you can use the extra power of Measure codes to create a button that contains a numeric or alpha-numeric code (the base code) and then append a numeric suffix using the '+' or '-' softkeys. For codes entered into any other code field in the Trimble Survey Controller software, you cannot use the '+' or '-' softkeys to append a suffix, so when you use base codes, the software can only attempt to determine the base code by stripping the numeric characters from the end of the codes.

The following rules help to explain the base code:

- **In Measure codes:**

1. When *Use attributes of base code* is disabled, the code displayed on a button is the base code.
 - ◇ Enter "Fence", string the code to become "Fence01", the attributes are derived from "Fence01".
2. When *Use attributes of base code* is enabled, the code entered on a button is the base code.
 - ◇ Enter "Fence", string the code to become "Fence01", the attributes are derived from "Fence".
3. If you edit or change the code on a button, the base code resets, using rule 1 or rule 2 above.
4. If you change the configuration of the *Use attributes of base code* setting, the base code resets, using rule 1 or rule 2 above.
5. When Measure codes 'passes' the code to the Measure topo, or Measure points system, the base code from within Measure codes is retained.

- **In any other code field** of the Trimble Survey Controller software:

1. When *Use attributes of base code* is disabled, the code entered is the base code.
2. When *Use attributes of base code* is enabled, the base code is determined by 'internally' stripping any numeric characters from the end of the code.

3. When *Use attributes of base code* is enabled, and you edit a code that is 'passed' from Measure codes, the base code is re-derived by 'internally' stripping any numeric characters from the end of the code.

Notes

- If you use attributes and numeric codes with a string suffix, you must use Measure codes to define the suffix and start the measurement. Measure codes understands where the code ends and the suffix starts. If you do not use Measure codes, the entire numeric code + suffix will be treated as the code, the suffix cannot be determined, and attributes for the base code will not be available.
- To configure *Use attributes of base code*, from within Measure codes, use the up arrow softkey to select *Options*, and then select the check box as required.
- The *Use attributes of base code* setting is configured within Measure codes, but is applied throughout the Trimble Survey Controller software.
- If you edit the code on a button when *Use attributes of base code* is disabled, the entire code from the code button is displayed in the Edit field.
- If you edit the code on a button when *Use attributes of base code* is enabled, the base code is displayed in the Edit field.
 - ◆ The code on the button is "Fence01" and the base code is "Fence". If you edit this code, the base code "Fence" is displayed.
- You can string alphanumeric codes when *Use attributes of base code* is disabled. The code displayed on the button is the base code.
- You cannot string numeric only codes when *Use attributes of base code* disabled.

Tip - If you use multiple codes with attributes, enter all the codes **before** you enter the attributes.

Sharing Measure codes groups between controllers

The groups, and the codes within each group, are stored in a Measure Codes Database file (*.mcd).

If you use a feature and attribute library, the Measure Codes Database file (*.mcd) is tied to that feature and attribute library and has a matching name. If you use the same feature and attribute library on other controllers, you can copy the *.mcd file to use in the other controllers. To use the feature and attribute library *.mcd file, you must assign the feature and attribute library to the job.

If you do not use a feature and attribute library, a [Default.mcd] file is created. The [Default.mcd] file can also be copied to other controllers. When the Trimble Survey Controller software does not have a feature and attribute library assigned to a job, the [Default.mcd] file is used in *Measure codes*.

Roading

You can stake out, or measure your position relative to a:

- Trimble road
- road defined in a GENIO file

And you can stake out:

- road defined in a LandXML file

For more information, see:

[Key in - Roads](#)

[Key in - Templates](#)

[Stakeout - Roads](#)

[Trimble Roads](#)

[GENIO roads](#)

[LandXML roads](#)

Tunnels

You can scan or manually measure positions relative to a tunnel.

For more information, see:

[Key in - Tunnels](#)

[Survey - Tunnels](#)

Stakeout - Overview

In a real-time GPS survey or a conventional survey, you can stake out points, lines, arcs, polylines, alignments, roads, and DTMs.

To stake out an item:

- Define the item to be staked out.
- From the map, or from *Survey / Stakeout*, select the item to be staked out.
- Navigate to the point, or direct the person holding the rod to the point.
- Mark the point.
- Measure the point (optional).

You can define the item to be staked out in the *Key in* menu, or you can use a [linked file](#) to add the points to the stakeout list.

You can define the item to be staked out:



- in the *Key in* menu
- with a [linked CSV or job file](#)
- from lines and arcs uploaded with the job file
- from an active map file
- from an alignment (.rxl) or road (.rxl, crd, .inp, .mos, or .xml)

To stake out a line between two points without keying the line into the job database, you can select two points from the map, tap and hold in the map to access the pop-up menu and then select *Stake out line*.

To use GPS to stake out lines, arcs, Digital Terrain Models, and roads, you must define a projection and datum transformation.

Warning - Do not change the coordinate system or calibration after you have staked out points.

For more information, see:

[Arcs](#)

[Lines](#)

[Points](#)

[Alignments \(polylines\)](#)

[Roads](#)

[DTMs](#)

[Stakeout - Display mode](#)

[Stakeout - Options](#)

[Using the Graphical display](#)

Fast Fix

Tap *Fast fix* to quickly measure and automatically store a construction point. Alternatively, select *Fast fix* from the pop-up menu in the *Point name* field.

Note - In a real-time GPS survey, *Fast fix* uses the *Rapid point* method. In a conventional survey, *Fast fix* uses the current measurement mode.

If you need more flexibility, select *Measure* from the pop-up menu in the *Point name* field.

Typically, a construction point is used in *Cogo - compute points* or *Key in - lines and arcs*.

Construction points are stored in the Trimble Survey Controller database with autopoint names that increment

from Temp0000. They are classified higher than as-staked points and lower than normal points. For more information, see [Database Search Rules](#).

To view construction points in a map or list, tap *Filter* and select them from the *Select filter* list.

Topo Point

This is a previously configured method of measuring and storing a point. Configure this type of point when you create or edit a Survey Style.

Use the *Auto point step size* field to set the increment size for automatic point numbering. The default is 1, but you can use larger step sizes and negative steps.

You can store quality control information with each point measurement. Options may include *QC1*, *QC1 & QC2*, and *QC1 & QC3*, depending on the type of survey.

The *Occupation time* and *Number of measurements* together define the time that the receiver is static while measuring a point and the criteria for both must be met before the point can be stored. When the *Occupation time* and *Number of measurements* criteria have been met, *Store* is available. Alternatively, if *Auto store point* is enabled the point is stored automatically.

During the occupation, the RTK engine in the GNSS receiver converges on a solution and it is this converged solution that is saved in the Trimble Survey Controller job file when the point is stored.

You can configure *Occupation time* and *Number of measurements* criteria in the Survey style or under *Options*.

In an RTK survey, when you select the *Auto tolerance* check box, the software calculates horizontal and vertical precision tolerances that meet the GPS receiver's RTK specifications for the baseline length you are measuring. If you want to enter your own precision tolerances, clear this check box.

Measuring a Topo Point in a GPS Survey

You can measure a topo point in every type of survey except a FastStatic survey.

To measure a topo point:

1. Do one of the following:
 - ◆ From the main menu, select *Survey / Measure points*
 - ◆ Tap *Favorites* and select *Measure points*
 - ◆ From the Map, select *Measure* (only available when nothing in the map is selected).
To automatically start the measurement when you select *Measure* from the map, tap *Options* and then select the *Auto measure* check box.
2. Enter values in the *Point name* and *Code* fields (the *Code* field entry is optional), and select *Topo point* in the *Type* field.

3. Enter a value in the *Antenna height* field and make sure that the setting in the *Measured to* field is set appropriately.
4. When the antenna is vertical and stationary, tap *Measure* to start recording data. The static icon appears in the status bar.

Tip - You can tap *Enter* to accept the measurement before the occupation time or precisions have been satisfied.

5. When the preset occupation time and precisions have been reached, tap *Store*.

Tip - In the survey style, select the *Auto store point* check box to automatically store the point when the preset occupation time and precisions have been met.

Check Point

GPS

In a real-time GPS survey, measure a point twice. Give the second point the same name as the first point. If the duplicate point tolerances are set to zero, the Trimble Survey Controller software warns that the point is a duplicate when you try to store it. Select *Store as check* to store the second point as a check class point. For more information, see [Duplicate point: Out of tolerance screen](#).

Conventional

In a conventional total station survey, tap *Check* to measure a check class point.

To measure a check point:

1. In the *Point name* field, enter the name of the point to check.
2. In the *Method* field, select a measurement method and enter the required information in the fields that appear.
3. In the *Target height* field, enter the height of the target and then tap *Measure*.

When measuring to the bottom notch on a [Trimble prism base](#), tap the advanced pop-up arrow () and then select *Bottom notch*.

If you did not select the *View before storage* check box, the point is stored with a classification of *Check*. If you selected the *View before storage* check box, the check shot deltas appear on the *Check shot* screen.

When you observe the point, if the station setup is the same as when you originally measured the point, the deltas are the difference in values between the original observation and the check observation. The deltas displayed are horizontal angle, vertical distance, horizontal distance, and slope distance.

If the station setup is different from when you originally measured the point, the deltas are in terms of

the best coordinates from the original point to the check point. The deltas displayed are azimuth, vertical distance, horizontal distance, and slope distance.

4. Tap *Enter* to store the check point. Tap *Esc* to abandon the measurement.

Tap *Chk BS* to display the *Check backsight* screen. This is similar to the *Check point* screen, but the *Point name* field shows the backsight of the current station setup. You cannot edit this field.

To observe a check shot to the backsight, use the same procedure as described above.

To return to the *Check point* screen, tap *Chk topo*.

End Survey

To end the current survey, select *End survey* from the *Survey*.

When you end a GPS survey, the software asks you if you want to power down the receiver.

When you end a Conventional survey with Robotic instruments, the software asks you if you want to power down the instrument. If the instrument is powered down this way, starting the survey again automatically starts the instrument.

Warning - The current station setup is lost when you select *End Survey*.

When you are using an Integrated survey, you get choose to end the GPS survey, the Conventional survey, or both surveys.

Survey - Conventional

Measuring topo points in a Conventional Survey

To measure a topographic point using the Trimble Survey Controller software and a conventional instrument:

1. From the main menu, select *Survey* and then perform a [station setup](#), [station setup plus](#), [resection](#), or [refine](#).
2. From the *Survey* menu, select *Measure topo*.
3. Enter a value in the *Point name* field.
4. If necessary, enter a feature code in the *Code* field.
5. In the *Method* field, select a measurement method.
6. Enter a value in the *Target height* field and then tap *Measure*.

When measuring to the bottom notch on a [Trimble prism base](#), tap the advanced pop-up arrow () and then select *Bottom notch*.

If you selected the [View before storage](#) check box in the survey style, the measurement information appears on the screen. If necessary, edit the target height and code. Tap the view display button on the left of the measurement information to change the display and then do one of the following:

- To store the point, tap *Store*.
- Turn the instrument to the next point and then tap *Read*. The last point is stored and a measurement is made to the next point.

If you did not select the [View before storage](#) check box, the point is stored automatically and the point name increments (based on the [Auto point step size](#) setting). The Trimble Survey Controller software stores the raw observations (HA, VA, and SD).

Notes

- If you selected the [Auto average](#) option, and an observation to a duplicate point is within the specified duplicate point tolerances, the observation and the computed average position (using all the available point positions) are automatically stored.
- To produce an averaged coordinate, Trimble Survey Controller software averages the grid coordinates calculated from the underlying coordinates or observations. Observations that do not allow a grid coordinate to be resolved (for example, angles only observations) are not included in the average coordinate.

To change the settings for the current survey, tap *Options*. You can not change the current survey style or the system settings.

If you are using a servo or robotic instrument to measure a known (coordinated) point, tap *Turn*. Alternatively, with a servo instrument, set the *Servo auto turn* field in the survey style to *HA & VA*, or *HA only* to automatically turn the instrument to the point.

Tips

- You can tap *Enter* while measuring an *Averaged observations* to accept the measurement before the required number of observations has been completed.
- You can tap *Enter* while measuring a *Direct Reflex (DR)* point with a defined standard deviation to accept the measurement before the standard deviation has been satisfied.

If you are measuring topo points with feature codes, you may find [Measure codes](#) faster and easier to use than *Measure topo*.

If you are using a Leica TPS1100 instrument with *Measure topo*, you can initiate the measurement on the instrument and then store the measurement in the Trimble Survey Controller software. For more information on how to do this and on how to configure the Leica TPS1100 instrument, see [Configuring a Leica TPS1100 Instrument to Record data to Trimble Survey Controller](#).

Measurement Methods

For more information on the different measurement methods see the following:

[Angles and distance](#)

[Angles only, H.Angle only](#)

[Angle Offset, H. Angle Offset, and V. Angle Offset](#)

[Distance offset](#)

[Dual Prism](#)

[Circular Object](#)

[Remote Object](#)

[Scanning](#)

[Surface Scan](#)

You can also [Measure a point on two faces](#).

Use the *Auto point step size* field to set the increment size for automatic point numbering. The default is 1, but you can use larger step sizes and negative steps.

Select the *View before storage* check box to view observations before they are stored.

Station Setup

In a conventional survey, you must complete a station setup to orientate the instrument:

1. From the main menu, select *Survey / (Selected survey style) / Station setup*.

The menu that appears varies according to whether or not you have a current station setup.

Note - If you have only one style, it is automatically selected.

2. Set the [corrections](#) associated with the instrument.

If the *Corrections* form does not appear, tap *Options* from the *Station setup* screen to set the corrections.

To make the *Corrections* form appear on startup, select the *Show corrections on startup* option.

3. Enter the instrument point name and the instrument height. If the point is not already in the database, you can key it in or leave it as null.

When measuring to the bottom notch on a Trimble VX/S Series instrument, tap the advanced pop-up arrow () and then select *Bottom notch*. Enter the height measured to the top ridge of the bottom notch on the instrument.

Trimble Survey Controller corrects this measured slope value to true vertical and adds the offset 0.158 m (0.518 sft) to calculate true vertical to the trunnion axis.

Note - If you select *Bottom notch*, the minimum slope distance (Hm) that you can enter is 0.300 meters. This is approximately the minimum slope distance that can be physically measured. If this minimum is too low, you must measure to the top mark.

Notes

- ◆ If the coordinates for the instrument point are not known, perform a [resection](#) to known points to coordinate the point.
- ◆ For a 2D or planimetric survey, leave the *Instrument height* field set to null (?). No elevations are calculated. Unless you are using a Scale only projection, a project height must be defined in the coordinate system definition. Trimble Survey Controller software needs this information to reduce measured ground distances to ellipsoid distances and to compute 2D coordinates.

4. Enter the backsight point name and the target height. If there are no coordinates for the point, you can key in an azimuth.

When measuring to the bottom notch on a [Trimble prism base](#), tap the advanced pop-up arrow () and then select *Bottom notch*.

Notes

- ◆ If you do not know the azimuth, you can enter an arbitrary value and then edit the azimuth record later, in review.
- ◆ If you cannot determine the coordinates for the instrument or backsight point, you can key them in or measure them later using GPS (provided that there is a valid GPS site calibration). The coordinates of any points measured from that station are then computed.
- ◆ When you enter the instrument point later, make sure that you choose to overwrite the original instrument point in the *Duplicate point* form. The coordinates of any points measured from that station are then computed.
- ◆ You can use the Point manager to edit the coordinates of the instrument point. If you do, then the positions of all records that are computed from that station setup position may change.
- ◆ You can use Point manager to edit the coordinates of the backsight point. If you edit the point record that is used as a backsight in a station setup with a computed azimuth to the backsight, then the positions of all records that are computed from that station setup may change.

Tip - If the point is available from a linked file, select the linked file for the job and then enter the point name in the *Instrument point name* or *Backsight point name* field. The point is automatically copied to the job.

5. Choose an option in the *Method* field. The options are:

- ◆ Angles and distance - measure horizontal and vertical angles and slope distance
- ◆ Averaged observations - measure horizontal and vertical angles and slope distance for a predefined number of observations
- ◆ Angles only - measure horizontal and vertical angles
- ◆ H. Angle only - measure horizontal angle only
- ◆ Angle offset - measure the slope distance first, the instrument can then be repointed and then measure the horizontal and vertical angles
- ◆ H. Angle offset - measure the vertical angle and slope distance first, the instrument can then be repointed and then measure the horizontal angle
- ◆ V. Angle offset - measure the horizontal angle and slope distance first, the instrument can then be repointed and then measure the vertical angle
- ◆ Distance offset - enter the left/right, in/out or V.Distance offset from the target to the object when a point is inaccessible and then measure horizontal and vertical angles and slope distance to the offset object

When using an offset method, tap *Options*, and set the *Offset directions* perspective.

6. Sight the center of the backsight target and then tap *Measure*.

7. If the residuals for the station setup are acceptable, tap *Store*.

Tip - To change the display, tap the view display button on the left of the measurement information.

Note - The residuals are the differences between the known position and the observed position of the backsight point.

Station setup is complete.

Tip - To get the most out of the Station setup routine, tap *Options* to configure *Station setup* to match the way that you prefer to work. For more information, see [Perform a station setup](#).

Note - If you want to measure more than one backsight point, use [Station setup plus](#).

Loading station data to a Trimble 5600 and ATS instrument

When you complete a station setup, Station setup plus, Resection, or Refline station setup with a Trimble 5600 or ATS instrument, the Trimble Survey Controller software loads the station information into the instrument.

Notes

- The instrument does not accept a null instrument height. If the instrument height is set to null in the Trimble Survey Controller software, then the software writes 0 to label V,50 and clears bit 1 in label PV,52.
- The instrument does not accept a null H.Distance. If the Trimble Survey Controller software cannot compute an H.Distance between the instrument and the backsight point (that is, Keyed in azimuth, Angles only, or H.Angle only backsight observation) then the software writes 0 to label PV,51.

For more information, see:

- [Conventional surveys](#)
- [Station setup plus](#)
- [Resection](#)
- [Traverse](#)
- [Advanced Geodetics support](#)

Station setup plus

In a conventional survey, use *Station setup plus* to perform a station setup on a known point by making observations to one or more backsight points.

Warning - If the station setup point is a traverse station that you plan to adjust, do not measure more than one backsight point. Clear the *Backsight* check box for any additional points so that they are measured as foresights.

For more details, see:

- [Performing a Station setup plus](#)
- [Station setup - Residuals screen](#)
- [Skipping observations](#)
- [Point - Residuals screen](#)
- [Point details screen](#)
- [Station setup results screen](#)

Performing a Station setup plus

To perform a Station setup plus:

1. From the main menu, select *Survey / Station setup plus*.
2. Set the [corrections](#) associated with the instrument.

If the *Corrections* form does not appear, tap *Options* and then select the *Show corrections on startup* check box.

3. Enter the instrument point name. If the point is not already in the database, key it in or leave it as null.

If the coordinates for the instrument point are not known, perform a [Resection](#) to known points. This will provide the coordinates.

4. If applicable, enter the instrument height and then tap *Accept*.

When measuring to the bottom notch on a Trimble VX/S Series instrument, tap the advanced pop-up arrow () and then select *Bottom notch*. Enter the height measured to the top ridge of the bottom notch on the instrument.

Trimble Survey Controller corrects this measured slope value to true vertical and adds the offset 0.158 m (0.518 sft) to calculate true vertical to the trunnion axis.

Note - If you select *Bottom notch*, the minimum slope distance (Hm) that you can enter is 0.300 meters. This is approximately the minimum slope distance that can be physically measured. If this minimum is too low, you must measure to the top mark.

- For a 2D or planimetric survey, leave the *Instrument height* field set to null (?). No elevations is calculated.

- Once the station setup is started, you cannot enter a different instrument height.

Warning - Before you continue, tap *Options* and make sure that the *Face order* setting is correct. You cannot change this setting after you start measuring points.

5. Enter the first backsight point name and the target height, if applicable. If there are no coordinates for the point, you can key in an azimuth.

When measuring to the bottom notch on a [Trimble prism base](#), tap the advanced pop-up arrow () and then select *Bottom notch*.

If the point is available from a linked file, select the linked file for the job and then enter the point name in the *Instrument point name* or *Backsight point name* field. The point is automatically copied to the job.

Note - To include foresight points during Station setup plus, clear the *Backsight* check box. Foresight points do not contribute to the station setup result.

6. Choose an option in the *Method* field.
7. Sight the target and then tap *Measure*.

The *Station setup residuals* screen appears.

See the following sections for more information on what do next.

Skipping observations

When using *Automate rounds* you can configure the software to automatically skip obstructed foresight targets.

If the instrument cannot measure the point and *Skip obstructed foresights* is **enabled**, it skips that point and moves onto the next point in the rounds list.

If the instrument cannot measure the point and *Skip obstructed foresights* is **disabled**, a message appears after 60 seconds to indicate that the prism is obstructed.

The Trimble Survey Controller software continues to try to measure to the target until instructed to skip the point. To do this, tap *Ok* for the obstructed prism message, tap *Pause* and then tap *Skip*.

When the Trimble Survey Controller software reaches the end of a rounds list in which points have been skipped, the following message appears:

Observe skipped points?

Tap *Yes* to observe the points that were skipped during that round. The observations can be skipped again if required. Tap *No* to end the round.

If a point is skipped in one round, all subsequent rounds continue to prompt for observations to that point.

When one observation from a pair of face 1 and face 2 observations has been skipped, the unused observation is automatically deleted by the Trimble Survey Controller software. Deleted observations are stored in the Trimble Survey Controller database and can be undeleted. Undeleted observations can be processed in the office software, but are not automatically used to recompute Mean Turned Angle (MTA) records in the Trimble Survey Controller software.

Backsight observations cannot be skipped using the *Skip obstructed foresights* option.

Station setup - Residuals screen

The *Station setup residuals* screen lists the residuals for each point observed in the station setup.

Use the *Station setup residuals* screen to do the following:

- To observe more points, tap + *Point*.
- To view the Station setup results, tap *Results*.
- To store the station setup, tap *Results* and then tap *Store*.
- To view/edit the details of a point, highlight the point and then tap *Details*.
- To view/edit the residuals of each individual observation to a point, tap the point in the list once.
- To start measuring rounds of observations to the points, tap *End face*.

Tips

- To highlight an item in a list, tap and hold the item for at least half a second.
- To sort a column in ascending or descending order, tap the column header. Tap the *Point* column header to sort the point in ascending or descending observed order.
- To change the residual display view, select an option from the drop-down list in the *Residuals* screen.
- To navigate to a point, tap + *Point* and then tap *Navigate*.

Notes

- A residual is the difference between the known position and the observed position of the backsight point(s).
- A foresight point that does not yet exist in the database has null residuals in the *Residuals* form.
- You cannot add the same point to a station setup more than once. To take further measurements to points already measured, select *End Face*. For more information, see [Measuring Rounds in Station setup plus or Resection](#).

Point - Residuals screen

The *Point residuals* screen lists the residuals for each observation to a point in the station setup.

Use the *Point residuals* screen to do the following:

- To disable an observation, highlight it and then tap *Use*.
- To view the details of an observation, highlight it and then tap *Details*.
- To return to the *Station setup residuals* screen, tap *Back*.

Note - If you have measured face 1 and face 2 observations to a point, turning off the observation for one face will also turn off the observation for the other face.

Warning - If you turn off some (but not all) of the observations to a backsight point, the solution for the resection will be biased. There will be a different number of observations to each backsight point.

Point details screen

Use the *Point details* screen to:

- view the mean observation for a point in the station setup
- change the target height and/or prism constant for all observations to a point

Station setup results screen

The *Station setup results* screen shows information about the station setup solution.

Use the *Station setup results* screen to:

- return to the *Station Setup Residuals* screen (tap *Esc*)
- store the station setup (tap *Store*)

Note - During a *Station setup plus*, nothing is stored in the job until you tap *Store* in the *Results* screen.

Station setup is complete.

For more information, see:

- [Measuring Rounds in Station setup plus or Resection](#)
- [Advanced Geodetics support](#)
- [Conventional surveys](#)
- [Resection](#)
- [Traverse](#)

Measuring Rounds in Station setup plus or Resection

This topic describes how to measure multiple sets (rounds) of observations during a *Station setup plus* or *Resection*.

A round can consist of either:

- a set of single face 1 observations
- a set of matched face 1 and face 2 observations

Using *Station setup plus* or *Resection*, measure the points that you want to include in the rounds. When the rounds list has been built, tap *End Face*.

Trimble Survey Controller software:

- Directs you to change face when required. With servo-driven instruments, this happens automatically.
- Defaults to the correct point details for each observed point.
- Displays the results. This allows you to delete bad data.

For more details, see:

- [Building a rounds list](#)
- [Measuring rounds of observations](#)
- [Skipping observations](#)
- [Residuals screen](#)
- [Point - Residuals screen](#)
- [Point details screen](#)
- [Automated rounds](#)

Building a rounds list

The rounds list contains the points used in the rounds observations. As each point is added to a *Station setup plus* or *Resection*, Trimble Survey Controller software automatically builds this list. For more information, see [Station setup plus](#) or [Resection](#).

When the rounds list is complete, tap *End face*. Trimble Survey Controller software prompts you for the next point to be measured in the rounds of observations.

Notes

- You can not edit the rounds list. Before you tap *End face*, be sure to observe all points to include in the rounds observations.
- The top of the *Measure rounds* screen shows which face the instrument is on, the number of the current round, and the total number of rounds to be measured (shown in brackets). For example, Face 1 (1/3) shows that the instrument is on face 1 of the first round of three.

Measuring rounds of observations

Once the rounds list has been built, tap *End face*. Trimble Survey Controller software enters the default point name and target information for the next point in the rounds. To measure a point, tap *Measure*. Repeat this until all observations in the round are completed.

When all observations are complete, Trimble Survey Controller software shows the [Residuals screen](#).

Notes

- When using servo or robotic instruments, check that the instrument has sighted the target accurately. Manually adjust it if necessary. Some instruments can perform accurate sighting automatically. For information on the instrument specifications, refer to the instrument manufacturer's documentation.
- If you are using a servo or robotic instrument to measure a known (coordinated) point, tap *Turn*. Alternatively, with a servo instrument, set the *Servo auto turn* field in the survey style to *HA & VA*, or *HA only* to automatically turn the instrument to the point.
- If you tap *Esc* in the *Measure* screen, the current round is discarded.

Skipping observations

When using *Automate rounds* you can configure the software to automatically skip obstructed foresight targets.

If the instrument cannot measure the point and *Skip obstructed foresights* is **enabled**, it skips that point and moves onto the next point in the rounds list.

If the instrument cannot measure the point and *Skip obstructed foresights* is **disabled**, a message appears after 60 seconds to indicate that the prism is obstructed.

The Trimble Survey Controller software continues to try to measure to the target until instructed to skip the point. To do this, tap *Ok* for the obstructed prism message, tap *Pause* and then tap *Skip*.

When the Trimble Survey Controller software reaches the end of a rounds list in which points have been skipped, the following message appears:

Observe skipped points?

Tap *Yes* to observe the points that were skipped during that round. The observations can be skipped again if required. Tap *No* to end the round.

If a point is skipped in one round, all subsequent rounds continue to prompt for observations to that point.

When one observation from a pair of face 1 and face 2 observations has been skipped, the unused observation is automatically deleted by the Trimble Survey Controller software. Deleted observations are stored in the Trimble Survey Controller database and can be undeleted. Undeleted observations can be processed in the office software, but are not automatically used to recompute Mean Turned Angle (MTA) records in the Trimble Survey Controller software.

Backsight observations cannot be skipped using the *Skip obstructed foresights* option.

Residuals screen

At the end of each round, the *Residuals* screen appears. For more information, see [Station setup plus](#) or [Resection](#).

After you measure rounds, *Std Dev* becomes available in the *Residuals* screen. To view the standard deviations of the observations for each point, tap *Std Dev*.

Notes

- To change the residual display view, use the drop-down list in the *Residuals* screen.
- During a station setup plus or resection, nothing is stored to the job until you tap *Close* and *Store* to complete the station setup.

Point - Residuals screen

The *Point - Residuals* screen shows the residuals for the individual observations to a particular point. For more information, see [Station setup plus](#) or [Resection](#).

Note - If you have measured both face 1 and face 2 observations to a point, when you turn off a face 1 observation, you also turn off the corresponding face 2 observation. Similarly, when you turn off a face 2 observation, you also turn off the corresponding face 1 observation.

Point details screen

The *Point details* screen shows the point name, code, backsight status, target height, prism constant, mean observation, and standard errors for the observed point. For more information, see [Station setup plus](#) or [Resection](#).

Automated rounds

The *Automate rounds* option is available for Trimble VX/S Series and 5600 instruments. When you select *Automate rounds*, the instrument automatically completes all rounds after the rounds list has been built.

If you tap + *Round* after the instrument has completed the required number of rounds, the instrument performs one more round of observations. If you want the instrument to perform more than one extra round, enter the total number of required rounds **before** you tap + *Round*.

For example, to measure three rounds automatically, and then measure another three rounds:

1. Enter 3 in the *Number of rounds* field.
2. Once the instrument has measured 3 rounds, enter 6 in the *Number of rounds* field.
3. Tap + *Round*. The instrument measures the second group of 3 rounds.

Note - Targets observed without Autolock are automatically paused.

Station Elevation

In a conventional survey, use the station elevation function to determine the elevation of the instrument point by making observations to points with known elevations.

Note - Use only points that can be viewed as grid coordinates. (The station elevation calculation is a grid calculation.)

A station elevation needs at least one of the following:

- one angles and distance observation to a known point, or
- two angles only observations to different points

To perform a station elevation:

1. From the main menu, select *Survey* and then perform a [station setup](#) , [station setup plus](#) , [resection](#) , or [refline](#).
2. Select *Survey / Station elevation*. The instrument point name and code appear. If you entered the instrument height during the station setup, that also appears. Otherwise, enter the instrument height now. Tap *Accept*.

When measuring to the bottom notch on a Trimble VX/S Series instrument, tap the advanced pop-up arrow () and then select *Bottom notch*. Enter the height measured to the top ridge of the bottom notch on the instrument.

Trimble Survey Controller corrects this measured slope value to true vertical and adds the offset 0.158 m (0.518 sft) to calculate true vertical to the trunnion axis.

Note - If you select *Bottom notch*, the minimum slope distance (Hm) that you can enter is 0.300 meters. This is approximately the minimum slope distance that can be physically measured. If this minimum is too low, you must measure to the top mark.

3. Enter the point name, code, and target details for the point with the known elevation. Tap *Measure*. Once the measurement is stored, the *Point residuals* appear.
4. From the *Point residuals* screen, tap one of the following softkeys:

- ◆ + *Point*, to observe additional known points
- ◆ *Details*, to view or edit point details
- ◆ *Use*, to enable or disable a point

5. To view the station elevation result, tap *Close* in the *Point residuals* screen. To accept the result, tap *Store*.

Note - The elevation determined through this station elevation method overwrites any existing elevation for the instrument point.

Resection

In a conventional survey, the resection function is used to perform a station setup and determine coordinates for an unknown point by making observations to known backsight points. The Trimble Survey Controller software uses a least-squares algorithm to compute the resection.

Note - To determine the elevation of a point with known 2D coordinates, perform a station elevation once you have completed a station setup.

A resection needs at least one of the following:

- Two angles and distance observations to different backsight points
- Three angles-only observations to different backsight points
- One angles and distance observation to a close-by point and one angles-only observation to a backsight point. This is a special case called eccentric station setup.

Warning - Do not compute a resection point using WGS84 control and then change the coordinate system or perform a site calibration. If you do, the resection point will be inconsistent with the new coordinate system.

For more details, see:

- [Performing a resection](#)
- [Resection - Residuals screen](#)
- [Point - Residuals screen](#)
- [Point details screen](#)
- [Resection results screen](#)
- [Eccentric station setup](#)

Performing a resection

To perform a resection:

1. From the main menu, select *Survey / Resection*.

Note - If you have only one style, it is automatically selected.

2. Set the [corrections](#) associated with the instrument.

If the *Corrections* form does not appear, tap *Options* and then select the *Show corrections on startup* check box.

3. Enter an instrument point name and instrument height, if applicable.

When measuring to the bottom notch on a Trimble VX/S Series instrument, tap the advanced pop-up arrow () and then select *Bottom notch*. Enter the height measured to the top ridge of the bottom notch on the instrument.

Trimble Survey Controller corrects this measured slope value to true vertical and adds the offset 0.158 m (0.518 sft) to calculate true vertical to the trunnion axis.

Note - If you select *Bottom notch*, the minimum slope distance (Hm) that you can enter is 0.300 meters. This is approximately the minimum slope distance that can be physically measured. If this minimum is too low, you must measure to the top mark.

Note - Once the resection is started you cannot enter a different instrument height.

4. Set the *Compute station elevation* check box and then tap *Accept*.

Note - For a 2D or planimetric survey, clear the *Compute station elevation* check box. No elevations is calculated

Warning - Before you continue, tap *Options* and make sure that the *Face order* setting is correct. You cannot change this setting after you start measuring points.

5. Enter the first backsight point name and the target height, if applicable.

When measuring to the bottom notch on a [Trimble prism base](#), tap the advanced pop-up arrow () and then select *Bottom notch*.

Note - In a resection, you can only use backsight points that can be viewed as grid coordinates. This is because the resection calculation is a grid calculation.

If you perform a Resection or Station setup plus while running an [Integrated Survey](#), you can measure backsight points with GPS. To do this, enter an unknown point name in the point name field. The Trimble Survey Controller software will then ask if you want to measure the point with GPS using the specified point name. The *Measure* softkey will show both a prism and a GPS symbol. The Trimble Survey Controller software will first measure the point with GPS and then perform a measurement with the conventional instrument.

Make sure that you have a site calibration loaded when combining conventional and GPS measurements.

6. Choose an option in the *Method* field.
7. Sight the target and then tap *Measure*.
8. Measure further points.

Note - To include foresight points during resection, clear the *Backsight* check box. Foresight points do not contribute to the resection result.

When two measurements have been completed, the Trimble Survey Controller software can provide navigation information for further points, and a *Navigate* softkey is available. Tap *Navigate* to navigate to another point.

9. When there is enough data for the Trimble Survey Controller software to calculate a resected position, the *Resection residuals* screen appears.

Resection - Residuals screen

The *Resection residuals* screen lists the residuals for each point observed in the resection.

Use the *Resection residuals* screen to do the following:

- To observe more points, tap + *Point*.
- To view the resection results, tap *Close*.
- To store the resection, tap *Close* and then tap *Store*.
- To view/edit the details of a point, highlight the point and then tap *Details*.
- To view/edit the residuals of each individual observation to a point, tap the point in the list once.
- To start measuring rounds of observations to the points, tap *End face*.

Tips

- To highlight an item in a list, tap and hold the item for at least half a second.
- To sort a column in ascending or descending order, tap the column header. Tap the *Point* column header to sort the point in ascending or descending observed order.
- To change the residual display view, select an option from the drop-down list in the *Residuals* screen.

Notes

- A residual is the difference between the known position and the observed position of the backsight point(s).
- A foresight point that does not yet exist in the database has null residuals in the *Residuals* form.
- You cannot add the same point to a resection more than once. To take further measurements to points already measured, select *End Face*. For more information, see [Measuring Rounds in Station setup plus or Resection](#).

Point - Residuals screen

The *Point residuals* screen lists the residuals for each observation to a point in the resection.

Use the *Point residuals* screen to do the following:

- To disable an observation, highlight it and then tap *Use*.
- To view the details of an observation, highlight it and then tap *Details*.
- To return back to the *Resection residuals* screen, tap *Back*.

Note - If you have measured face 1 and face 2 observations to a point, turning off the observation for one face will also turn off the observation to the other face.

Warning - If you turn off some (but not all) of the observations to a backsight point, the solution for the resection will be biased because there will be a different number of observations to each backsight point.

Point details screen

The *Point details* screen shows the mean observation for a point in the resection.

Use the *Point details* screen to do the following:

- change whether the horizontal component or the vertical component of a point will be used in the resection calculation
- change the target height and/or prism constant for all observations to that point

Note - You can only change which components of a point will be used in the resection calculation if you have selected the compute station elevation option, and the observed point has a 3D grid position.

The *Used for* field shows the point components used in the resection calculation. See the following table.

Option	Description
H (2D)	Use only the horizontal values for that point in the calculation
V (1D)	Use only the vertical values for that point in the calculation
H,V (3D)	Use both the horizontal and vertical values for that point in the calculation

Resection results screen

The *Resection results* screen shows information about the resection solution.

Use the *Resection results* screen to do the following:

- To return to the *Resection residuals* screen, tap *Esc*.
- To store the resection, tap *Store*.

Note - During a resection, nothing is stored in the job until you tap *Store* in the *Results* screen.

Resection is complete.

Eccentric station setup

You can use the resection function to perform an eccentric station setup, where the station setup is performed in view of a close-by control point and in view of at least one backsight point. For example, use this setup if you cannot set up over the control point, or you cannot see any backsight points from the control point.

An eccentric station setup needs at least one angles and distance observation to a close-by control point, and one angles-only observation to a backsight point. Additional backsight points can also be observed during an eccentric station setup. You can measure backsight points with angles-only observations or with angles and distance observations.

For more information, see:

- [Measuring Rounds in Station setup plus or Resection](#)
- [Advanced Geodetics support](#)
- [Conventional Surveys](#)
- [Station setup plus](#)
- [Traverse](#)

Reflines

Reflines is the process of establishing the position of an occupied point relative to a baseline. To perform a reflines station establishment, take measurements to two known or unknown baseline definition points. Once this occupation point is defined, all subsequent points are stored in terms of the baseline using station and offset. This method is often used when setting out buildings parallel to other objects or boundaries.

To perform a Reflines station setup:

1. From the main menu, select *Survey / Reflines*.
2. Set the [corrections](#) associated with the instrument.

If the *Corrections* form does not appear, tap *Options* and then select the *Show corrections on startup* check box.

3. Enter an *Instrument point name* and *Instrument height*, if applicable.

When measuring to the bottom notch on a Trimble VX/S Series instrument, tap the advanced pop-up arrow () and then select *Bottom notch*. Enter the height measured to the top ridge of the bottom notch on the instrument.

Trimble Survey Controller corrects this measured slope value to true vertical and adds the offset 0.158 m (0.518 sft) to calculate true vertical to the trunnion axis.

Note - If you select *Bottom notch*, the minimum slope distance (Hm) that you can enter is 0.300 meters. This is approximately the minimum slope distance that can be physically measured. If this minimum is too low, you must measure to the top mark.

4. Tap *Accept*.
5. Enter the *Point 1 name*, and *Target height*.
 - If point 1 has known coordinates, the coordinates are displayed.
 - If point 1 does not have known coordinates, default coordinates are used. Select *Options* to change the default coordinates.

6. Tap *Meas 1* to measure the first point.
7. Enter the *Point 2 name*, and *Target height*.

- If point 1 has known coordinates, a point with known coordinates can be used for point 2.
- If point 1 does not have known coordinates then a point with known coordinates can not be used at point 2.
- If point 1 does not have known coordinates, the default coordinates are used. Select Options to change the default coordinates.
- If point 1 and point 2 had known coordinates the computed refline azimuth is displayed, otherwise the default azimuth 0° is displayed.

8. Enter a *Refline azimuth*, if applicable.
9. Tap *Meas 2* to measure the second point.

The instrument point coordinates are displayed.

10. Tap *Store* to complete the refline station establishment.

Once the Refline setup is stored, all subsequent points are stored in terms of the baseline as a station and offset.

Note - In a refline station establishment, you can only use existing points that can be viewed as grid coordinates. This is because the refline calculation is a grid calculation. You can use 2D and 3D grid coordinates to define the baseline.

Measure Rounds

This topic describes how to measure multiple sets (rounds) of observations with a conventional instrument and the Trimble Survey Controller software.

A round can consist of one of the following:

- a set of single face 1 observations
- multiple sets of single face 1 observations
- a set of matched face 1 and face 2 observations
- multiple sets of matched face 1 and face 2 observations

Rounds can be used in a number of different ways depending on your equipment, the accessibility of points, and the procedures to observe the points, such as the order in which the observations are made.

With a Trimble S8 Total Station, you can use [FineLock](#) mode when measuring to a prism that is more than 20 m away.

To measure rounds of observations:

1. From the main menu, select *Survey* and then perform a [station setup](#) , [station setup plus](#) , [resection](#) , or

refine.

2. From the *Survey* menu, select *Measure rounds*.

3. Tap *Options* to **configure** the rounds options.

Before you start measuring points, make sure that the *Face order* and *Sets per point* settings are correct. You cannot change these settings after you start measuring points.

4. Do one of the following:

- ◆ **Manually build the rounds list** by observing each point to include in the round on the first face.
- ◆ **Load a CSV file** that contains all the points to include in the rounds.

Note - You can only use the *Load CSV* option if you are using a Trimble VX/S Series instrument and have the Trimble Survey Controller Engineering option (PN 90100-02, 90100-03) enabled on your controller.

5. When all observations are complete, Trimble Survey Controller software shows the *Standard deviations* screen.

6. If required, tap *Export* to save the rounds list as a CSV file for use at another time, or to share with another controller.

7. Tap *Close* to save and exit rounds.

Notes

- When using servo or robotic instruments, check that the instrument has sighted the target accurately. Manually adjust it if necessary. Some instruments can perform accurate sighting automatically. For information on the instrument specifications, refer to the instrument manufacturer's documentation.
- If you are using a servo or robotic instrument to measure a known (coordinated) point, tap *Turn*. Alternatively, with a servo instrument, set the *Servo auto turn* field in the survey style to *HA & VA*, or *HA only* to automatically turn the instrument to the point.
- If you tap *Esc* in the *Measure* screen, the current round is discarded.
- The top of the *Measure rounds* screen shows the following:
 - ◆ the current face observations
 - ◆ when you use more than one set per point, the number of the current set and the total number of sets to be measured (shown in brackets)
 - ◆ the number of the current round the total number of rounds to be measured (shown in brackets)

For example, "Face 1 (2/2) (1/3)" shows that the instrument is on face 1 of the second set of two sets and the first of three rounds.

Building the rounds list manually

When you manually build the rounds list, the Trimble Survey Controller software automatically adds each point to the internal rounds list as it is measured for the first time. The rounds list contains all the information about each point such as point name, code, target height, prism constant, and target ID.

To manually add a point to the rounds list, and then measure rounds:

1. Choose to include or exclude the backsight observation.
See also **Including/excluding the backsight**.

2. Follow the same procedure as for [measuring a topo point](#).

Note - To specify the prism constant or the height of the target for each observation in the rounds list, tap the target icon. If the prism constant is to be subtracted from measured distances, enter a negative value. You cannot alter the prism constant or the target height for subsequent rounds. Instead, Trimble Survey Controller uses those values stored when building the rounds list.

3. When the rounds list is built, tap *End Face*. The Trimble Survey Controller software:

- ◆ Defaults to the correct point details for each observed point.
- ◆ Directs you to change face when required. With a servo-driven instrument, this happens automatically.
- ◆ Automatically turns and measures when using Autolock and [Automated rounds](#) is enabled.
- ◆ Displays the results. You can then delete bad data as required.

Notes

- You cannot add the same point to the rounds list more than once. To take more measurements to points already measured, tap *End face*.
- You cannot edit the rounds list. Before you tap *End face*, be sure to observe all points to include in the rounds observations.

Building the rounds list from a CSV file

If you are using a Trimble VX/S Series instrument and have the Trimble Survey Controller Engineering option (PN 90100-02, 90100-03) enabled on your controller, you can load a rounds list from a CSV file instead of manually building the rounds list.

To *Load* a CSV file that contains all the points to include in the rounds, and then measure rounds:

1. Tap *Load* and select the CSV file that contains your [rounds list](#).
2. The points included in the CSV file appear, including coordinates and target details.

Note - If the backsight point was not included in the rounds file, it is automatically included in the rounds (only for a single backsight Station setup).

If you do not want the backsight point included in the rounds, delete the point from the list, or accept the rounds file and then select *Exclude*.

See also [Including/excluding the backsight](#).

Tip - To see the target details, tap and drag the scroll bar to the right.

Tip - To freeze the Point name column, tap and hold the Point name column heading. To unfreeze the column, tap and hold the heading again.

- ◆ To remove a point from the list, tap *Delete*. The point is removed only from this set of rounds - not from the CSV file or from the job.

- ◆ To add a point from the current job or a linked file to the end of the rounds list, tap *Add* and then key in the point name.
To view a list of points in the current job, or to key in, fast fix, or measure a point, tap the arrow on the *Point name* field and then select an option.
- ◆ To modify or enter new target details, tap *Target*.

To confirm the CSV file selection, tap *Accept*.

Note - If a target height is null (?) in automated rounds, the instrument will turn horizontally to the target.

If the instrument finds a target, it will measure and store an observation with a null target height. If it cannot find a target, and if *Skip obstructed targets* is enabled, it will move to the next target after 60 seconds.

If *Skip obstructed targets* is not enabled, a message appears after 60 seconds to indicate that the prism cannot be found. The Trimble Survey Controller software continues to try to measure to the target until it finds the target, or is instructed to skip the point. If the correct target height is entered, the instrument will automatically turn to the point and measure.

3. Tap *Measure* to start measuring. The Trimble Survey Controller software:

- ◆ Defaults to the correct point details for each observed point.
- ◆ Directs you to change face when required. With a servo-driven instrument, this happens automatically.
- ◆ Automatically turns and measures when using Autolock and *Automated rounds* is enabled.
- ◆ Displays the results. You can then delete bad data as required.

If you modified the rounds list and want to save a copy of the changes, select *Export* at the end of the round(s), when the rounds results appear.

To save a rounds list CSV file

If you intend to remeasure the same points at a later time, or on a different controller, you can save a rounds list to a CSV file.

To do this:

1. Manually measure and build the first rounds list. At the end of the round(s), the rounds results are displayed.
2. Tap *Export*, enter the *File name* and then tap *Accept*.

The rounds list is saved to the current project folder.

The rounds list is a comma delimited file and can contain the following information:

Field...	Contains...
1	Point name
2	First ordinate (Northing or Easting)
3	Second ordinate (Northing or Easting)
4	Elevation

5	Code
6	Description 1
7	Description 2
8	Target height and Measurement method
9	Target type or Prism constant
10	Target mode

Notes

- *Load* and *Export* functionality is available within rounds only if you are using a Trimble VX/S Series instrument and have the Trimble Survey Controller Engineering option (P/N 90100-02, 90100-03) enabled on your controller.
- When measuring a DR target with a Trimble VX/S Series instrument with automated rounds, the Trimble Survey Controller software will pause to allow you to sight to the target. You **must** manually sight and measure the point to continue.
- The rounds list **must contain** the first four fields. All other fields are optional. If fields 8 to 10 are null, then the details for the previous target are used.
- The Northing, Easting, Elevation, Target height, and Prism constant must be in the same units as the current job.
- The ordinate order of fields 1 and 2 is dependent on the *Coordinate order* configured for the current job.
- *Field 8*: The Measurement method controls whether the measurement is true vertical height or it is measured to the bottom notch on a Trimble prism base. All target heights are assumed to be true vertical, unless the target height has a 'b' suffix (bottom notch), for example, '1.23b'.
- *Field 9*: When you use a Trimble target, the prism name is shown in this field. When you use a Custom target, the prism constant is shown in this field. The following table shows the allowable prism types and the applicable prism constants:

Prism type	Prism constant
VXSSeriesMultiTrack	0.010
SSeries360Prism	0.002
SSeriesTraversePrism	-0.035
Small318mmTiltablePrism	0.000
Large635mmTiltablePrism	0.000
MiniPrism	-0.018
SuperPrism	0.000

- *Field 10*: The Target mode field may contain one of the following:

Field 10 options	Details
DR	<i>DR</i> on
AutolockOff	<i>Autolock</i> off
AutolockOn	<i>Autolock</i> on, <i>Target ID</i> off

a number between [1] and [8]	<i>Autolock</i> on always using the specified <i>Target ID</i>
FineLock	<i>FineLock</i> on

Include/exclude the backsight from a set of rounds

- If the station setup has a single backsight point (from station setup or station setup plus), you can choose to include or exclude the backsight point in the rounds list.
- If the station setup has multiple backsights (from station setup plus or resection), the backsight points are excluded from the rounds list.
- If you do not include the backsight point in your rounds, and export a rounds list, then the backsight point is not included in the rounds list file.
- Trimble recommends observing the backsight on both faces if you are taking foresight observations on both faces.

If you exclude the backsight:

- ◆ the backsight observation(s) taken during the station setup is used to compute the MTA.
- ◆ if you do not measure the backsight on face 2 and there is only one single face observation to the backsight, and the rounds include observations on both faces, then the horizontal angle face 2 measurements observed using *Measure rounds* will not be used when calculating the MTAs.

Rounds - maximum number

The following limits apply in rounds:

- rounds - maximum 100
- points per round - maximum 200
- sets per point within each round - maximum 10

Even though the maximum limits set in the Trimble Survey Controller software are generous, the limit on how many points you can observe depends on the memory available on the controller. For example, you could measure 100 rounds to 10 points, or 10 rounds to 200 points, but memory limits preclude measuring 100 rounds to 200 points.

For more details see:

- [Saving a rounds list](#)
- [Standard Deviations screen](#)
- [Point - Residuals screen](#)
- [Point details screen](#)
- [FineLock](#)
- [Face order](#)
- [Observation order](#)
- [Sets per point](#)
- [Number of rounds](#)
- [Skipping observations](#)
- [Automated rounds](#)

- **Monitoring**

Standard deviations screen

At the end of each round, the *Standard deviations* screen appears. This screen shows the Standard deviations of each point in the rounds list.

Do one of the following:

- To observe another round, tap + *Round*.
- To store the current rounds session, tap *Close*.
- To view/edit the Details of a point, highlight the point and then tap *Details*.
- To view or edit the residuals of each individual observation to a point, tap the point in the list once.
- To exit from rounds and delete all rounds observations, tap *Esc*.

Notes

- Each individual round is stored to the job only when you tap *Close* or + *Round* to exit the *Standard deviations* screen.
- To change the rounds configuration settings, tap *Options*.

Tips

- To highlight an item in a list, tap and hold the item for at least half a second.
- To sort a column in ascending or descending order, tap the column header. Tap the *Point* column header to sort the point in ascending or descending observed order.
- To change the residual display view, select an option from the drop-down list in the *Residuals* screen.

Point - Residuals screen

The *Point residuals* screen shows the differences between the mean observed position and the individual observations to a particular point.

Do one of the following:

- To disable an observation, highlight it and then tap *Use*.
- To view the details of an observation, highlight it and then tap *Details*.
- To return to the *Standard deviations* screen, tap *Back*.

Notes

- If you have measured face 1 and face 2 observations to a point, when you disable the observation for one face, the corresponding observation on the opposite face is automatically disabled.
- Whenever you make a change in the *Point residuals* screen, the mean observations, residuals, and standard deviations are recalculated.
- If the current station setup has a single backsight only, the *Use* softkey is not available for observations to the backsight. Observations to the backsight are used to orientate observations and cannot be deleted.

- If you remove observations, the  icon appears. If you skipped observations in a round, no icon appears.

Tip - If the residuals for an observation are high, it may be better to disable the observation from the round.

Point details screen

The *Point details* screen shows the mean observation details for a particular point.

FineLock

FineLock provides better performance when measuring to static targets in a rounds/monitoring application, especially when there are two prisms close together.

To use FineLock, enable the *Use FineLock* check box on the measure form within Rounds.

Notes on FineLock

- FineLock is available only on a Trimble S8 Total Station, within Rounds.
- FineLock can be used only to prisms more than 20 m away.
 - ◆ If FineLock is used and you measure a distance of less than 20 m, the Trimble Survey Controller software detects that FineLock should not be used, the measurement fails, and the message *Target too close for FineLock* appears. You must disable FineLock when measuring less than 20 m.
 - ◆ If FineLock is used to a target less than 20 m away, and a distance is not measured, the Trimble Survey Controller software uses FineLock because it cannot detect that FineLock should not be used.
 - ◆ Measurements taken with FineLock under 20 m are unreliable - do not use them.
- FineLock cannot be used at the same time as TRK, DR, or Autolock modes. FineLock always takes precedence over those modes.
 - ◆ If FineLock is enabled along with TRK, the observation is measured with STD mode.
 - ◆ If FineLock is enabled along with DR, the observation is measured with STD mode.
 - ◆ If FineLock is enabled when Autolock is already enabled, Autolock is automatically disabled. If you manually re-enable Autolock, it will be used to aim to the target, but FineLock will be used for the observation. If there are two prisms close together, do not enable Autolock at the same time as FineLock because Autolock may lock to the other prism before the FineLock observation is taken.
- FineLock cannot be used with *Averaged observations*.

Station setup plus, Resection, and Rounds Options

There are up to four main settings that control the order in which the observations are taken, and how many observations are made during Station setup plus, Resection, and Rounds:

- [Face order](#)
- [Observation order](#)
- [Sets per point](#)

- Number of rounds

Face order options

- *F1 only* - observations are taken only on face 1
- *F1... F2...* - all face 1 observations are taken to all points and then all face 2 observations are taken to all points
- *F1/F2...* - face 1 and then face 2 observations are taken to the first point, face 1 and then face 2 observations are taken to the next point, and so on

Observation order options

- *123.. 123*
- *123.. 321*

When the *Face order* is set to *F1... F2...* :

- *123.. 123* - observations on face 2 are taken in the same order as the observations on face 1
- *123.. 321* - observations on face 2 are taken in the reverse order to the observations on face 1

When the *Face order* is set to *F1 only* or *F1/F2* :

- *123.. 123* - each round of observations is taken in the same order
- *123.. 321* - every alternate round of observations is taken in the opposite order

Sets per point option

This option can be used to measure multiple sets of face 1 observations, or face 1 and face 2 observations to a point per round of observations.

If *Face order* is set to collect F1 and F2 observations, the *Sets per point* was set to 3, and the *Number of rounds* was set to 1, then the total number of observations to each point would be; $2 \times 3 \times 1 = 6$. Setting the *Sets per point* option to a number greater than 1 enables you to collect more than one set of observations to a point with only one visit to that location.

This option is currently available only in rounds.

Note - Before using this option please make sure this data collection technique matches your QA/QC requirements.

Number of rounds option

This option controls the number of complete rounds of observations that are taken to each point.

Skipping Observations

When using *Automate rounds* you can configure the software to automatically skip obstructed foresight targets.

If the instrument cannot measure the point and *Skip obstructed foresights* is **enabled**, it skips that point and moves onto the next point in the rounds list.

If the instrument cannot measure the point and *Skip obstructed foresights* is **disabled**, a message appears after 60 seconds to indicate that the prism is obstructed.

The Trimble Survey Controller software continues to try to measure to the target until instructed to skip the point. To do this, tap *Ok* for the obstructed prism message, tap *Pause* and then tap *Skip*.

When the Trimble Survey Controller software reaches the end of a rounds list in which points have been skipped, the following message appears:

Observe skipped points?

Tap *Yes* to observe the points that were skipped during that round. The observations can be skipped again if required. Tap *No* to end the round.

If a point is skipped in one round, all subsequent rounds continue to prompt for observations to that point.

When one observation from a pair of face 1 and face 2 observations has been skipped, the unused observation is automatically deleted by the Trimble Survey Controller software. Deleted observations are stored in the Trimble Survey Controller database and can be undeleted. Undeleted observations can be processed in the office software, but are not automatically used to recompute Mean Turned Angle (MTA) records in the Trimble Survey Controller software.

Backsight observations cannot be skipped using the *Skip obstructed foresights* option.

Automate rounds

The *Automate rounds* option is available for Trimble VX/S Series and 5600 instruments. When you select *Automate rounds*, the instrument automatically completes all rounds after the rounds list has been built.

If a target has been blocked, the instrument tries to measure the point for up to 60 seconds. After 60 seconds has elapsed it skips the observation and moves to the next point in the rounds list.

If you tap + *Round* after the instrument has completed the required number of rounds, the instrument performs one more round of observations. If you want the instrument to perform more than one extra round, enter the total number of required rounds **before** you tap + *Round*.

For example, to measure three rounds automatically, and then measure another three rounds:

1. Enter 3 in the *Number of rounds* field.
2. Once the instrument has measured 3 rounds, enter 6 in the *Number of rounds* field.
3. Tap + *Round*. The instrument measures the second group of 3 rounds.

Note - Manually observed targets are automatically paused.

Monitoring

When *Automated rounds* is enabled, monitoring controls are also enabled. Enter a value for the time delay between automated rounds.

With a Trimble 5600 instrument, you can automatically measure to non-active targets. To do this, select the *Auto-measure passive targets* check box.

Note - If you select the *Auto-measure passive targets* check box, manually observed targets are automatically measured rather than paused. If you clear this check box, the software prompts you to aim the instrument to non-active targets.

Continuous topo - Conventional

Use the *Continuous topo* function to measure points continuously.

A point is stored when one of the following conditions occurs:

- a predefined time has elapsed
- a predefined distance has been exceeded
- both predefined time and/or distance settings have been met
- a predefined stop time and distance settings have been met

To measure Continuous topo points:

1. From the main menu, select *Survey* and then perform a [station setup](#) , [station setup plus](#) , [resection](#) , or [refline](#).
2. From the main menu, select *Survey / Continuous topo*.
3. Enter a value in the *Start point name* field. This increments automatically.
4. Enter a value in the *Target height* field.
5. In the *Method* field, select *Fixed distance*, *Fixed time*, *Time and distance*, or *Time* or *Distance*.
6. Enter a value in the *Distance* field and/or the *Time interval* field, depending on which method you are using.
7. Tap *Start* to start recording data and then move along the feature to be surveyed.
8. To stop measuring continuous points, tap *End*.

Tip - To store a position before the predefined conditions have been met, tap *Store*.

Synchronous and non-synchronous angles and distances

Continuous topo with a Trimble VX/S Series instrument uses only synchronous angles and distances.

When using any other instrument with Continuous topo, for example a Trimble 5600 total station, the Trimble Survey Controller software uses the latest angles and the latest distance when it stores a position. When a synchronized angle and distance is not available (within approximately 1 second) a newer angle may be paired with an older distance. To minimize any potential position error, you may need to slow the prism movement during Continuous topo.

To measure Continuous topo points using the *Stop and go* method:

1. From the main menu, select *Survey* and then perform a [station setup](#) , [station setup plus](#) , [resection](#) , or [refline](#).
2. From the main menu, select *Survey / Continuous topo*.
3. Enter a value in the *Start point name* field. This increments automatically.
4. Enter a value in the *Target height* field.
5. In the *Method* field select *Stop and go*.
6. Enter a value in the *Stop time* field for the period of time the target must be stationary before the instrument starts to measure the point.

The user is deemed to be stationary when their velocity is less than 5 cm/sec.

7. Enter a value in the *Distance* field for the minimum distance between points.

When you use an instrument that has a tracklight that has been enabled, the tracklight will be disabled for 2 seconds when the measured point has been stored.

Scanning

Surface scanning is an automated direct reflex (DR) measuring process where measurements are automatically stored along a remote surface that you have defined.

Notes

- The Scanning option is available only when connected to a Trimble VX instrument.
- Scanning is not available when the Trimble Survey Controller software is connected through Bluetooth wireless technology.
- Scanning is not available when the Trimble Survey Controller software is connected through a serial cable connection.

For more details, see:



- [Starting a scan](#)
- [Progress information](#)
- [Ending a scan](#)
- [White balance](#)

Starting a scan



To perform a scan using Trimble Survey Controller:

1. From the main menu, select *Survey* and then perform a [station setup](#) , [station setup plus](#) , [resection](#) , or [refline](#).
2. From the *Survey* menu, select *Scanning*.
3. Define the area for the scan. Use one of the following methods, and see below for preset buttons that you can use.

Polygon framing:

1. If  is displayed, tap  to set the Polygon framing mode.
2. Tap on the video screen to define the first corner of the polygon.
3. Tap again on the video screen to define the second vertex. You must enter at least three vertices to define a polygon scan frame.
4. If required, drag-and-drop the last vertex to move it, or select the vertex and then tap undo () to remove it. You can do this only with the last vertex.

Rectangular framing:

1. If  is displayed, tap  to set the Rectangular framing mode.
2. Tap on the video screen to define the first corner of the scan rectangle.
3. Tap again on the video screen to define the opposite corner of the scan area.
4. If required, drag-and-drop the vertices, or click and drag the sides of the scan frame to resize the scan rectangle.
4. Define the point density for the scan area:
 1. Tap scan properties ().
 2. Define the scan properties. Select one of the following methods:
 - ◇ Horizontal and vertical distance interval at a given distance
 - ◇ Horizontal and vertical angle interval
 - ◇ Total number of points in the scan
 - ◇ Time to complete
 3. Enter the parameters to define the scan density.
5. Tap *Start*.





Notes

- The camera is not coaxial with the telescope. For accurate framing at close range, define the *At distance* setting, which helps to draw the scanning frame in the correct position.
- The time to complete a scan is an estimate only. Actual scan times will vary depending on the surface or object being scanned.
- Scan time is increased if there are areas within the scan that will not return an EDM signal. Where possible, try to minimise blank space in the scan area.
- Defining the scanning grid through distance intervals assumes that the scanning object is a constant distance from the instrument. In other cases, the scan points will not constitute an even grid.
- When you perform a scan with the Trimble VX through a robotic connection, Trimble recommends that you stay within the range of the radio link to ensure that all necessary data is collected successfully. If you lose the radio link, the remainder of the current scan line will be skipped.
- You can scan a full 360° horizontally. The vertical range is approximately between 3°36' (4 gon) and 150° (166 gon).







You can use the preset buttons to help you define the scan area.

These preset buttons are available for Polygon framing:



Softkey	Function
---------	----------





	Toggles between rectangular and polygon framing mode.
	When selected, the polygon framed area is shaded red.
	Deletes the scan frame from the screen. When the 'cross' is grey, the delete function is not available.
	Undoes the previous vertex. When the 'arrow' is grey, the undo function is not available.

These preset buttons available for Rectangular framing:

Softkey	Function
	Toggles between rectangular and polygon framing mode.
	Toggles between the current frame and the complement of the current frame. Tap this button to change the horizontal extents of the scan so that the horizontal scan area is the opposite of the original frame; it is the larger part of the horizontal circle. The vertical extents of the scan area do not change.
	Toggles between the current frame and the complement of the current frame. Tap this button to change the horizontal extents of the scan so that the horizontal scan area is the original frame; it is the smaller part of the horizontal circle. The vertical extents of the scan area do not change.
	Automatically defines a rectangle from the highest to lowest vertical angles in the current horizontal position. To resize the scan frame, drag one of its sides or vertices. This is useful for quick-framing an object (for example, a facade), in front of the instrument.
	Automatically defines a large horizontal rectangle through the majority of the horizontal circle. To resize the scan frame, drag one of its sides or vertices. This is useful for quick-framing an object that surrounds the instrument.
	Deletes the scan frame from the screen. When the 'cross' is grey, the delete function is not available.
	Undoes the previous vertex. When the 'arrow' is grey, the undo function is not available.

You can capture the image displayed in the video frame of the scanning window.

Softkey	Function
	Links to the <i>Scan Properties</i> form where you can define the parameters of the scan. You can define the density of scan points within the frame area by distance intervals, angle intervals, the total number of points, or the scan time.
	Controls the brightness of the video image on the controller screen and consequent captured images.
	Controls the contrast of the video image on the controller screen and consequent captured images.
	Controls the level of white balance in the video image on the controller screen and consequent captured images.
	Set the file name. File names are automatically incremented from the start file name.
	Set the image size. The image captured is always the same as the video display on screen. Not all image sizes are available at all zoom levels.
	Set the compression of the image. The higher the quality of the image, the larger the file size of the captured image.

	Captures an extra large (XL) image (2048x1536). XL is available only when zoomed to extents 1:1.
	Captures a large (L) image (1024x768). L is available only when zoomed out to extents 1:1 and 2:1.
	Captures a medium (M) image (512x384). M is available only when zoomed in to 1:1, 2:1, and 4:1.
	Captures a small (S) image (256x192). S is available regardless of the zoom level.
	Launches the <i>Panorama</i> function where you can automatically capture multiple images for a defined scan frame. Define the <i>Image size</i> and <i>Compression</i> , enable <i>Fixed exposure</i> to fix the exposure to the settings at the time you tap <i>Start</i> , define the <i>Image overlap</i> and then tap <i>Start</i> to begin taking the images.

Tip - The exposure is fixed when you select *Start*. When using the *Panorama* function with *Fixed exposure* enabled, point the Trimble VX to the location that defines the camera exposure that you want used for all panoramic images and then tap *Start*.

You can navigate/zoom around the video frame in the scanning window. The navigation controls are as follows.

Softkey	Function
+	Zoom in. There are four levels of zoom available in the video window.
-	Zoom out. There are four levels of zoom available in the video window.
<i>Pan</i>	Activate tap-and-move functionality in the video window.
	Zoom out to the full extents.
<i>Options</i>	<i>Display point clouds</i> controls the option to display the point cloud over the scan.
	<i>Color</i> controls the color of the point cloud.
	<i>Point size</i> controls the width of the pixel displayed in the point cloud.

Point cloud color

Color	Show points...
Cloud color	with the color of the clouds they belong to
Station color	with the color of the stations they belong to
Scan color	with the color of the scans they belong to
Grey scale intensity	using the gray scale defined by their intensity
Color coded intensity	using the color encoded intensity

Progress information

During a scan, progress information appears in the scanning window. For every point in the scan, a colored square appears on screen.

- The color of the square indicates the measured distance to the point. A nearby point is red, compared to a point further away which is blue.
- The brightness of the square indicates the intensity of the returned EDM signal. The brighter the square, the better (more intense) the signal.

- A black square indicates that no measurement was able to be taken at that location.
- The size of the squares depends upon the number of points in the scan. The smaller the square, the more points in the scan. When the scan is completed, the points will cover the maximum possible area; so a tall, narrow scan area, that does not fit the screen size well, appears with black strips on each side of the drawn scan points.

The status line is updated after each line of the scan has completed. It provides progress information on:

- The percentage of scan completed.
- The number of points scanned.
- The estimated time remaining. This is updated as the scan progresses to reflect the current scan speed and is dependant on the surface of the object in the scan.

While a scan is in progress:

- You cannot edit scan properties. To view the properties, tap the scan properties button.
- Other instrument/survey functions are disabled. If you need to access a survey or instrument function during a scan, you must pause the scan, perform the operation and then continue the scan.
- You cannot access the video window. You must first complete the scan and then close the scanning window.

Ending a scan

When the scan is completed, the *Pause / Continue* softkey changes to *Finish*. Tap *Finish* or *Esc* to end the scan.

To cancel a scan that is in progress, tap *Esc* and then tap *yes*. The scanning record and associated TSF file will still be written if you manually cancel a scan.

Notes

- Scanned points are not stored in the Trimble Survey Controller job file; they are written to a TSF file that is stored in the current [project folder](#).
- You can import the Trimble Survey Controller JOB or JXL file into the Trimble RealWorks Survey software. If associated TSF and JPEG files are stored in the same [project folder](#) as the JOB or JXL file, they are imported at the same time.
- To transfer JPEG files from the Trimble CU in the docking station to the office computer, use the USB-to-Hirose cable.
You cannot use the DB9-to-Hirose serial cable to transfer JPEG files.
- Once the scan is completed, the name of the scan file, and the scan properties, are stored in the Trimble Survey Controller job file.

Tips

- When a scan is completed or cancelled, the last used frame area is retained in the scanning video window. To rescan the same area, edit the scan properties (if required) and then tap *Start*.

Surface Scan

Surface scanning is an automated direct reflex (DR) measuring process where measurements are automatically stored along a remote surface that you have defined.

The Surface scan option is not available when connected to a Trimble VX instrument. Use [Scanning](#) when connected to a Trimble VX instrument.

To perform a surface scan using Trimble Survey Controller:

1. From the main menu, select *Survey* and then perform a [station setup](#) , [station setup plus](#) , [resection](#) , or [refline](#).
2. From the *Survey* menu, select *Surface scan*.
3. Enter the *Start point name* and *code* (if necessary).
4. In the *Method* field, select a measurement method.
5. Define the area for the scan and grid interval.
6. Tap the Trimble functions button and set the EDM measurement method (TRK is fastest).

The total number of points to scan, scan grid dimensions, and estimated scan time are displayed. Change the scan size, step sizes or EDM measurement method to increase or decrease the number of points and scan time.

7. Tap *Start*.

To define the scan area, do one of the following:

- If the point already exists, enter the point name, or use menu arrow to select it from the list.
- From the pop-up menu in the *Top left* and *Bottom right* fields select *Fast fix* or *Measure* to measure and store points that define the limits of the search.

Define the scan area with one of the following methods.

HA VA interval - Use this method on complex surfaces when you cannot use a rectangular plane to approximate the surface you are scanning (see the following diagram):

1. Aim to the top left corner of the scan area (1) and measure a point.
2. Aim to the bottom right corner of the scan area (2) and measure another point.
3. Define the angular grid interval, where:
 - 3 is the Horizontal angle
 - 4 is the Vertical angle

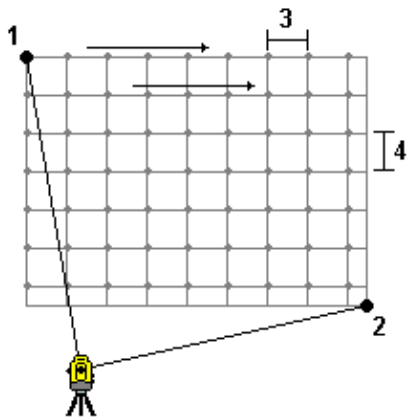

Tip - To define a Horizontal only scan of a 360° scan area, set the Top left and Bottom right points to the same name, and set the VA interval to null.

Rectangular plane - Use this method on a plane surface where you need a regular grid interval. Trimble Survey Controller determines the angle of the plane, and uses this and the grid interval to approximate how far to turn the instrument for each subsequent point (see the following diagram):

1. Aim to the first corner of the scan area (1) and measure a point.
2. Aim to the second corner of the scan area (2) and measure another point.
3. Aim to the third point on the opposite side of the plane (3) and measure a point.
4. Define the distance grid interval, where:
 - 4 is the Horizontal distance
 - 5 is the Vertical distance

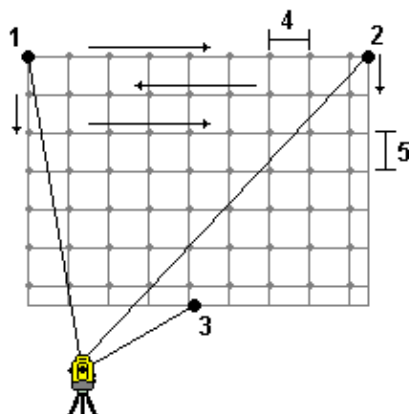

Line and offset - Use this method to define the area to scan from a center line that has equal offsets to the left and right. Trimble Survey Controller defines the surface using horizontal offsets perpendicular to the center line. The software then uses this definition and the station interval to determine approximately how far to turn the instrument for each subsequent point (see the following diagram):

1. Do one of the following:

- Two point method:

1. Aim to the start point of the center line (1) and measure a point.
2. Aim to the end point of the center line (2) and measure another point. These two points (1 and 2) define the center line.

- Access the pop-up menu in the *Start point* field. Change the method and then define the line by a start point with azimuth and length.

2. Define the station interval (3).
3. Define the maximum offset distance (4).
4. Define the offset interval (5).

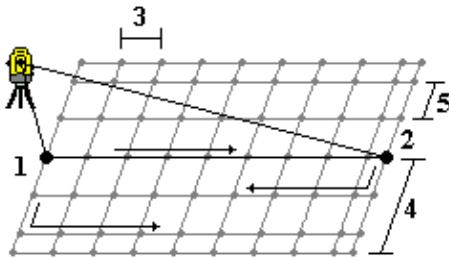

Trimble Survey Controller scans the center line first, then the points on the right-hand side, and finally the left-hand side.

Note - With all of the above methods, the defined scan area may not exactly fit the grid interval. There may be an area left over along the scan extents that is smaller than the grid interval. If the width of this area is less than one-fifth of the grid interval, the points along this scan area will not be measured. If the width is more than one-fifth of the grid interval, then an extra point is scanned.

Station and offset

The *Station and Offset* option is available for both GPS and Conventional surveys enabling points to be measured or staked out relative to a line or arc.

1. Select *Survey / Station and offset* from the Trimble Survey Controller main menu.
2. Select *Measure* or *Stakeout*.
3. In the *Type* field of the *Station and offset* screen, select the arc or line relative to which you want to measure or stake out.

4. Tap *Enter*. The appropriate stakeout screens appear as follows:

- Select *Station and Offset / Measure relative to a line*. The *Stakeout line* screen appears and the stakeout method is set to *To the line*.
- Select *Station and Offset / Measure relative to an arc*. The *Stakeout line* screen appears and the stakeout method is set to *To the arc*.
- Select *Station and Offset / Stakeout relative to a line*. The *Stakeout line* screen appears and the stakeout method is set to *Station/Offset from line*.
- Select *Station and Offset / Stakeout relative to an arc*. The *Stakeout arc* screen appears and the stakeout method is set to *Station/offset from arc*.

Averaged Observations

In a conventional survey, use the Averaged observations method to:

- increase the measurement precision with a predefined number of observations
- view the associated measurement standard deviations

To measure a point using the Averaged observations method:

1. From the main menu, select *Survey* and then perform a *station setup* , *station setup plus* , *resection* , or *refline*.
2. From the *Survey* menu, select *Measure topo*.
3. In the *Point name* field, enter the name of the point.
4. In the *Code* field, enter a feature code (optional).
5. Select *Averaged observations* as the method.
6. Sight the target and tap *Measure*.
While the instrument is carrying out the measurements, standard deviations are displayed for the horizontal (HA) and vertical (VA) angles, and the slope distance (SD).
7. View the resulting observation data, and the associated standard deviations, in the *Store* screen.
If acceptable, tap *Store*.

Note - Use the options available in the *Measure topo* screen to change the number of observations taken by the instrument using averaged observations.

Angle Offset, H. Angle Offset, and V. Angle Offset

In a conventional survey, there are three angle offset methods that you can use to observe a point that is inaccessible; Angle offset, H. Angle offset, and V. Angle offset.

The *Angle offset* method holds the horizontal distance from the first observation, and combines this with the horizontal angle and vertical angle from the second observation to create an observation to the offset location.

The *V.Angle offset* method holds the horizontal distance and horizontal angle from the first observation, and combines this with the vertical angle from the second observation to create an observation to the offset

location.

The *H.Angle offset* method holds the slope distance and vertical angle from the first observation, and combines this with the horizontal angle from the second observation to create an observation to the offset location.

All raw observables from the first and second observations are stored internally in the job file and are available in Custom ASCII Export.

To measure a point using one of the Offset methods:

1. From the main menu, select *Survey* and then perform a [station setup](#) , [station setup plus](#) , [resection](#) , or [refline](#).
2. From the *Survey* menu, select *Measure topo*.
3. In the *Point name* field, enter the name of the point.
4. In the *Code* field, enter a feature code (optional).
5. In the *Method* field, select *Angle offset*, *H. Angle Offset*, or *V. Angle Offset*.
6. You do not need to enter the *Target height*. The offset measurements are to the offset location and the target height is not used in any computations. To ensure that a target height is not applied to the observation, a target height of 0 (zero) is automatically stored to the Trimble Survey Controller software database.
7. Place the target beside the object to be measured, sight the target and then tap *Measure*.

The first observation is displayed.

8. Turn to the offset location and then tap *Measure*. The two observations are combined into one:
 - if you selected the [View before storage](#) check box in the survey style, the measurement values appear. Tap *Store* to store the point.
 - if you did not select the [View before storage](#) check box, the point is stored automatically.

Note - The observation is stored in the database as raw HA, VA, and SD records.

Distance Offset

In a conventional survey, use this observation method when a point is inaccessible but a horizontal distance from the target point to the object can be measured.

Distance offset allows you to offset in one, two, or three distances in one step.

To measure a point using the *Distance offset* method:

1. From the main menu, select *Survey* and then perform a [station setup](#) , [station setup plus](#) , [resection](#) , or [refline](#).
2. From the *Survey* menu, select *Measure topo*.
3. In the *Point name* field, enter the name of the point.

4. In the *Code* field, enter a feature code (optional).
5. In the *Method* field, select *Distance offset*.
6. In the *Target height* field, enter the height of the target.
7. Tap *Options*, and set the *Offset directions* perspective.
8. Enter the *L/R offset* (left or right offset) from the target to the object, if applicable.
9. Enter the *In/Out offset* from the target to the object, if applicable.
10. Enter the *V.Dist offset* from the target to the object, if applicable.

Refer to the following diagram for an example where point 5 is measured with the *Offset directions* set to *Instrument perspective* :

- ◆ offset to the left (2) of the target (3)
- ◆ offset out (4) from the instrument station (1)
- ◆ offset vertically (6)

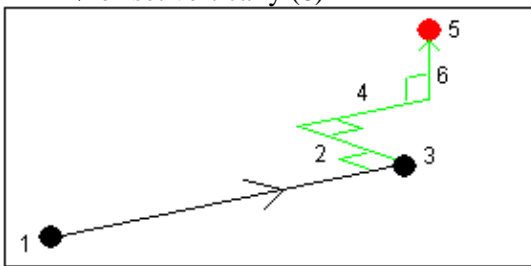

11. Tap *Measure*.

If you selected the *View before storage* check box in the survey style, the observation adjusted for the offset distance appears. Tap *Store* to store the point.

If you did not select the *View before storage* check box, the point is stored automatically.

The Trimble Survey Controller software stores the adjusted horizontal angle, vertical angle, and slope distance in the point record, as well as an offset record with the offset measurement details.

Offset directions

The left and right directions used in *Distance offset* are dependant on the *Offset directions* setting. This setting can be configured from *Options*.

When looking from the instrument to the object, an object that is offset to the left when the *Offset directions* is set to *Instrument perspective* will be to the left, but when the *Offset directions* is set to *Target perspective* it will be to the right.

When the *Offset directions* is set to *Automatic* the offset directions will be with respect to the instrument perspective in a Servo survey, and target perspective in a Robotic survey.

The measurements are editable in *Review current job* and are always displayed in the perspective in which they were observed. The perspective cannot be changed in review. The measurement is always stored relative to the instrument position.

Dual-prism Offset

In a conventional survey, use this measurement method to coordinate a point that cannot be observed directly with a pole in a plumb position.

To measure a point using the dual-prism offset method:

1. As shown in the following diagram, space two prisms (A and B) apart on the range pole. The distance BC is known.
1. From the main menu, select *Survey* and then perform a [station setup](#) , [station setup plus](#) , [resection](#) , or [refline](#).
2. From the *Survey* menu, select *Measure topo*.
3. In the *Point name* field, enter the name of the point.
4. In the *Code* field, enter a feature code (optional).
5. In the *Method* field, select *Dual-prism offset*.
6. Complete the fields as required.
7. Take two measurements (tap *Measure*).

The Trimble Survey Controller software calculates the obscured position (C) and then stores it as a raw HA VA SD observation.

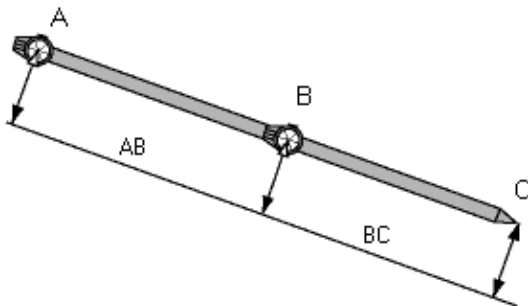

All raw observations are stored internally in the job file and are available in Custom ASCII Export.

Circular object

In a conventional survey, use this measurement method to calculate the center point of a circular object, such as a water tank or silo. To do this:

1. From the main menu, select *Survey* and then perform a [station setup](#) , [station setup plus](#) , [resection](#) , or [refline](#).
2. From the *Survey* menu, select *Measure topo*.
3. Use the *Circular object* method to measure an angle and distance to the front center face of the circular object.
4. Observe an angles only measurement to the side of the circular object.

From these two measurements Trimble Survey Controller calculates the center point of the circular object and stores it as a raw HA VA SD observation. The radius is also calculated and stored as a note.

Remote Object

In a conventional survey, if the instrument does not support DR mode, or if you cannot measure a distance, use this method to calculate the height and/or width of a remote object. See the following diagram.

1. Start a conventional survey.
2. Select *Measure Topo / Remote object*.
3. Measure an angle and distance to the bottom of the remote object (1).
4. Set the method as required.
5. Sight to the Remote point (2).
6. Tap *Store* to store the observation.
7. To make multiple remote object observations, repeat steps 5 and 6.

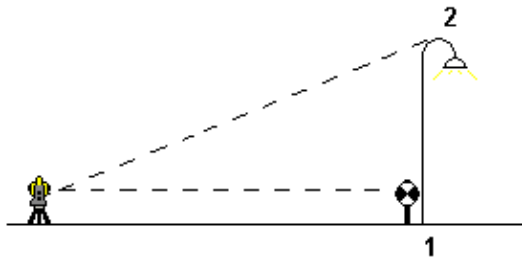

Using the first measurement and continuous HA VA angles, Trimble Survey Controller calculates the position of the remote object, showing the width and elevation difference from the base point. The observation to the base of the remote object is stored as an HA, VA, SD. The Remote point is stored as an HA, VA with a computed SD, including the Object height and Object width.

Conventional Instrument - Corrections

You can set the corrections associated with conventional observations.

Note - If you intend to perform a network adjustment in the Trimble Geomatics Office software using data from a conventional survey, make sure that you enter a pressure, temperature and, curvature and refraction correction.

Use the *PPM* (Parts Per Million) field to specify a PPM correction to be applied to electronic distance measurements. Key in the PPM correction, or enter the pressure and temperature of the surrounding environment and let the Trimble Survey Controller software compute the correction.

Note - If you are using a Trimble VX/S Series instrument, the pressure field is set automatically from the sensor in the instrument. To disable this, tap the advanced pop-up arrow and then clear the *From instrument* check box.

Use the *Curvature and refraction* field to specify the index of refraction value. This is used to compute the curvature and refraction correction that is applied to vertical angle observations. See the following table for a description of the curvature and refraction options.

Option	Description
0.142	for use during the day
0.2	for use at night
None	no correction applied

Note - Do not set corrections in both devices. To set them in the Trimble Survey Controller software, make sure the instrument settings are null.

For some instruments, the Trimble Survey Controller software automatically checks to see if various corrections (PPM, prism constant, and curvature and refraction) are being applied correctly. If it finds that the corrections are being applied twice, a warning message appears.

In the following table, the * symbol in a field indicates that the correction at the top of that column is applied.

Note - '*' applies only to computed coordinates when a station setup has been defined.

Displayed / Stored data	Corrections applied										
	C+R	PPM	PC	SL	Orient	Inst ht	Tar ht	Proj Cor	Stn SF	NA	POC
Status line	-	-	-	-	-	-	-	-	-	-	-
HA VA SD (raw)	-	-	-	-	-	-	-	-	-	-	*
HA VA SD	*	*	*	-	-	-	-	-	-	-	*
Az VA SD	*	*	*	-	*	-	-	-	-	-	*
Az HD VD	*	*	*	-	*	*	*	*	*	-	*
HA HD VD	*	*	*	-	-	*	*	*	*	-	*
Grid	*	*	*	*	*	*	*	*	*	*	*
delta Grid	*	*	*	*	*	*	*	*	*	*	*
Station and offset	*	*	*	*	*	*	*	*	*	*	*
DC file (observations)	-	-	-	-	-	-	-	-	-	-	*
DC file (reduced coordinates)	*	*	*	*	*	*	*	*	*	*	*
JobXML (observations)	-	-	-	-	-	-	-	-	-	-	*
JobXML (reduced coordinates)	*	*	*	*	*	*	*	*	*	*	*
SC Basic	*	*	*	*	*	*	*	*	*	*	*

The following table explains the corrections used above.

C+R	Curvature and Refraction correction.
PPM	Atmospheric Parts Per Million correction - PPM is calculated from temperature and pressure.
PC	Prism constant correction.
SL	Sea level (ellipsoid) correction. - this correction is applied only if a fully defined coordinate system definition is being used; the correction is not applied in the <i>Scale factor only</i> definition.
Orient	Orientation correction.
Inst ht	Instrument height correction.
Tar ht	Target height correction.
Proj Cor	Projection correction. - this includes the application of a scale factor specified in the <i>Scale factor only</i> definition.
Stn SF	Station setup scale factor. - in any station setup, a scale factor for this setup can be specified or computed. This scale factor is applied in the reduction of all observations from this station setup.
NA	Neighborhood adjustment. - in a station setup defined using <i>Station setup plus</i> or <i>Resection</i> , a neighborhood adjustment can be applied. The neighborhood adjustment is computed based on the observed residuals to the control points used during the station setup. The adjustment is applied, using the specified exponent value, in the reduction of all observations from this station setup.
POC	Prism offset correction - only applied when using a Trimble 360° prism or a Trimble MultiTrack target.

Target Details

You can configure the details of the target during a conventional survey.

When connected to a conventional instrument the Target icon appears in the status bar. The number next to the target icon indicates the target currently in use. To alternate between targets or to edit the target height and the [prism constant](#), tap the target icon. To select the target to use, tap the appropriate target in the pop-up list. You can create up to five non-DR targets.

Tip - To change to a target, select the target name. To edit entries in the *Target* form, select the target height or prism constant.

Note - If you are using a Trimble VX/S Series instrument, the *Pressure* field is set automatically from the sensor in the instrument. To disable this, tap the advanced pop-up arrow and then clear the *From instrument* check box.

When connected to a DR instrument, Target DR is used to define the DR target height and prism constant. To enable DR, select Target DR. To disable DR and return the instrument to its last state, select target 1 - 5.

When measuring to the bottom notch on a Trimble prism base, tap the advanced pop-up arrow () and then select *Bottom notch*.

Trimble Survey Controller corrects this measured slope value to true vertical and adds the offset 0.158 m (0.518 sft) to calculate the true vertical height to the center of the prism.

Note - If you select *Bottom notch*, the minimum slope distance (Hm) that you can enter is 0.300 meters. This is approximately the minimum slope distance that can be physically measured. If this minimum is too low, you must measure to the top mark.

For information on configuring an integrated survey rover survey rod see, [Integrated Surveys](#).

For details, see the following figure and table.

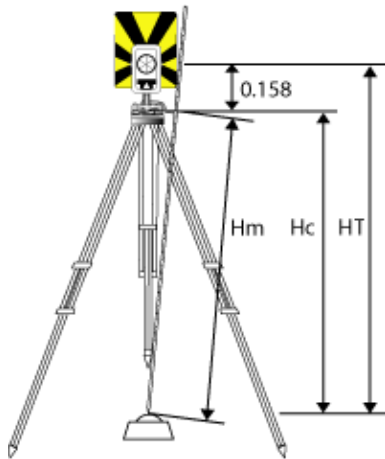

0.158m	Offset from bottom notch to center of prism.
Hm	Measured slope distance.
Hc	Hm corrected from slope to true vertical.
HT	True vertical target height. Hc + 0.158m.

To add a new target:

1. Tap the target icon in the status bar and then tap the height or prism constant for Target 1.
2. In the *Target 1* screen, tap *Add* to create Target 2.
3. Enter the details for *Target 2* and then tap *Accept*.
4. Target 2 now becomes the active target.

To delete a target from the list:

1. Tap the target icon in the status bar and then tap the height or prism constant.
2. In the *Target* screen, tap *Delete*. The Target is removed from the list.

Note - You can not delete Target 1 or Target DR.

To edit a target height:

1. Tap the target icon in the status bar.

2. Tap the target height for the target you want to edit.
3. Edit the target details and then tap *Accept*.

To edit target heights of observations already stored to the job, do one of the following:

- For a single observation or multiple observations using the same or different targets, use [Point Manager](#).
- For a single target record, and subsequently a group of observations that use that target, use [Review current job](#).

Target tracking with the Trimble VX/S Series

If you use a Trimble VX/S Series instrument with search capabilities and a Trimble VX/S Series 360° prism or a Trimble MultiTrack target, you can configure the software to use an Active Target ID.

Note - If you use a Trimble VX/S Series instrument with the Trimble MultiTrack target, you must upgrade the instrument to firmware version R7.0.35 or later. The Trimble VX/S Series firmware is available on www.trimble.com.

- When using the Trimble MultiTrack target, the **Tracking mode** can be set to *Passive* or *Active*. When the tracking mode is set to *Active*, you can configure the Target ID.
- When using the Trimble VX/S Series 360° prism, the **Target ID** can be set to *Off*, *Search*, *Search and measure*, or *Always*. When the tracking mode is set to *Search*, *Search and measure*, or *Always*, you can configure the Target ID.

From the following, select the target ID checking method that best suits the equipment you have and the environment that you are working in:

- [Active](#) - the instrument is always locked to the active target.
- [Search](#) - check the ID when a search is initiated.
- [Search and measure](#) - check the ID when a search is initiated, and when a measurement is initiated.
- [Always](#) - the ID is constantly being checked by the instrument.

Tracking mode - Active

- If you operate in a highly reflective environment, or on a site with many prisms, set the *Tracking mode* to *Active* to ensure that you maintain constant lock to the correct target.

To do this:

1. Tap the target icon on the status bar.
2. Do one of the following:

- If available, select the *Target ID* field.
The *Target ID* field is available only when you use a Trimble MultiTrack target, and *Tracking mode* is set to *Active*.
- Select the *Target height* or *Prism constant* field to open the *Target* form.

3. Set the *Prism type* to VX/S Series MultiTrack.
4. Set the *Tracking mode* to Active.
5. Set the *Target ID* to match the identification number in the Target ID on the robotic rover.

Check the target ID - Search

If you operate in an environment with few reflective surfaces, but you want to ensure that if you do a search you will lock to the correct target, set *Check target ID* to *Search*.

To do this:

1. Tap the target icon on the status bar.
2. Do one of the following:
 - If available, select the *Target ID* field.
The *Target ID* field is available only when you use an VX/S Series 360° prism, and *Check target ID* is not set to Off.
 - Select the *Target height* or *Prism constant* field to open the *Target* form.
3. Set the *Prism type* to VX/S Series 360°.
4. Set the *Check target ID* to Search.
5. Set the *Target ID* to match the identification number in the Target ID on the Trimble Standard Rod.

Check the target ID - Search and measure

If you operate in an environment with few reflective surfaces, but you want additional assurance if you do a search or when you measure that you will lock to the correct target, set *Check target ID* to *Search and measure*.

To do this:

1. Tap the target icon on the status bar.
2. Do one of the following:
 - If available, select the *Target ID* field.
The *Target ID* field is available only when you use an VX/S Series 360° prism, and *Check target ID* is not set to Off.
 - Select the *Target height* or *Prism constant* field to open the *Target* form.
3. Set the *Prism type* to VX/S Series 360°.
4. Set the *Check target ID* to Search and measure.
5. Set the *Target ID* to match the identification number set in the Target ID on the Trimble Standard Rod.

Check the target ID - Always

If you operate in a highly reflective environment, or on a site with many prisms, set *Check target ID* to *Always* to ensure that you maintain constant lock to the correct target.

To do this:

1. Tap the target icon on the status bar.
2. Do one of the following:
 - If available, select the *Target ID* field.
The *Target ID* field is available only when you use an VX/S Series 360° prism, and *Check target ID* is not set to Off.
 - Select the *Target height* or *Prism constant* field to open the *Target* form.
3. Set the *Prism type* to VX/S Series 360°.
4. Set the *Check target ID* to Always.
5. Set the *Target ID* to match the identification number in the Target ID on the robotic rover.

For more information on the different *Check target ID* modes, see [Target ID - Target tracking with Trimble VX/S Series](#).

Remote Measuring Target (RMT) ID - Target tracking with Trimble 5600

When you work on a site with multiple RMTs, configure the RMT channel ID to lock onto a specific RMT target.

This is only available on supported instruments.

To do this:

1. Tap the target icon on the status bar.
2. Select the *Target ID* field to open the *Target* screen.
3. Set the RMT ID in the Trimble Survey Controller software to match the ID set in the RMT. For more information, refer to the *Trimble 5600 Series User Guide*.

Tip - To lock to RMTs that do not support RMT ID, set the RMT ID to 4.

Prism Constant

The prism constant (distance offset) must be set for each prism that is used as a target in a conventional survey.

To edit a prism constant:

1. Tap the target icon in the status bar.
2. Tap the prism constant for the target you want to edit.
3. Edit the prism constant details and then tap *Accept*.
Enter a negative value if the prism constant is to be subtracted from measured distances. Enter the Prism constant in millimeters (mm).

When using a Trimble VX/S Series, 5600, or 3600 instrument, all corrections are applied in Trimble Survey

Controller.

For some non-Trimble instruments, the Trimble Survey Controller software checks to see if a prism constant has been applied by the instrument **and** the software. When you select *Station setup*, status line messages show what has or has not been checked.

If the Trimble Survey Controller software cannot check the setting on the conventional instrument, do one of the following:

- If there is a prism constant set on the instrument, make sure that the prism constant in the Trimble Survey Controller software is set to 0.000.
- If there is a prism constant set in the Trimble Survey Controller software, make sure that the prism constant in the instrument is set to 0.000.

To review or edit the prism constant on previously stored observations, tap *Favorites / Review current job* or *tap Files / Point manager*. For more information, see [Point Manager](#).

Measuring a Point in Two Faces

To start a conventional survey in the Trimble Survey Controller software, you must first perform a *Station setup* using one of the following methods:

- [Station setup](#)
- [Station setup plus](#)
- [Resection](#)
- [Reflines](#)

You can observe points using face 1 (direct) and face 2 (reverse) measurements during a station setup and during [Measure rounds](#) or [Measure topo](#).

Consider the station setup and the new point measurement method together and choose which to use according to how you want to capture and store the data.

If you only want to use a single backsight (measured on one or both faces), and measure some topo points (on one or both faces), then use *Station setup* and *Measure topo*. When you measure on both faces, remember to also measure the backsight on face 2 in *Measure topo*. Otherwise, all foresights on face 2 will be oriented using the face 1 backsight observation.

If you want to measure multiple backsights, measure multiple rounds, or obtain better quality control of your observations, see below for more information on different station setup and new point measurement methods in Trimble Survey Controller.

Use **Station setup plus** to:

- measure a single backsight point or multiple backsight points
- measure backsight and foresight points

- pair the face 1 and face 2 observations and create MTA records
- measure face 1 only observations and create MTA records
- measure one or more rounds of observations
- review the quality of the observations and remove bad observations

Use **Resection** to:

- coordinate the instrument point
- measure multiple backsight points
- measure backsight and foresight points
- pair the face 1 and face 2 observations and create MTA records
- measure face 1 only observations and create MTA records
- measure one or more rounds of observations
- review the quality of the observations and remove bad observations

Use **Station setup** to:

- perform a station setup with a single backsight measurement on one face only

Notes

- When measuring points on both faces, use *Measure topo* to observe the backsight on the other face. Alternatively, use *Measure rounds* and include the observation to the backsight point in the rounds.
- When you make topo observations after a *Station setup*, and you subsequently select *Measure rounds*, you must reobserve the backsight to include it in the rounds, generate an MTA to the backsight, and calculate turned angles from the backsight MTA for all foresight points.
- MTAs are not created during *Station setup*, but are created later if you make further observations to the backsight using *Measure topo* or *Measure rounds*.

Use **Measure rounds** (after performing a station setup) to:

- measure one or more foresight points
- pair the face 1 and face 2 observations and create MTA records
- measure face 1 only observations and create MTA records
- measure one or more [sets of observations per point](#) in one round
- measure one or more rounds of observations
- review the standard deviations of the observations and remove bad observations

Notes

- Standard deviations are only available after the second round of observations.
- If the station setup has a single backsight (from *Station setup* or *Station setup plus*), you can choose whether or not to include the backsight point in the rounds list.
- If the station setup has multiple backsights (from *Station setup plus* or *Resection*), the backsight points are not included in the rounds list.
- If you do not measure the backsight on face 2, then the horizontal angle face 2 measurements that were observed using *Measure rounds* will not be used when calculating the MTAs.

- When you use *Measure rounds* after a station setup with a single backsight, and you do not include the backsight point in the rounds list, all turned angles are calculated using the backsight observation(s) made during the station setup.

Use **Measure topo** (after performing a station setup) to:

- measure face 1 or face 2 observations and create MTA records

Note - You can measure multiple rounds using *Measure topo*. However, Trimble recommends *Measure rounds* as a more suitable method to use.

Additional notes about MTA records

- When you use *Station setup plus* or *Resection*, all observations are stored when the station setup is complete. When you use *Measure rounds*, the observations are stored at the end of each round. In all three options, the MTAs are stored at the end.
- When you use *Measure topo*, MTAs are calculated and stored on the fly.
- You can create MTAs during a station setup using *Station setup plus* and *Resection*, and also after a station setup using *Measure rounds* or *Measure topo*. When you measure the same point(s) using *Measure rounds* or *Measure topo* after *Station setup plus* and *Resection*, the Trimble Survey Controller software may produce two MTAs for the one point. When more than one MTA exists for the same point in one station setup, the Trimble Survey Controller software always uses the first MTA. To avoid having two MTAs for the same point, do not use both methods to measure a point.
- Once an MTA record is written to the job database, you cannot change it.
- You can delete a face 1 and face 2 observation but the MTA records are not updated.
- You cannot delete MTA records in review.
- In *Station setup plus*, *Resection*, or *Measure rounds*, when you use the F1... F2 or F1/F2... face order, MTAs that are created pair face 1 and face 2 observations.
- In *Station setup plus*, *Resection*, or *Measure rounds*, when you use the F1 only face order, MTAs that are created group face 1 observations.
- In *Measure topo*, MTAs that are created group together all observations for the same point.

GDM CU Programs

Trimble Survey Controller offers similar functionality to the GDM Control Unit.

To access GDM CU programs, use the Trimble function key as you would the PRG key on the GDM CU.

The following table shows where to find specific GDM CU programs within Trimble Survey Controller.

GDM CU programs in Trimble Survey Controller

GDM CU program	Trimble Survey Controller		
	Select ...	to ...	Shortcut ( + number)

20 - Station setup	<i>Survey / Station setup</i>	perform a known station setup.	20
	<i>Survey / Station setup plus</i>	perform a known station plus setup.	
	<i>Survey / Resection</i>	perform a free station or eccentric station setup.	
	<i>Survey / Refline</i>	perform an instrument setup relative to a known or unknown baseline	
21 - Z/IZ	<i>Survey / Station elevation</i>	calculate an instrument elevation	21
22 - Angle measurement	<i>Survey / Measure rounds</i>	measure one or more Face 1 (CI) and Face 2 (CII) measurements.	22
	<i>Survey / Measure topo</i>	measure individual Face 1 and/or Face 2 measurements.	30
23 - Set Out	<i>Survey / Stakeout / Points</i>	set out points with known coordinates. Points can be defined via <i>Keyin / Points</i> or obtained from a linked CSV, TXT or Trimble Survey Controller JOB file.	23
24 - Refline	<i>Survey / Station and Offset</i>	measure or set out relative to a line, arc, or road. The line, arc, or road can be defined through <i>Keyin / Line</i> , <i>Keyin / Arc</i> , or <i>Keyin / Road</i> , or imported to the Trimble Survey Controller job.	24
25 - Area Calculation	<i>COGO / Compute area</i>	calculate an area.	25
26 - Distob	<i>COGO / Compute inverse</i>	calculate an inverse between two points.	26
27 - Moving Coordinates Forward	the Trimble Survey Controller software stores raw data and automatically calculates point coordinates. There is no specific program required in the Trimble Survey Controller software to move coordinates forward. Instead, select <i>Station setup plus</i> or <i>Measure rounds</i> .		27
28 - Obstructed Point	<i>Survey / Measure topo</i> and set the method to <i>Dual-prism offset</i> .		28
29 - Roadline	<i>Survey / Stakeout / Roads</i>	measure or set out relative to a road. Roads are defined by strings or by horizontal alignments, vertical alignments, and templates defining cross sections.	29
30 - Measure Coordinates	the Trimble Survey Controller software stores raw data and automatically calculates point coordinates. There is no specific program required in the Trimble Survey Controller software to measure coordinates. Instead, use <i>Measure topo</i> . Points can be exported to a CSV or TXT file, through <i>Files / Import/Export / Send data to another device</i> , for use as a control file. To access the control file from another job, select the CSV, TXT, or JOB file as a linked file through <i>Files / Properties of current job</i> .		30
32 - Angle measurement plus	<i>Survey / Measure rounds</i>	measure one or more Face 1 (CI) and Face 2 (CII) measurements.	32
	<i>Survey / Measure rounds / Options</i>	configure the number of rounds to be measured; select automatic measurements; set the observation order;	

		measure distances on Face 2(CII); define a time interval between rounds (automatic measurements only).	
33 - Robotic Lite	Not supported		-
39 - Roadline 3D	<i>Survey / Stakeout / Roads</i>	measure or set out relative to a road. Roads are defined by strings or horizontal alignments, vertical alignments, and templates defining cross sections.	39
43 - Enter coordinates	<i>Keyin / Points</i>	enter the coordinates for a point.	43
45 - Pcode	<i>Configuration / Feature and attribute libraries</i>	create a feature library with codes. To create a full feature and attribute library, or a feature and attribute library with both codes and attributes, use Feature and Attribute Editor or Autodraft Configuration File Editor. You can then transfer the feature and attribute library to the controller.	45
60 - Athletics	Not Supported		-
61 - COGO	<i>COGO / Compute point</i>	perform similar coordinate calculations.	61
65 - Direct Reflex	<i>COGO / Compute point</i>	perform a From a baseline (Corner + distance), Brng-Line intersect (Corner + angle), or Four point intersection (Two lines intersection) measurement.	65
	<i>Survey / Measure topo</i>	perform a Circular Object (Eccentric object) measurement.	
	<i>Survey / Surface scan</i>	perform a surface scan.	
66 - Monitoring	<i>Survey / Measure rounds</i>	configure the number of rounds to be measured, automatically store points, and define a time interval between rounds.	66
	<i>Survey / Measure rounds / Options</i>		
Menu 2 (View/Edit)	<i>Files / Review current job</i>	review and edit the data stored in the job.	
	<i>Favorites / Review</i>		
	<i>Favorites / Point manager</i>		
F 6 (Change target height)	the target icon on the status bar	quickly change the target details for new observations.	
F 33 (Change prism constant)			
Edit target height or Prism constant	<i>Favorites / Review current job</i>	edit the target record to change the target height or prism constant. Changes then apply to all observations that use that target.	
	<i>Favorites / Point manager</i>	use <i>Point manager</i> to edit the height or prism constant values for individual observations For more information, refer to the Help.	
GDM Job Files export	Trimble Data Transfer (connected to Trimble Survey Controller)	transfer the GDM Job file. For more information about transferring data, see Transferring Files between the Controller and the Office Computer.	

<i>Files / Import/Export / Export custom format files</i>	create a GDM Job file
---	-----------------------

Advanced Geodetic Support

Tap *Configuration / Options* to enable the following options in Advanced Geodetic support:

- **Station setup scale factor**
- **Helmert transformation for Resection**

Station setup scale factor

When you turn on Advanced Geodetic support, you can apply an additional scale factor to every conventional station setup. All measured horizontal distances are adjusted by this scale factor. To configure the scale factor settings, select *Options* during a *Station setup* , *Station setup plus* , or *Resection*.

This station setup scale factor can be Free (computed) or Fixed. If you have chosen to compute a station setup scale factor, you must observe at least one distance to a backsight during the station setup so that a scale factor can be calculated.

Helmert transformation for Resection

When you turn on Advanced Geodetic support, *Resection* has an additional computation method called Helmert transformation. To perform a resection using a Helmert transformation, select *Options* during a *Resection*, and then set the *Resection type* to *Helmert*.

Note - The standard resection type is the same as the resection method used when Advanced Geodetics is turned off.

For a Helmert transformation, you must measure distances to the backsight points. The resection calculation will not use a backsight point without a distance measurement.

For more information, see [Neighborhood Adjustment](#).

Angles and distance

In a conventional survey, use this measurement method to measure a point by angles and a distance.

Angles only and H.Angle only

In a conventional survey, use this measurement method to measure a point by both a horizontal and vertical angle or by a horizontal angle only.

Survey - Calibration

Calibration

A calibration calculates parameters for transforming WGS-84 coordinates into local grid coordinates (NEE). It either calculates a [horizontal](#) and [vertical](#) adjustment, or a transverse mercator projection and a 3-parameter datum transformation, depending on what has already been defined.

For accurate calibration, your site should be within at least four control points with known 3-D grid coordinates.

Warning - You must complete a calibration **before** you compute offset or intersection points, or stake out points. If you change the calibration after computing or staking out these points, they will not be consistent with the new coordinate system and any points computed or staked out after the change.

To calibrate point coordinates:

1. Enter the grid coordinates of your control points. Key these in, transfer them from your office computer, or measure them using a conventional total station.
2. Measure the points with GPS.
3. Perform either an [automatic](#) or a [manual](#) calibration.
4. To obtain the current list of points being used in the calibration, select *Survey / Site calibration*.

Notes and Recommendations

- You can perform a calibration using one of the real-time GPS survey styles in the Trimble Survey Controller software. Do this manually, or let the Trimble Survey Controller software do it automatically. If all the points have been measured, you do not need to connect the Trimble controller to a receiver during a manual calibration.
- Multiple calibrations can be performed in one job. The last calibration performed and applied is used to convert the coordinates of all previously surveyed points in the database.
- You can use up to 20 points for a calibration. Trimble strongly recommends that you use a minimum of four 3D local grid coordinates (N, E, E) and four observed WGS84 coordinates, with the local projection and datum transformation parameters (the coordinate system). This should provide enough redundancy.

Note - You can use a combination of 1D, 2D, and 3D local grid coordinates. If no projection and no datum transformation are defined, you must have at least one 2D grid point.

If you did not specify the coordinate system, the Trimble Survey Controller software calculates a Transverse Mercator projection and a three-parameter datum transformation.

- Use the Trimble Geomatics Office software, Trimble's Data Transfer utility, or ASCII transfer to transfer control points.
- Be careful when naming points that are to be used in a calibration. Before you begin, familiarize yourself with the [Database search rules](#).

- The set of WGS-84 coordinates must be independent of the set of grid coordinates.
- You select the grid coordinates. Select the vertical coordinates (elevation), the horizontal coordinates (northing and easting values), or all of these together.
- Place the calibration points around the perimeter of the site. Do not survey outside of the area enclosed by the calibration points, as the calibration is not valid beyond this perimeter.
- The origin of the horizontal adjustment is the first point in the calibration. The origin of the vertical adjustment is the first point in the calibration with an elevation.
- When reviewing a calibration point in the database, notice that the WGS84 values are the *measured* coordinates. The grid values are derived from these, using the current calibration.

The original keyed-in coordinates remain unchanged. (They are stored elsewhere in the database as a point with the *Type* field showing *Keyed in coordinates* and the *Stored as* field showing *Grid*.)

- When you are calibrating a no projection, no datum job, (where ground coordinates are required after calibration) you must define the project height (average site height). When the job is calibrated, the project height is used to compute a ground scale factor for the projection, using the inverse of the ellipsoid correction.
- When you start a Scale Factor Only job and then introduce GPS data, you must perform a site calibration to relate the GPS data to the Scale Factor Only point coordinates.

When you select *Site Calibration*, you must specify whether the Scale Factor Only coordinates in the job represent grid coordinates or ground coordinates. The site calibration computations then set up a grid coordinate system or a ground-based coordinate system, that best fits the existing data in the job to the GPS data.

Configuring the Survey Style for a Site Calibration

A calibration calculates parameters for transforming WGS-84 coordinates into local grid coordinates (NEE). Set the parameters for computing a calibration when you create or edit a Survey Style.

To set the parameters for computing a calibration, select the *Site calibration* survey style option from *Configuration / Survey styles*, selecting a real time survey, and do the following:

1. The *Fix H. scale field to 1.0*: check box details whether the calibration computation should compute a horizontal scale factor or not:
 - ◆ To compute the horizontal scale factor, make sure the check box is clear. (This is the default setting.) Use this option only if GPS measurements need to be scaled to fit the local control. (GPS measurements are usually more precise.)
 - ◆ To fix the horizontal scale factor to 1.0, select the check box. Select the check box to avoid distorting the geometry of the GPS network, but note that the calibration residuals will be higher.
2. Select an observation type appropriate to a calibration point. The options for a calibration point are Topo point or Observed control point.
3. For the Trimble Survey Controller software to automatically perform a calibration when you measure a calibration point, select the *Auto calibrate* check box. To switch automatic calibration off, clear the check box.
4. If necessary, set the tolerances for maximum horizontal and vertical residuals, and maximum and

minimum horizontal scale settings. These settings only apply to automatic calibration and do not affect manual calibration.

You can also specify the maximum slope of the vertical adjustment plane. The Trimble Survey Controller software warns you if the slope in the north direction or the slope in the east direction exceeds this. Generally the default settings are appropriate.

5. Specify how the calibration points you measure will be named:
 - ◆ In the *Method* field, choose one of the following options: *Add prefix*, *Add suffix*, or *Add constant*.
 - ◆ In the *Add* field, enter the prefix, suffix, or constant.

The table below shows the different options and gives an example of each.

Option	What the software does	Example value in the Add field	Grid point name	Calibration point name
Same	Gives the calibration point the same name as the grid point	-	100	100
Add prefix	Inserts a prefix before the grid point name	GPS_	100	GPS_100
Add suffix	Inserts a suffix after the grid point name	_GPS	100	100_GPS
Add constant	Adds a value to the grid point name	10	100	110

For more information, see:

- [Calibration](#)
- [Calibration - Automatic](#)
- [Calibration - Manual](#)

Calibration - Manual

Key in the grid coordinates of your control points. Alternatively, transfer them from your office computer, or use a conventional instrument to measure them. Then measure the points with GPS.

To carry out a manual calculation:

1. From the main menu, select *Survey / Site calibration*.
2. For *Scale factor only* jobs:
 - ◆ If the job uses ground coordinates, select *Ground*.
 - ◆ If the job uses grid coordinates, select *Grid*.
3. Use *Add* to add a point to the calibration.
4. Enter the name of the grid point and the WGS-84 point in the appropriate fields.

The two point names do not have to be the same, but they should correspond to the same physical

point.

5. Change the *Use* field as required and tap *Accept*.

The residuals for each point are not displayed until at least three 3D points are included in the calibration to provide redundancy.

6. Tap *Results* to see the horizontal and vertical shifts that the calibration has calculated.
7. To add more points, tap *Esc* to return to the calibration screen.
8. Repeat steps 3 through 6 until all the points are added.
9. Do one of the following:
 - ◆ If the residuals are acceptable, tap *Apply* to store the calibration.
 - ◆ If the residuals are not acceptable, recalculate the calibration.

Recalculating a Calibration

Recalculate a calibration if the residuals are not acceptable, or if you want to add or delete points.

To recalculate a calibration:

1. From the *Survey* menu, choose *Site calibration*.
2. Do one of the following:
 - ◆ To remove (exclude) a point, highlight the point name and then tap *Delete*.
 - ◆ To add a point, tap *Add*.
 - ◆ To change the components used for a point, highlight the point name and tap *Edit*. In the *Use* field, choose whether to use the vertical coordinate of the grid point, the horizontal coordinates, or both horizontal and vertical coordinates.
3. Tap *Apply* to apply the new calibration.

Note - Each calibration calculation is independent of the previous one. When a new calibration is applied, it overwrites any previously calculated calibration.

Calibration - Automatic

When you use this function to measure calibration points, the calibration calculations are performed and stored automatically.

Define a projection and datum transformation. Otherwise, a transverse mercator projection will be used and the datum will be WGS-84.

To use automatic calibration:

1. Select your *RTK Survey Style*.
2. Select *Site calibration*.
3. Select the *Auto calibrate* check box. Alternatively, tap *Options* when you measure a *Calibration point*.

4. Use *Options* to configure the naming relationship between the grid and WGS-84 points.
5. Enter the grid coordinates of your Calibration points. Key these in, transfer them from your office computer, or measure them using a conventional total station.

For keyed in coordinates check that the coordinate fields are *North*, *East*, and *Elevation*. If they are not, tap *Options* and change the *Coordinate view* to *Grid*. Key in the known grid coordinates and tap *Enter*.

Select the *Control point* check box. (This ensures that the point is not overwritten by a measured point.)

For transferred coordinates make sure that these coordinates are:

- ◆ transferred as grid coordinates (N, E, E), not as WGS84 coordinates (L, L, H)
 - ◆ control class points
6. Measure each point as a Calibration point.

In the *Method* field, select *Calibration point*.

7. Enter the grid point name. The Trimble Survey Controller software names the GPS point automatically, using the naming relationship that you configured earlier. The Auto-calibrate function then matches the points (grid and WGS-84 values), and calculates and stores the calibration. The calibration is applied to all previously measured points in the database.
8. When you measure the next Calibration point, a new calibration is calculated using all of the Calibration points. It is stored and applied to all previously measured points.

When one point has been calibrated, or a projection and datum transformation have been defined, the *Find* softkey appears. You can use this to navigate to the next point.

The calibration residuals are only displayed if the calibration tolerances are exceeded.

If this happens, consider removing the point with the most extreme residuals. Do one of the following:

- If at least four points are left after removing that point, recalibrate using the remaining points.
- If not enough points are left after removing that point, measure it again and recalibrate.

It may be necessary to remove (re-measure) more than one point. To remove a point from the calibration calculations:

1. Highlight the point name and tap *Enter*.
2. In the *Use* field, select *Off* and tap *Enter*. The calibration is recalculated and the new residuals are displayed.
3. Tap *Apply* to accept the calibration.

To view the results of an automatic calibration:

1. From the *Survey* menu, choose *Site calibration*. The *Site calibration* screen appears.

2. Tap *Results* to see the *Calibration results*.

To change a calibration that has been calculated using the *Auto calibrate* function, select *Site calibration* from the *Survey* menu. Then proceed as described in [Performing a Manual Site Calibration](#) .

Survey - GPS

Starting the Base Receiver

This chapter describes how to start the base receiver for a GPS survey.

For more information, go directly to these topics in this section:

[Base Station Coordinates](#)

[Setting up the Equipment for a Real-Time Survey](#)

[Setting up the Equipment for a Postprocessed Survey](#)

[Setting up the Equipment for a Real-Time and Postprocessed Survey](#)

[Starting a Base Survey](#)

[Starting a Trimble 4000 SSe/SSi Base](#)

[Ending a Base Survey](#)

[Radios for GPS Surveys](#)

Base Station Coordinates

When you set up a base, it is important to know the WGS84 coordinates of the point as accurately as possible.

Note - Every 10 m of error in a base station coordinate can introduce up to 1 ppm scale error on every measured baseline.

The following recognized methods, listed in descending order of accuracy, are used to determine base station WGS-84 coordinates:

- Published or precisely-determined coordinates.
- Coordinates computed from published or precisely-determined grid coordinates.
- Coordinates derived using a reliable differential (RTCM) broadcast based on published or precisely-determined coordinates.
- A WAAS or EGNOS position generated by the receiver. Use this method if no control exists for the location and you have a receiver that tracks WAAS/EGNOS satellites.
- An autonomous position generated by the receiver-use this method for real-time surveys in a location where no control exists. Trimble strongly recommends that you calibrate any jobs started by this method on a minimum of four local control points.

Tip - In the U.S.A., you can regard NAD83 geodetic coordinates as equivalent to WGS-84 coordinates.

Note - If the keyed in WGS-84 coordinates differ from the current autonomous position generated by the receiver by more than 300 m, a warning message appears.

For more information about entering base station coordinates, see [Starting a Base Survey](#).

Survey Integrity

To preserve the integrity of a GPS survey, consider the following:

- When you start subsequent base receivers for a particular job, make sure that each new base coordinate is in the same terms as the initial base coordinate.

Note - Within a job, only use an autonomous position to start the *first* base receiver. An autonomous position is equivalent to an assumed coordinate in conventional surveying.

- Coordinates published by a reliable source and coordinates determined by control surveys should be in the same system.
- If subsequent base coordinates are not in the same terms, regard observations from each base as a separate job. Each needs a separate calibration.
- Because measured real-time kinematic points are stored as vectors from the base station, not as absolute positions, the origin of the survey must be an absolute WGS-84 position from which the vectors radiate.

If other base stations are subsequently set up on points measured from the original base station, all vectors are resolved back to the original base station.

- It is possible to start the base on any kind of coordinates, for example, grid or local ellipsoid coordinates. However, in a realtime survey, the Trimble Survey Controller software must store a WGS-84 position for the base when a rover survey is started. It is this position that is held fixed as the origin of the network.

When you start a rover survey, the Trimble Survey Controller software compares the WGS-84 position broadcast by the base receiver with points already in the database. If a broadcast point has the same name as a point in the database, but different coordinates, the Trimble Survey Controller software uses the coordinates that are in the database. These coordinates were keyed in or transferred by you, so it assumes that you want to use them.

If a point in the database has the same name as the one being broadcast by the base, but the coordinates are NEE or local LLH rather than WGS-84 coordinates, the Trimble Survey Controller software converts this point to WGS-84 coordinates using the current datum transformation and projection. It then uses these as the base coordinates. If no datum transformation and projection are defined, the broadcast WGS-84 point is automatically stored and used as the base.

The following diagram shows a survey using two base stations.

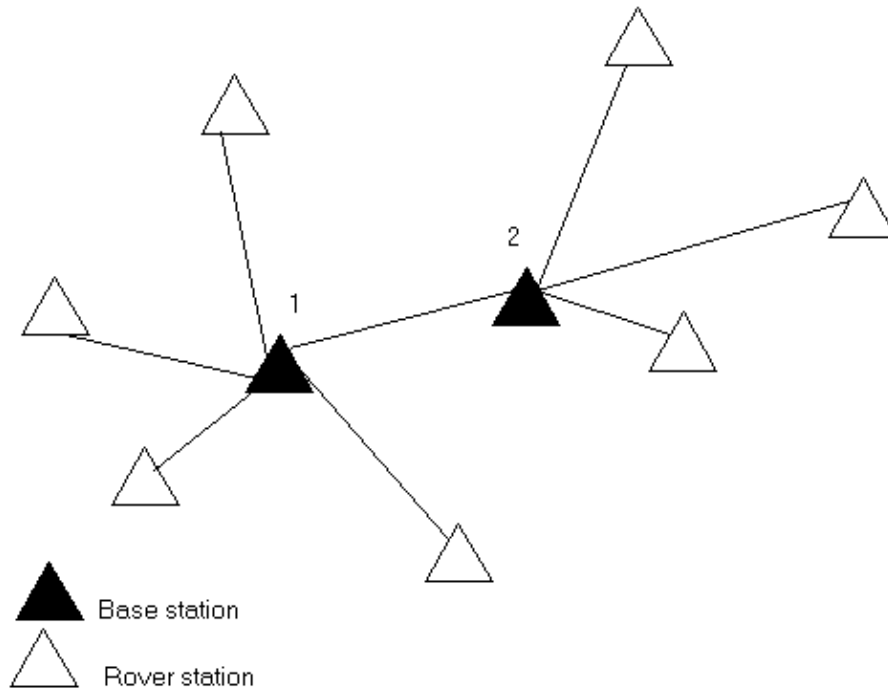

In this survey, Base station 2 was first surveyed as a roving point from Base station 1.

Note - Base stations 1 and 2 *must* be linked together by a measured baseline, and Base station 2 *must* be started with the same name that it had when it was surveyed as a roving point from Base station 1.

Setting up the Equipment for a Real-Time Survey

This section describes how to assemble the hardware components at the base receiver for a Real-time kinematic (RTK) or Real-time differential (RT differential) survey. Follow these steps if you are using a Trimble R7 or 5700 GPS receiver.

Using a Trimble R7 or 5700 GPS Receiver

To set up a base receiver for a real-time survey using a Trimble R7 or 5700 GPS receiver:

1. Set the Zephyr antenna over the ground mark using a tripod, a tribrach, and a tribrach adaptor.
2. Use the tripod clip (part number 43961) to hang the Trimble R7 or 5700 GPS receiver on the tripod.
3. Connect the Zephyr antenna to the yellow GPS receiver port labeled "GPS". Use the yellow GPS antenna cable (part number 41300-10).

Note - Instead of hanging the receiver on the tripod, you can place the receiver in its base case. Run the antenna cable out of the portal in the side of the base case to the antenna so that the case can stay closed while the receiver is running.

4. Assemble and erect the radio antenna.
5. Connect the radio antenna to the radio using the cable attached to the antenna.
6. Connect the radio to the GPS receiver port 3.

- ◆ If using a Trimble radio, use the supplied cable.
- ◆ If using a radio provided by a third party, use the appropriate cable.

Note - For some third-party radios, a separate power supply is needed for the radio.

Warning - Do not force plugs into the receiver ports. Align the red dot on the plug with the red line on the socket and then insert the plug carefully.

7. If external power is required, connect the power supply with a 0-shell Lemo connection to port 2 or port 3 on the receiver.
8. Connect the controller to the GPS receiver port 1 using the 0-shell Lemo-to-Hirose cable.
9. Turn on the controller, then follow the instructions in [Starting a Base Survey](#).

The following diagram shows how to set up the base receiver for a real-time survey using a Trimble R7 or 5700 GPS receiver.

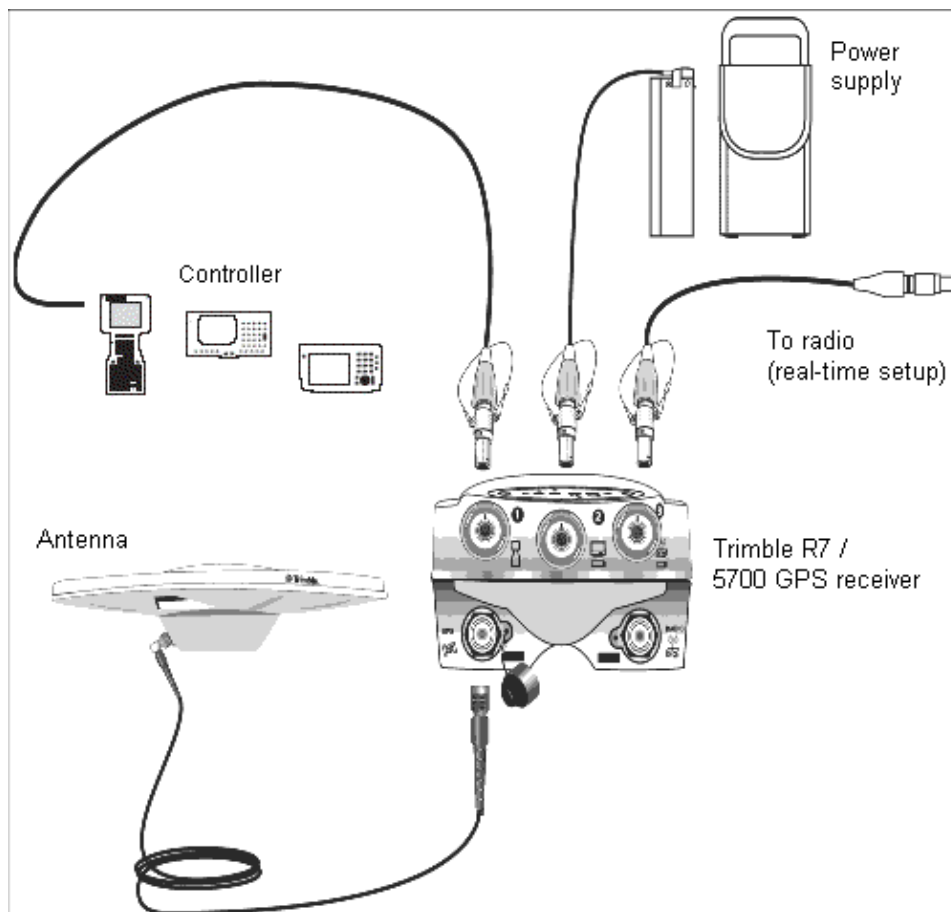

Setting up the Equipment for a Postprocessed Survey

This section shows how to assemble the hardware components at the base receiver for a postprocessed kinematic, a postprocessed differential or a FastStatic survey.

Using a Trimble R7 or 5700 GPS Receiver

To set up the base receiver for a postprocessed survey using a Trimble R7 or 5700 GPS receiver. For more information, see the [diagram](#) on setting up the base receiver. Then do the following:

1. Set the Zephyr antenna over the ground mark using a tripod, a tribrach, and a tribrach adaptor.
2. Use the tripod clip (Part Number 43961) to hang the Trimble R7 or 5700 GPS receiver on the tripod.
3. Connect the Zephyr antenna to the yellow GPS receiver port labeled GPS. Use the yellow GPS antenna cable (part number 41300-10).

Note - Instead of hanging the receiver on the tripod, you can place the receiver in its base case. Run the antenna cable out of the portal in the side of the base case to the antenna so that the case can stay closed while the receiver is running.

Warning - Do not force plugs into the receiver ports. Align the red dot on the plug with the red line on the socket and then insert the plug carefully.

7. If external power is required, connect the power supply with a 0-shell Lemo connection to Port 2 or Port 3 on the receiver.
8. Connect the controller to the GPS receiver port 1 using the 0-shell Lemo to 0-shell Lemo cable.
9. Turn on the controller, then follow the instructions in [Starting a Base Survey](#).

Setting up the Equipment for a Real-Time and Postprocessed Survey

To conduct a survey that uses both real-time and postprocessed techniques, follow the assembly instructions for real-time surveys. If the receiver has no memory (or has a limited memory), use a controller to store raw data at the base receiver.

Starting a Base Survey

To conduct a survey using a predefined survey style, make sure that the required job is open. The title of the main menu should be the current job name.

From the main menu, choose *Survey* and select a survey style from the list.

A *Survey* menu is generated. It displays items specific to the chosen survey style and includes the *Start base receiver* and *Start survey* items.

Warning - In a real-time survey, make sure that the radio antenna is connected to the radio before starting the base survey. If it is not, the radio will be damaged.

To start a base survey:

1. From the *Survey* menu, choose *Start base receiver*.
 - ◆ If the controller is connected to a receiver that was logging data, the data logging stops.
 - ◆ The first time that you use this survey style, the Style wizard prompts you to specify the equipment you are using.

The *Start base* screen appears.

Note - When you start a survey, the Trimble Survey Controller software automatically negotiates the highest possible baud rate for communicating with the connected receiver.

2. Enter the base station name and coordinates. Use one of the following methods:

- ◆ If WGS84 coordinates are known:

Access the *Point name* field and enter the point name. Tap *Key in*.

In the *Key in point* screen, set the *Method* field to *Keyed in coordinates*. Check that the coordinate fields are *Latitude*, *Longitude*, and *Height (WGS84)*. If they are not, tap *Options* and change the *Coordinate view* setting to *WGS84*. Key in the known WGS84 coordinates for the base station, and tap *Store*.

- ◆ If grid coordinates are known, and projection and datum transformation parameters are defined:

Access the *Point name* field and enter the point name. Tap *Key in*.

In the *Key in point* screen, set the *Method* field to *Keyed in coordinates*. Check that the coordinate fields are *Northing*, *Easting*, *Elevation*. If they are not, tap *Options* and change the *Coordinate view* setting to *Grid*. Key in the known grid coordinates for the base station, then tap *Store*.

- ◆ If local geodetic coordinates are known and a datum transformation is defined:

Access the *Point name* field and enter the point name. Tap *Key in*.

In the *Key in point* screen, set the *Method* field to *Keyed in coordinates*. Check that the coordinate fields are *Latitude*, *Longitude*, and *Height (Local)*. If not, tap *Options* and change the *Coordinate view* setting to *Local*. Key in the known local coordinates for the base station, then tap *Store*. In a real-time survey, select either the current WAAS/EGNOS position, or the current autonomous position, derived by the GPS receiver. Then, access the *Point name* field and enter the point name. Tap *Key in* to access the *Key in point* screen. Tap *Here* and the current position is displayed. Tap *Store* to accept and store this position.

Note - If you want a WAAS/EGNOS position, ensure the receiver is tracking a WAAS/EGNOS satellite by checking the WAAS/EGNOS icon is displayed on the status line when you tap *Here*. The receiver can take 120 seconds to lock on to WAAS/EGNOS. Alternatively, check the *Observation class* field before starting the base.

Warning - Within a job, only use an autonomous position (the *Here* softkey) to start the first base receiver.

Notes

- ◆ If you carry out a real-time survey using RTCM 2.x corrections and use a base point name that is more than eight characters long, the name will be shortened to eight characters when it is broadcast.

- ◆ If you carry out a real-time survey using RTCM 3.0 corrections, you must use a base point name (in upper case) that is within the range RTCM0000 to RTCM4095.
3. The *Observation class* field shows the observation class of the base point. For more information, see [Storing GPS points](#).
 4. Enter values in the *Code* (optional) and *Antenna height* fields.
 5. Set the *Measured to* field as appropriate.
 6. In the *Station index* field, enter a value.

This value is broadcast in the correction message, and must be in the range 0-31.

Tip - Tap *Scan* to view a list of other base stations operating on the frequency you are using. The list shows the station index numbers of the other bases and the reliability of each. Choose a different station index number to those displayed.

7. If the receiver you are using supports transmission delays, the *Transmission delay* field appears. Choose a value depending on how many base stations you intend to use. For more information about transmission delays, see [Operating Several Base Stations on One Radio Frequency](#).
8. Tap *Start*.

The base receiver starts to record data.

9. Do one of the following:

- ◆ If you are carrying out a real-time survey, the following message appears:

Base started
Disconnect controller from receiver

Disconnect the controller from the base receiver but **do not** turn off the receiver. You can now set up the rover receiver.

Note - For a real-time survey, check that the radio is working before leaving the equipment. The data light should be flashing.

- ◆ If you are logging data in the controller, the *Base* screen appears. It shows which point is being surveyed and the time that has elapsed since data logging started. Leave the Trimble controller connected to the base receiver and set up the rover using another Trimble controller.

Starting a Trimble 4000 SSe/SSi Base

You **cannot** start a Trimble 4000 SSE/SSi base receiver using the Trimble Survey Controller software version 12.0 or later.

You can start the Trimble 4000 SSE/SSi base using the front panel of the Trimble 4000 receiver, or with a controller running the Trimble Survey Controller software version 11.3x.

Ending a Base Survey

After an RTK survey, or after logging data in the receiver, end the survey as follows:

1. Return to the equipment and select *Survey / End survey*. Tap *Yes* to confirm that you want to end the survey, and again to power down the receiver.
2. Turn off the controller.
3. Disconnect the equipment.

After logging base station data in the Trimble controller, end the survey as follows:

1. Return to the equipment and tap *Enter*.
2. Tap *Yes* to confirm that you want to end the survey, and again to turn off the receiver.
3. Turn off the controller.
4. Disconnect the equipment.

Base Options

To configure the Base survey when you create or edit a Survey Style:

1. From the main menu, select *Configuration / Survey Styles / <Selected GPS Survey Style> / Base options*.
2. Choose a survey type.
3. Set the elevation mask.
4. Set the antenna type.

Output additional code RTCM

For real-time surveys, the base receiver can broadcast the RTK message and the RTCM-104 differential message at the same time. To do this, select the *Output additional code RTCM* check box. (The *RTCM output* option must be installed on your receiver.)

Note - When RTCM-104 code and CMR messages are being broadcast, the behavior of rover GPS receivers varies according to type. When you are broadcasting CMR with *Output additional code RTCM* enabled, only use Trimble R7 or 5700 GPS receivers, or 4700 and 4800 GPS receivers with firmware later than v1.2. Not all receivers will function correctly in this environment because their behavior is receiver- and manufacturer-dependent. Most RTCM-only receivers will work correctly. For more information contact your local Trimble dealer.

Warning - Do not use the *Output additional code RTCM* option when using time delays for sharing the radio frequency.

Tracking L2C

For real-time surveys where the base receiver and all rover receivers that will receive base data from that base receiver can track the L2 civil signal, select the *L2C* check box. This sets up the base GPS receiver to track the civil signal on the L2 GPS frequency and send those L2C observations to the rovers.

Tracking GLONASS

For real-time surveys where the base receiver and rover receivers that will receive base data from that base receiver can track the GLONASS signal, select the *GLONASS* check box if you want to use the GLONASS observations. This sets up the base GPS receiver to track the GLONASS signals and send those GLONASS observations to the rovers.

For postprocessed surveys where the base receiver and rover receivers can track the GLONASS signal, select the *GLONASS* check box if you want to use the GLONASS observations. This sets up the GPS receivers to track the GLONASS signals and include the signals in the logged data.

Setting Up the Equipment for a Trimble R8, R6 or 5800 GPS Survey

This section describes how to assemble the hardware at the rover receiver for a real-time and postprocessed kinematic (PP kinematic) survey. It describes the steps for a Trimble R8, R6, or 5800 GPS receiver.

For more information, go directly to these topics in this section:

[Setting up the equipment for a real-time survey](#)

[Setting up the equipment for a postprocessed survey](#)

[Starting a rover survey](#)

[Recommended RTK initialization procedure](#)

[Postprocessed initialization methods](#)

[Swapping bases during a real-time rover survey](#)

[Ending a rover survey](#)

Setting Up the Equipment for a 'Real-Time' Survey

To set up a rover receiver for a real-time survey using a Trimble R8, R6, or 5800 GPS receiver:

1. Mount the Trimble R8/R6/5800 receiver onto a range pole. Power for the Trimble R8/R6/5800 receiver is supplied by the internal battery in the receiver.
2. Attach the controller to the holder. See: [Attaching and Detaching the Trimble CU Controller](#).
3. Connect the controller holder to the range pole.
4. Turn on the Trimble R8/R6/5800 receiver.
5. Turn on the controller.

Setting Up the Equipment for a 'Postprocessed' Survey

1. Mount the Trimble R8/R6/5800 receiver onto a range pole. Power for the Trimble R8/R6/5800 is supplied by the internal battery in the receiver.

Note - It may be useful to use a bi-pole to hold the range pole while taking measurements.

2. Attach the controller to the holder. See: [Attaching and Detaching the Trimble CU Controller](#).
3. Connect the controller holder to the range pole.
4. Turn on the Trimble R8/R6/5800 receiver.

Starting a Rover Survey

Only start a survey after you have started the base receiver. For more information, see [Starting the Base Receiver](#).

To conduct a survey:

1. Make sure that the required job is open. The title of the main menu should be the current job name.
2. From the main menu, choose *Survey*. Select a survey style from the list.

Note - If you have only one survey style, it is automatically selected.

A *Survey* menu is generated. It displays items specific to the chosen survey style and includes the *Start base receiver* and *Start survey* items.

When you start a survey using a particular Trimble survey style for the first time, the Trimble Survey Controller software prompts you to customize the style for your specific hardware.

When the survey starts, the menu items *Start base receiver* and *Start survey* no longer appear. For kinematic surveys, a new item, *Initialization*, appears.

Trimble R8, Trimble R7, Trimble R6, 5800, 5700, 4800, or 4700 GPS receiver

Warning - If you start a survey while the receiver is logging data, logging stops. If you start a survey that specifies data logging, logging restarts to a different file.

Note - When you start a survey, the Trimble Survey Controller software automatically negotiates the highest possible baud rate for communicating with the connected receiver.

Starting a Real-Time Rover Survey

To start the rover receiver for a real-time survey:

1. Select *Start survey*.
2. Make sure the rover is receiving radio corrections from the base.

Note - An RTK survey needs radio corrections.

3. If the receiver you are using supports transmission delays and you select the *Prompt for station index* check box in the *Rover options* field, the *Select base station* screen appears. It shows all the base stations operating on the frequency you are using. The list shows the station index numbers of each base and the reliability of each. Highlight the base you want to use and tap *Enter*.

For more information about using transmission delays, see [Multiple bases on one frequency](#).

Tip - If you want to check the point name of the base station being used in the rover survey, select *Files / Review current job* and inspect the *Base point record*.

4. If necessary, initialize the survey.

Note - If you are carrying out an RTK survey but do not require centimeter-level results, select *Survey / Initialization*. Tap *Init* and set the *Method* field to *No initialization*.

For an RTK survey, initialize before starting centimeter-level surveying. If you are using a dual-frequency receiver with the OTF option, the survey automatically starts to initialize using the *OTF initialization* method.

5. When the survey is initialized, you can perform a site calibration, measure points, or stakeout.

Starting an RTK & Infill Rover Survey

Note - If you are using postprocessed techniques, to process the data you must have the Baseline Processing module of the Trimble Geomatics Office software installed.

To start the rover receiver for an RTK & infill survey:

1. Select *Start Survey*.
2. Make sure the rover is receiving radio corrections from the base.

Note - An RTK survey needs radio corrections.

3. If the receiver you are using supports transmission delays and the *Prompt for station index* check box in the *Rover options* option in the survey style is selected, the *Select base station* screen appears. It shows all the base stations operating on the frequency you are using. The list shows the station index numbers of each base and the reliability of each. Highlight the base you want to use and tap *Enter*.

For more information about using transmission delays, see [Multiple bases on one frequency](#).

Tip - If you want to check the point name of the base station being used in the rover survey, select *Files / Review current job* and inspect the *Base point record*.

4. Initialize the survey using an [RTK initialization](#) method.
5. Measure points as usual.

Switching to PP infill

During periods when no base corrections are received, the following message flashes in the status line:

Radio link down

To continue surveying select *Start PP infill* from the *Survey* menu. When postprocessing infill starts, this item changes to *Stop PP infill*.

Raw data is logged at the rover during postprocessing (PP) infill. For successful baseline resolution, you must now use postprocessed kinematic observation techniques.

Note - Initialization cannot be transferred between the RTK survey and the PP infill survey. Initialize the PP infill survey like any other postprocessed kinematic survey. For more information, see [Postprocessed Initialization Methods](#).

Only rely on the OTF (automatic) initialization if you are certain that the receiver will observe at least five satellites, without interruption, for the next 15 minutes. Otherwise, select *Initialization* from the *Survey* menu and perform an initialization.

Note - You cannot stake out points during a postprocessed survey.

When base corrections are received again, one of the following messages appears in the status line, depending on the initialization mode of the RTK survey:

- Radio link up (RTK=Fixed)
- Radio link up (RTK=Float)

The first message is displayed if the receiver has retained the RTK initialization during the PP infill survey. That is, if the number of satellites did not fall below four throughout the PP infill survey.

Select *Stop PP infill* from the *Survey* menu to stop data logging at the rover. When postprocessing infill stops, this item changes back to *Start PP infill*. Real-time measurements are resumed.

Starting a Postprocessed Rover Survey

To start the rover receiver for a postprocessed survey, select *Start survey*.

Note - If using postprocessed techniques, to process the data you must have the Baseline Processing module of the Trimble Geomatics Office software installed.

You can begin surveying immediately, you do not need to initialize a [FastStatic](#) or [differential](#) survey.

You must initialize a PP kinematic survey to achieve centimeter-level precisions when the data is processed. With dual-frequency receivers, the initialization process begins automatically if at least five L1/L2 satellites are being observed.

For more information about initializing a postprocessed survey, see [Postprocessed Initialization Methods](#). For information about measuring points, see [Measure Points](#).

Working in Float mode

Work in Float mode if you do not want to initialize a survey. Start the survey and select *Initialization*. When the *Initialization* screen appears, press *Init*. Set the *Method* field to *No initialization* and tap *Enter*.

Starting a Rover Survey

Starting a rover survey is the same as for a [Real-time](#) survey.

To start a survey using VRS or SAPOS FKP, you must send an approximate position for the rover receiver to the control station. When you start the survey, this position is automatically sent through your radio communications link in a standard NMEA position message. It is used to compute the RTK corrections your receiver will use.

Swapping Bases During a Real-Time Rover Survey

If you are using multiple bases on the same frequency, you can swap bases during the rover survey. For more information, see [Multiple bases on one frequency](#).

To swap bases, do the following:

- From the *Survey* menu, select *Swap base receiver*.

The *Select base station* screen appears. It shows all the base stations operating on the frequency you are using. The list shows the station index numbers of each base and the reliability of each. Tap the base you want to use.

Note - When you change to a different base, your OTF receiver automatically starts the initialization.

Ending a Rover Survey

When you have measured or staked out all points required, do the following:

1. From the *Survey* menu, choose *End survey*.

The Trimble Survey Controller software asks if you want to power down the receiver. Tap *Yes* to confirm this.

Note - When using a Trimble R3 receiver you are not prompted to turn off the receiver. The receiver turns off when the controller is turned off.

2. Turn off the controller **before** disconnecting the equipment.
3. Return to the base station and end the base survey. For more information, see [Ending a Base Survey](#).

Rover Options

To configure the Rover survey when you create or edit a Survey Style:

1. From the main menu, select *Configuration / Survey Styles / <Selected GPS Survey Style> / Rover options*.
2. Choose a survey type and set the associated parameters.

Generally, when a GPS Total Station setup consists of one base and one rover receiver, make sure the survey type selected in the *Rover options* field and the *Base options* field is the same. However, when there are multiple rovers, you can have various configurations. The following table shows the rover survey types that are possible when the base survey type is RTK & infill or PP Kinematic.

Base survey type	Possible rover survey types
RTK & infill or RTK & data logging	RTK RTK & infill PP Kinematic FastStatic
PP Kinematic	PP KinematicFastStatic

Broadcast format

For Real-time Kinematic surveys, the format of the broadcast message can be CMR, CMR +, or RTCM RTK. CMR is Compact Measurement Record; RTCM is Radio Technical Commission for Maritime Services.

The default is CMR +, which is a format used by the modern Trimble receivers. It is a modified type of CMR record that improves the efficiency of a low bandwidth radio link in realtime surveys. Only use CMR + if all the receivers have the CMR + option installed. To check if this option is installed in the receiver, select *Instrument / Options* on the controller that is connected to a receiver.

Note - If you want to operate several base stations on one frequency, use CMR+. For more information, see [Operating several base stations on one radio frequency](#).

For [wide-area](#) RTK surveys, the broadcast message format can be from the following wide-area RTK solutions: SAPOS FKP, VRS (CMR), and VRS (RTCM). For more information, see [Starting a wide area RTK survey](#).

For [wide-area](#) RTK surveys, the broadcast message format can be from the following wide-area RTK solutions: SAPOS FKP, VRS (CMR), VRS (RTCM), and RTCM3Net. For more information, see [Starting a wide area RTK survey](#).

Network RTK is also supported in the form of "Multi station" surveys with both CMR and RTCM formats. These surveys allow you to connect to a network service provider by cellular modem or through the Internet, and receive CMR or RTCM data from the nearest physical reference station in the network.

The rover selection should always correspond to the broadcast message format generated by the base.

Satellite differential

When the radio link is down in a real-time survey, the receiver can track and use signals from a Wide Area Augmentation System (WAAS) available in North America, or from the European Global Navigation Overlay Service (EGNOS) available in Europe. These systems provide WAAS/EGNOS positions instead of autonomous GPS positions.

To use WAAS/EGNOS positions for more accurate navigation when the radio link is down, set the *Satellite differential* field to either WAAS or EGNOS. To use WAAS/EGNOS at times when the satellites are broadcasting in test mode, select the *Ignore health* option.

Note - For WAAS/EGNOS surveys, you must use a receiver that can track WAAS/EGNOS satellites.

Use station index

If you want to use multiple base stations on one radio frequency, enter the station index number that you want to use first in the *Use station index* field.

If you do not want to use multiple base stations on one frequency, enter the same station index number that you enter in the *Base options* screen.

To use any base station operating on the frequency set in the rover radio, tap *Any*.

Warning - If you tap *Any* and there are other base stations operating on the frequency, your rover survey could receive corrections from the wrong base.

For information about using multiple bases, see [Multiple bases on one frequency](#).

Prompt for station index

When you use a receiver that supports multiple base stations on one radio frequency, the Trimble Survey Controller software asks you to specify the base to use when you start the rover survey. You can stop this question from appearing by clearing the *Prompt for station index* check box. The station index number in the *Use station index* field is used.

Elevation mask

You must define an elevation mask below which satellites are not considered. For kinematic applications, the default of 10° is ideal for both the base and rover.

For differential surveys where the base and rover are separated by more than 100 kilometers, Trimble recommends that the base elevation mask be lower than the rover setting by 1° per 100 kilometers of separation between the base and rover. Generally, the base elevation mask should be no lower than 10°.

PDOP mask

For the rover option, define a PDOP mask. The Trimble Survey Controller software issues high PDOP warnings when the satellite geometry goes above this threshold. The default value is 6.

Logging device

With survey types that involve postprocessing, set the Logging device to be either the Receiver or Controller.

To define the logging interval, enter a value in the *Logging interval* field. The base and rover logging intervals must correspond to (or be multiples of) each other.

Antenna type

To set the default antenna height, enter a value in the *Antenna height* field.

To define the antenna details, access the *Type* field and select the correct antenna from the list of antennas. Access the *Measured to* field and select the correct measurement method for the equipment and type of survey. The field that displays the part number is automatically filled. Key in the serial number.

Tracking L2C

For real-time surveys where the base data contains L2C observations, select the *L2C* check box. This sets up the rover GPS receiver to track the civil signal on the L2 GPS frequency to match what the base station receiver is tracking.

Use this option only when the base receiver can track L2C, and when you selected the *L2C* box in the base options when you started the base survey.

Tracking GLONASS

For real-time surveys where the base data contains GLONASS observations, select the *GLONASS* check box. This sets up the rover receiver to track the GLONASS satellites to match what the base station receiver is tracking.

You can use this setting to track GLONASS satellites at the rover even if the base receiver is not tracking GLONASS. However, the satellites will not be used in the RTK processing.

For postprocessed surveys where the base receiver and rover receivers can track the GLONASS signal, select the *GLONASS* check box if you want to use the GLONASS observations. This sets up the GPS receivers to track the GLONASS signals and include the signals in the logged data.

Measuring Antenna Heights

The following describes how to measure the height of an antenna mounted on a range pole when the *Measured to* field is set to *Bottom of antenna* or *Bottom of antenna mount*. With a fixed height range pole, the height is a constant value.

Measuring the Height of an Antenna on a Tripod

The way to measure this depends on the equipment used.

Zephyr antenna

If this antenna is mounted on a tripod, measure the height to the top of the notch on the side of the antenna.

Refer to the following diagram where (1) is the Zephyr antenna, (2) is the corrected height to APC and (3) is the uncorrected height.

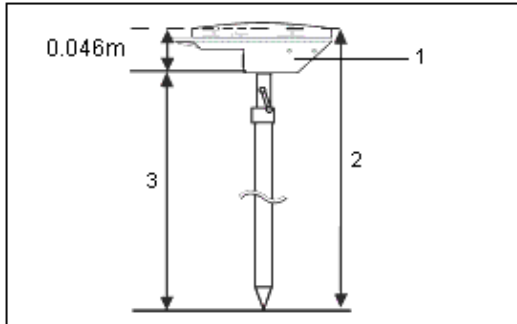

Zephyr Geodetic antenna

If this antenna is mounted on a tripod, measure the height to the bottom of the notch on the side of the antenna.

Trimble R8, R6, and 5800 GPS receiver

If this receiver is mounted on a tripod, measure the height to the bottom of the groove between the gray base and the white top of the antenna, and select *Center of bumper* in the *Measured to* field.

Refer to the following diagram where (1) is the Trimble GPS receiver, (2) is the corrected height to APC and (3) is the uncorrected height of 1.80m.

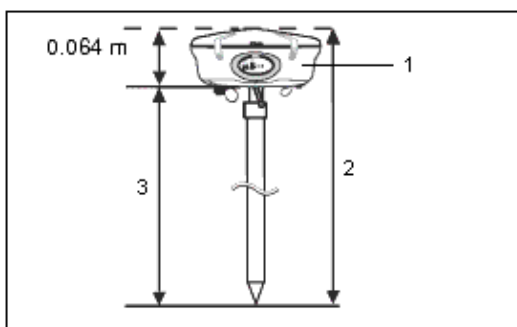

Tip - If you are using a fixed height tripod, you can measure the height to the bottom of the antenna housing and select *Bottom of antenna mount* in the *Measured to* field.

Micro-centered L1/L2 antenna

If this antenna is mounted on a tripod, measure the height to the bottom of the plastic housing. Enter this value in the *Antenna height* field and set the *Measured to* field to *Bottom of antenna*.

Refer to the following diagram where (1) is the Micro-centered antenna, (2) is the corrected height to APC and (3) is the uncorrected height.

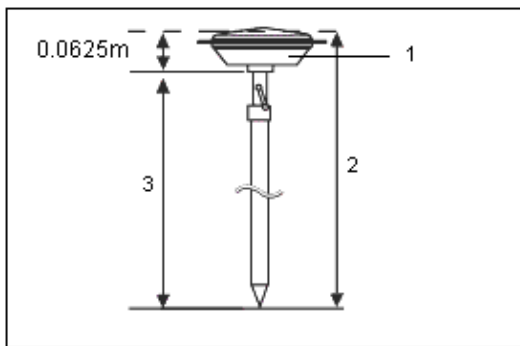

Ground plane

If you are using a ground plane, see the next section.

Measuring the Height of an Antenna When Using a Ground Plane

If the Micro-centered antenna (or a Compact L1/L2 antenna) has a ground plane measure to the underside of the notch in the ground plane.

Refer to the following diagram where (1) is the Micro-centered L1/L2 antenna, (2) is the ground plane, (3) is the underside of the notch and (4) is the top of the notch.

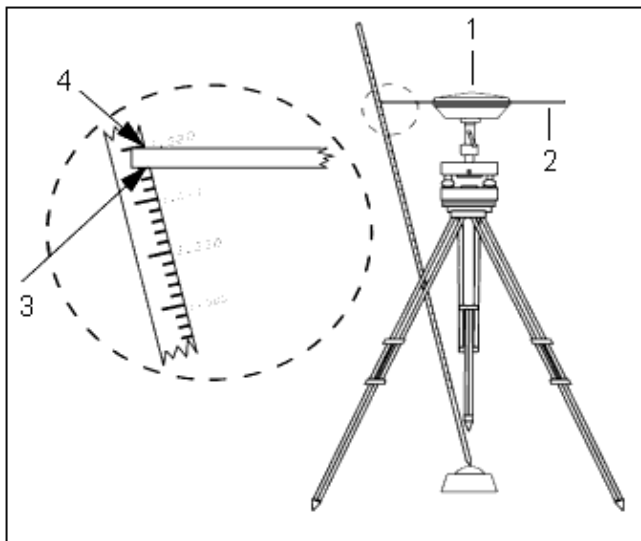

Tip - Measure the height to three different notches around the perimeter of the ground plane. Then record the average as the uncorrected antenna height.

Antenna.ini File

The Trimble Survey Controller software includes an integrated Antenna.ini file that contains a list of antennas that you can choose from when creating a survey style. You cannot edit this list in the Trimble Survey Controller software. However, if you want to shorten the list or add a new antenna type, you can edit and transfer a new Antenna.ini file.

To edit the antenna.ini file, use a text editor such as Microsoft Notepad. Edit the *Trimble Survey Controller* group, and transfer the new Antenna.ini file to the Trimble Survey Controller software, using Trimble's Data Transfer utility.

Note - When you transfer an Antenna.ini file, it overwrites any existing file of that name. The information in this file is also used in preference to the antenna information built into the Trimble Survey Controller software.

RTK Initialization Methods

If base corrections are being received and there are sufficient satellites, the survey is initialized automatically when you start the survey. A survey must be initialized before centimeter-level surveying can begin.

The number of satellites required depends on whether you are using GPS satellites only, or a combination of GPS and GLONASS satellites. The following table summarizes the requirements.

Minimum L1/L2 satellites required for initialization

Satellite Systems	GPS	GLONASS
GPS only	5	0
GPS + GLONASS	4	2
GPS + GLONASS	3	3
GPS + GLONASS	2	4
GLONASS only	N/A	N/A

Note - You cannot initialize if the DOP is greater than 7.

After initialization, a position can be determined and the initialization can be maintained with one satellite less than the number required to initialize. If the number of satellites drops below this number, the survey must be reinitialized.

The following table summarizes the requirements.

Minimum L1/L2 satellites required to maintain initialization and produce positions

Satellite Systems	GPS	GLONASS
GPS only	4	0

GPS + GLONASS	4	1
GPS + GLONASS	3	2
GPS + GLONASS	2	3
GPS + GLONASS	1	4
GLONASS only	N/A	N/A

After initialization, the survey mode changes from Float to Fixed. The mode remains Fixed if the receiver continuously tracks the minimum number of satellites. If the mode changes to Float, you must reinitialize the survey.

Multipath

Initialization reliability depends on the initialization method used and on whether or not multipath occurred during the initialization phase. Multipath occurs when GPS signals are reflected off objects, such as the ground or a building.

The occurrence of multipath at the GPS antenna adversely affects GPS initializations and solutions:

- If initialization is by the Known Point method, multipath can cause an initialization attempt to fail.
- During initialization by the OTF method, it is difficult to detect multipath, which may cause initialization to be lengthy or unsuccessful. For more information, see [Recommended RTK Initialization Procedure](#).

The initialization process in Trimble receivers is very reliable, but if an incorrect initialization does occur, Trimble's RTK processing routines detect it, discards the initialization automatically and issues a warning.

Note - If you survey points with a bad initialization, you will get position errors. To minimize the effect of multipath during an OTF initialization, move around.

Known Point Initialization

To perform a Known Point initialization:

1. Position the rover antenna over a known point.
2. From the *Survey* menu, choose *Initialization*.
3. Set the *Method* field to *Known Point*.
4. Access the *Point name* field and tap *List*. Select the point from the list of known points.
5. Enter values in the *Antenna height* field, and make sure that the setting in the *Measured to* field is correct.
6. When the antenna is centered and vertical over the point, tap *Start*.

The controller starts to record data, and the static icon () appears in the status bar. Keep the antenna vertical and stationary while data is recorded.

7. When the receiver is initialized, the following message appears:

Initialization change. Initialization has been gained. The results are displayed. Tap *Accept* to accept

the initialization.

8. If the initialization fails, the results are displayed. Tap *Retry* to retry the initialization.

Recommended RTK Initialization Procedure

This section describes the procedure that Trimble recommends for performing a check on an OTF RTK initialization.

Minimize the chance of surveying with a bad initialization by adopting good survey techniques. A bad initialization occurs when the integer ambiguities are not correctly resolved. The Trimble Survey Controller software automatically reinitializes when this is detected, but cannot do so if you end the survey too soon. As a precaution, always perform the RTK initialization described below.

When initializing, always choose a site that has a clear view of the sky and is free of obstructions that could cause multipath.

Note - Known Point is the quickest method of initialization when known points exist.

To perform an On-The-Fly initialization:

1. Initialize the survey using the OTF method of initialization.

Tip - When performing an OTF initialization, move around to reduce the effect of multipath.

2. When the system is initialized, establish a mark about 9 meters (30 feet) from where the initialization occurred.
3. Conduct a static point measurement over the mark. Once this is done, discard the current initialization.
4. If you are using an adjustable height range pole, change the height of the antenna by approximately 8 inches.
5. Reoccupy the mark observed in step 2, and reinitialize the survey using either the OTF or Known Point method of initialization. Remember to enter the new antenna height details.

Follow this procedure to substantially improve the quality of an initialization.

Measuring a new point creates a known point on which the first initialization is tested. Changing the antenna height moves the GPS antenna from the environment in which the test point was initially surveyed. Always enter the new antenna height before starting the Known Point initialization.

Postprocessed Initialization Methods

In a postprocessed survey you must initialize to attain centimeter-level precisions.

Use one of the following methods to initialize dual-frequency postprocessed kinematic surveys in the field:

- On-The-Fly
- Known Point

Note - In a postprocessed survey, collect enough data during initialization so that the WAVE processor can successfully process it. The following table shows Trimble's recommended times.

Initialization method	4 SVs	5 SVs	6+ SVs
L1/L2 OTF initialization	N/A	15 min	8 min
Known Point initialization	at least four epochs		

After initialization, the survey mode changes from Float to Fixed. The mode remains Fixed if the receiver continuously tracks at least four satellites. If the mode changes to Float, reinitialize the survey.

Note - If you do an On-The-Fly initialization in a postprocessed kinematic survey, it is possible to measure points before initialization is gained. The Trimble Geomatics Office software can back-process the data later to give a fixed solution. If you do this but lose lock on the satellites while initializing, re-measure any one of the points that you surveyed before lock was lost.

To work without initializing the survey (in Float mode), start a survey and select *Initialization*. When the *Initialization* screen appears, tap *Init*. Set the *Method* field to *No initialization* and tap *Enter*.

Known Point Initialization

In a postprocessed survey you can initialize on:

- a point measured previously in the current job
- a point that you will provide coordinates for later (before the data is postprocessed)

See [Known Point initialization](#) for instructions.

RTK Survey

Real-time kinematic surveys use a radio to broadcast signals from the base station to the rover. The rover then calculates its position in real time. Configure this type of survey when you create or edit a Survey Style, then follow these steps to carry out an RTK survey:

1. [Configure the survey style](#)
2. [Configure the base receiver](#)
3. [Configure the rover receiver](#)
4. [Begin the survey](#)
5. [End the survey](#)

Configure the survey style

To do this:

1. From the main menu, select *Configuration / Survey styles / RTK*.
2. Select each of the options in turn, and set them to suit your equipment and survey preferences.
3. When you have configured all the settings, tap *Store* to save them.

For more information, see:

[Rover options](#)

[Base options](#)

[Radios](#)

[Laser rangefinder](#)

[Topo point](#)

[Observed control point](#)

[Rapid point](#)

[Continuous points](#)

[Stakeout](#)

[Configuring the Survey Style for a Site Calibration](#)

[Duplicate Point Tolerance](#)

Configure the base receiver

To do this:

1. Set up the base station and connect the data collector.
2. From the main menu, select *Survey / RTK / Start base receiver*. If you are using this Survey Style for the first time, the Style wizard prompts you to specify the type of equipment you are using.

The style wizard customizes the chosen survey style, setting any parameters specific to the hardware.

Tip - To correct a mistake when customizing a survey style, first complete the process and then edit the style.

Note - With the Trimble R7, 5800, 5700, 4800 or 4700 GPS receivers, use an external radio at the base even if you use the internal radio at the rover.

Tip - You can use a Custom radio if the radio you have is not listed.

3. Enter the point name. If the WGS-84 point is not already in the database, the *Key in / Point* screen appears.
4. Enter values, or tap *Here* to use the current position. Only use *Here* once in a job.
5. Enter the code.
6. Enter the antenna height and tap *Enter*.
7. Disconnect the data collector from the base station.

Note - The first time that you start the base or the rover receiver, you must select the type of antenna that you are using from a list. The following table shows some common choices.

Receiver and station	GPS Total Station receivers		
	Trimble R7 / 5700	4800	4700
Base receiver	Zephyr Geodetic	4800 Internal	Micro-centered L1/L2 w/GP
Rover receiver	Zephyr	4800 Internal	Micro-centered L1/L2

Configure the rover receiver

To do this:

1. Set up the Rover receiver and connect the data collector.
2. From the main menu, select *Survey / RTK / Start survey*. Again, the Style wizard may prompt you to specify the type of equipment you are using.
3. Initialize the survey. If you have selected the *On-The-Fly (OTF)* option, initialization is automatic. Otherwise, the *Initialization* screen appears.
4. Once the rover is initialized, the survey mode in the status line shows as RTK:Fixed. You can then measure points.

Begin the survey

To do this:

1. From the main menu, select *Survey / Measure points*.
2. Enter the point name and code.
3. In the *Type* field, select *Topo point*.
4. Enter the antenna height.
5. Tap *Measure*. The antenna must remain stationary and vertical while you measure a point.
6. Tap *Store* to store the point.
7. Move to the next point and measure it.
8. To review stored points, select *Review current job* from the *Files* menu.

End the survey

To do this:

1. From the main menu, select *Survey / End GPS survey*.
2. Tap *Yes* to confirm.
3. Turn off the data collector.

For more information, see:

[Start base receiver](#)

[Measure points](#)

[Continuous topo](#)

[Stakeout](#)

[Configuring the Survey Style for a Site Calibration](#)

[Swap base receiver](#)

Operating Several Base Stations on One Radio Frequency

In an RTK survey you can reduce the effects of radio interference from other base stations on the same frequency by operating your base station with a different transmission delay. This allows you to operate several base stations on one frequency. The general procedure is as follows:

1. Check that you have the correct hardware and firmware.
2. Set up the equipment and start a survey at each base station, specifying a transmission delay and a station index number.
3. Start a rover survey and specify which base to use.

Hardware and firmware requirements

To operate several base stations on one frequency, you must use receivers that support the CMR + correction record format.

All other base and rover receivers must be Trimble R8, R7, R6, 5800, or 5700 GPS receivers, or 4700 or 4800 GPS receivers with firmware version 1.20 or later.

Note - Do not use transmission delays if you intend to use radio repeaters.

Starting the base with a transmission delay

When you use multiple base stations, you set the transmission delay for each base when you start the base survey. Each base must broadcast with a different transmission delay and station index number. The delays allow the rover to receive corrections from all of the base stations at once. The station index numbers let you select which base station to use at the rover.

Note - You can set the base radio transmission delay only when using Trimble R8, R7, R6, 5800, or 5700 GPS receivers, or 4700 or 4800 GPS receivers with firmware version 1.20 or later.

When you carry out surveys using different base stations in one job, make sure that the coordinates of the base stations are in the same coordinate system and are in terms of each other.

Before you start the base receiver, do the following:

1. Select the CMR + correction message format. Select this in the survey style for both the base and the rover.
2. Set the over air baud rate in the radio to at least 4800 baud.

Note - If you use a 4800 over air baud rate you can only use two base stations on one frequency. Increase the

over air baud rate if you want to increase the number of base stations on one frequency.

When you start the base survey, do the following:

1. In the *Station index* field, enter a value within the range 0-31. This number is broadcast in the correction message.

Tip - You can configure the default station index number in the survey style. For more information, refer to [Station index](#).

2. If the receiver you are using supports transmission delays, the *Transmission delay* field appears. Choose a value, depending on how many base stations you want to use. See the following table.

No. of base stations	Use these delays (in ms) ...			
	Base 1	Base 2	Base 3	Base 4
One	0	-	-	-
Two	0	500	-	-
Three	0	350	700	-
Four	0	250	500	750

For more information about starting the base survey, see [Starting a Base Survey](#).

For information about starting the rover and selecting which station index to use, see [Starting a Rover Survey](#).

Starting a Real Time Survey Using a Dial-in GSM connection

If you are receiving corrections from a single base station, do not start the survey until you have started the base receiver. For more information, see [Starting the Base Receiver](#).

To start the rover receiver for a real-time survey:

1. If you are using a cellular modem, make sure that the modem is switched on, then connect it to the receiver (or to the controller if you selected the [Route through SC](#) option).
2. If you are using a Trimble Internal GSM/GPRS module, make sure that the receiver is turned on and is connected to the controller.
3. From the main menu, select *Survey / (Selected Survey Style) / Start Survey*.
The message *Connecting to modem appears*. Once the connection is completed, the modem dials the base station or Wide Area RTK service provider.
Once the cellular modem or Trimble Internal GSM/GPRS module signals are received, and the corrections data link is established, the cellular phone icon appears on the status bar.

Tip - Select the *Prompt for dial profile* check box to display the dial profile that is configured in the

survey style, or change the dial profile when you start the survey.

To end the survey, select *Survey / (Selected Survey Style) / End survey*.
The modem hangs up during the end survey process.

Note – When you send initialization strings to the modem, if you see the error message "No response from modem", check that the strings you set in the survey style are valid for your particular modem. Some modems accept only upper case AT commands.

Note - To configure a Survey style for a real-time dial-in GSM survey see [Configuring a Survey Style for a Dial-in Real Time Survey](#).

Starting a Real Time Survey Using a GPRS internet connection

If you are receiving corrections from a single base station, do not start the survey until you have started the base receiver. For more information, see [Starting the Base Receiver](#).

To start the rover receiver for a real-time survey:

1. If you are using a cellular modem, make sure that the modem is switched on, then connect it to the receiver.
2. If you are using a Trimble Internal GSM/GPRS module, make sure that the receiver is turned on and is connected to the controller.
3. From the main menu, select *Survey / (Selected Survey Style) / Start Survey*.

The message "Establishing network connection" appears. Once the connection is completed, the modem receives corrections from the base station or Wide Area RTK service provider through the Internet connection.

Once the corrections data link is established, the radio icon appears on the status bar.

Tip - Select the *Prompt for dial profile* check box to display the dial profile that is configured in the survey style, or change the dial profile when you start the survey.

Note - To configure a Survey style for a real-time internet survey see [Configuring a Survey Style for an Internet Real Time Survey](#).

Note - When you start a survey with the controller already connected to the Internet, the existing connection is used for the base data. The Internet connection does not close when you end the survey.
When you start a survey with the controller not connected to the Internet, the controller will open an Internet connection using the connection specified in the Survey Style. This connection closes when you end the survey.

Redialing the Base Station

If you lose the phone connection during a GSM dial-in survey, use the Redial function to reconnect to the base station or [Wide Area RTK network](#).

Alternatively, you can hang up the modem using the Trimble Survey Controller software, continue the survey, and later redial the base to re-establish corrections.

To hang up and redial:

1. Tap the Cellular phone icon on the status bar. The *Rover radio* screen appears.
2. To hang up the modem, tap *Hang up*.
3. To redial the base station, tap *Redial*.

Note - When you redial a VRS service provider, a new base station position is sent through the data link. When the Trimble Survey Controller software switches to the new base, the survey continues with this new position.

Starting a Wide-Area RTK Survey

Wide Area RTK (WA RTK) systems consist of a distributed network of reference stations communicating with a control center to calculate GPS error corrections over a wide area. Real-time correction data is transmitted by radio or cellular modem to the rover receiver within the network area.

The system improves reliability and operating range by significantly reducing systematic errors in the reference station data. This lets you increase the distance at which the rover receiver can be located from the physical reference stations, while improving on-the-fly (OTF) initialization times.

The Trimble Survey Controller software supports broadcast formats from the following WA RTK solutions:

- SAPOS FKP
- Virtual Reference Station (VRS)
- RTCM3Net

To use a WA RTK system, first check that you have the necessary hardware and firmware.

Hardware Requirements

All rover receivers must have firmware that support WA RTK. For details of availability, check the Trimble website or contact your local dealer.

Real-time correction data is provided by radio or cellular modem. For details about the delivery option for your system, contact your local dealer.

Configuring the Survey Style

Before you start a survey using a WA RTK system, configure the RTK survey style.

To select a WA RTK broadcast format:

1. In the survey style, select *Rover options*.
2. In the *Broadcast format* field, select one of the following options from the list:
 - ◆ SAPOS FKP
 - ◆ VRS (RTCM)
 - ◆ VRS (CMR)
 - ◆ RTCM3Net

To store VRS vectors to the nearest Physical Base Station (PBS) in the VRS network, the VRS system must be configured to output the PBS information. If the VRS system does not output PBS data, VRS data must be stored as positions.

To select a radio solution:

1. In the survey style, select *Rover radio*.
2. In the *Type* field, select your radio from the list.

Note - If you are using a radio in a VRS system, you must select a two-way radio. You cannot use Trimble internal 450 MHz or 900 MHz radios.

RTK and Infill Survey

This type of survey allows you to continue a kinematic survey when radio contact is lost. The infill data must be postprocessed.

Configure an RTK and Infill survey when you create or edit a Survey Style.

To do this:

1. From the main menu, select *Configuration / Survey Styles / RTK & infill / Base options*.
2. In the *Survey type* field, select *RTK and infill*.
3. Specify the logging device and logging interval.
4. Do the same for *Rover options*.

To receive WAAS/EGNOS positions instead of autonomous positions when the radio is down, set the *Satellite differential* field to WAAS (North America) or EGNOS (Europe).

To receive GLONASS positions as well as GPS positions, select the *GLONASS* check box.

The logging interval is for the infill session only and should be the same for each receiver, typically 5 seconds. The RTK interval remains at 1 second.

When radio contact is lost, the following message flashes in the status line: 'Radio link down'.

To start infill:

1. From the main menu, select *Survey / RTK & infill / Start PP infill*.
2. Initialize, and continue as for a postprocessed kinematic survey.

When the radio link returns, select *Survey / Stop PP infill* from the main menu and continue with your RTK survey.

For more information, see:

[Rover Options](#)

[Base Options](#)

[Radio](#)

[Laser Rangefinder](#)

[Topo Point](#)

[Observed Control Point](#)

[Rapid Point](#)

[Continuous Points](#)

[Stakeout](#)

[Configuring the Survey Style for a Site Calibration](#)

[Duplicate Point Tolerance](#)

RTK and Data Logging

This type of survey records raw GPS data during an RTK survey.

As this survey style is not provided by the Trimble Survey Controller software, you must create the style the first time that you want to use it.

To do this:

1. From the main menu, select *Configuration / Survey Styles* and tap *New*.
2. Type in RTK and data logging and tap *Enter*.
3. Select *Base options*.
4. In the *Survey type* field, select *RTK and logging*.
5. Specify the logging device and the logging interval.

6. Repeat steps 4-6 for *Rover options*.

The logging interval should be the same for each receiver - typically 5 seconds. The RTK interval remains at 1 second.

To receive GLONASS positions as well as GPS positions, select the *GLONASS* check box.

For more information, see:

[Rover Options](#)

[Base Options](#)

[Radio](#)

[Laser rangefinder](#)

[Topo Points](#)

[Observed Control Point](#)

[Rapid Point](#)

[Continuous Topo Points](#)

[Stakeout](#)

[Configuring the Survey Style for a Site Calibration](#)

[Duplicate Point Tolerance](#)

FastStatic Survey

A FastStatic survey is a postprocessed survey using occupations of up to 20 minutes to collect raw GNSS data. The data is postprocessed to achieve sub-centimeter precisions. Typically, the occupation times vary based on the number of satellites. A minimum of four satellites is required.

Configure a FastStatic survey when you create or edit a Survey Style.

To do this:

1. From the main menu, select *Configuration / Survey Styles / FastStatic / Base options*.
2. In the *Survey Type* field select *FastStatic*.
3. Do the same for *Rover options*.

To receive GLONASS positions as well as GPS positions, select the *GLONASS* check box.

For more information, see:

[Rover Options](#)

[Base Options](#)

[Starting a rover survey](#)

[Laser Rangefinder](#)

[FastStatic Point](#)

[Duplicate Point Tolerance](#)

PPK Survey

Postprocessed Kinematic surveys store raw observations and process them later.

Configure a PPK survey when you create or edit a Survey Style.

To do this:

1. From the main menu, select *Configuration / Survey Styles / PPK / Base options*.
2. In the *Survey Type* field select *PP Kinematic*
3. Do the same for *Rover options*.

To store GLONASS positions as well as GPS positions, select the *GLONASS* check box.

Note - When logging PPK data to the controller with a Trimble R8 or R6 GNSS receiver, you must have receiver firmware version 3.30 or later installed. Otherwise, the message "Unsupported receiver firmware version" appears. If this occurs, upgrade the receiver firmware, or log the data to the receiver.

When you use this type of survey, the default logging interval is five seconds. If your receiver is capable of storing data, the first time that you use this survey style, the Style wizard prompts you to specify where you want to store the data.

Before you measure points, [initialize](#) the survey using one of the following methods:

- Known point
- New point
- On-The-Fly (OTF)

When you are familiar with the equipment, you can configure the PP initialization times.

For more information, see:

[Rover Options](#)

[Base Options](#)

[Starting a rover survey](#)

[Laser Rangefinder](#)

[FastStatic Point](#)

[Duplicate Point Tolerance](#)

PP Initialization Times

Select the *PP initialization times* survey style option to define initialization times. Generally the default settings are appropriate.

Warning - Reducing any of these times can affect the outcome of a postprocessed survey. Increase these times rather than decrease them.

The number of satellites required depends on whether you are using GPS satellites only, or a combination of GPS and GLONASS satellites. The following table summarizes the requirements.

Minimum L1/L2 satellites required for On-The-Fly initialization

Satellite Systems	GPS	GLONASS
GPS only	5	0
GPS + GLONASS	4	2
GPS + GLONASS	3	3
GPS + GLONASS	2	4
GLONASS only	N/A	N/A

Note - You cannot initialize if the DOP is greater than 20.

After initialization, a position can be determined and the initialization can be maintained with one satellite less than the number required to initialize. If the number of satellites drops below this number, the survey must be reinitialized.

The following table summarizes the requirements.

Minimum L1/L2 satellites required to maintain initialization and produce positions

Satellite Systems	GPS	GLONASS
GPS only	4	0
GPS + GLONASS	4	1

GPS + GLONASS	3	2
GPS + GLONASS	2	3
GPS + GLONASS	1	4
GLONASS only	N/A	N/A

After initialization, the survey mode changes from Float to Fixed. The mode remains Fixed if the receiver continuously tracks the minimum number of satellites. If the mode changes to Float, you must reinitialize the survey.

RT Differential Survey

This survey type uses a radio to broadcast a correction message (RTCM-104) from the base station to the rover which then calculates its position. A real-time differential survey gives sub meter level precisions.

Differential surveys require four satellites that are common to the base and the rover receivers. Differential surveys do not require initialization.

The two differential survey types are described in the following sections:

- RT differential - This survey uses the RTCM broadcast message and relies on a reliable radio for the duration of the survey. Alternatively, use WAAS/EGNOS signals to provide real-time positions instead of a radio.
- RT diff & logging - This survey works in the same way as an RT differential survey, except that data is recorded for the entire survey both at the base and at the rover receivers. This method is useful if raw data is required for quality assurance purposes.

As this survey style is not provided by the Trimble Survey Controller software, you must create the style the first time that you want to use it.

To do this:

1. From the main menu, select *Configuration / Survey Styles*.
2. Tap *New*.
3. Enter a name in the *Style name* field.
4. In the *Style type* field, choose *GPS* and tap *Accept*.
5. Choose *Rover options* or *Base options* and make the appropriate changes to the *Type* field. In this case, change it to the differential method that you want to use. The survey type you select depends on whether the technique you choose is real-time or postprocessed.
6. For both real-time and postprocessed techniques, define an elevation mask and antenna for the base and the rover. For the *Rover options*, define Broadcast format, the PDOP mask, and the RTCM age limit. In a differential survey you can choose to set the *Broadcast format* field to RTCM, WAAS (North America), or EGNOS (Europe).
7. For methods that involve data logging, specify whether the data is to be logged in the receiver or in the controller, and define the interval. For real-time techniques, the RTCM-SC104 version 2 broadcast message format is used. Real-time signals are generated at 1second intervals.

8. To use [Wide Area Augmentation System](#) positions when you do not have a radio, set the broadcast format to WAAS (North America) or EGNOS (Europe).
9. To receive WAAS/EGNOS positions instead of autonomous positions when the radio is down, set the broadcast format to RTCM and set the *Satellite differential* field to WAAS or EGNOS.

Note - For WAAS/EGNOS surveys, you must use a receiver that can track WAAS/EGNOS satellites.

For more information, see:

[Rover Options](#)

[Base Options](#)

[Radio](#)

[Laser rangefinder](#)

[Topo Points](#)

[Observed Control Point](#)

[Rapid Point](#)

[Continuous Topo Points](#)

[Stakeout](#)

[Configuring the Survey Style for a Site Calibration](#)

[Duplicate Point Tolerance](#)

Wide Area Augmentation System (WAAS) and European Global Navigation Overlay Service (EGNOS)

WAAS is a satellite-based delivery system for differential positions. It is available only in North America. The equivalent system in Europe is the European Global Navigation Overlay Service (EGNOS), and in Asia it is MSAS.

WAAS and EGNOS signals provide real-time, differentially corrected positions without the need for a radio link. You can use WAAS or EGNOS in real-time surveys when the ground-based radio link is down.

To use WAAS signals, in the *Rover options* screen of your survey style, set *Satellite differential* to WAAS or EGNOS, depending on your location.

In real-time differential surveys, you can set the broadcast format to WAAS or EGNOS to always store WAAS/EGNOS positions without the need for a radio link.

When WAAS/EGNOS signals are being received, the radio icon changes to a WAAS/EGNOS icon, and in an RTK survey, RTK:WAAS is displayed on the status line.

The availability of WAAS/EGNOS signals depends on your location and the receiver that you are using. See your Trimble dealer for details.

Rapid Point

This is a method for measuring real-time GPS points quickly. Configure this type of point when you create or edit a GPS Survey Style. The point is stored when the preset precisions have been satisfied. There is no minimum occupation time.

The Trimble Survey Controller software collects just one epoch of data when the preset precisions are reached, so the default precision values should ideally be higher than for other point measurement types. The software uses this single epoch of data to define the point, making Rapid point the least precise measurement method.

Alternatively, you can change the *Type* field to *Rapid point* in the *Measure points* screen, and tap *Options*.

In an RTK survey, when you select the *Auto tolerance* check box, the software calculates horizontal and vertical precision tolerances that meet the GPS receiver's RTK specifications for the baseline length you are measuring. If you want to enter your own precision tolerances, clear this check box.

To measure a Rapid point:

1. Do one of the following:
 - ◆ From the main menu, select *Survey / Measure points*.
 - ◆ Tap *Favorites* and select *Measure points*.
2. Enter values in the *Point name* and *Code* fields (the *Code* field entry is optional), and enter *Rapid point* in the *Type* field.
3. Enter a value in the *Antenna height* field and make sure that the setting in the *Measured to* field is set appropriately.
4. Tap *Measure* to start recording data. The point is automatically stored when the preset precisions are reached.

Continuous Topo

Use the continuous topo function to measure points continuously.

A point is stored when one of the following conditions occurs:

- a predefined time has elapsed
- a predefined distance has been exceeded
- both predefined time and/or distance settings have been met
- a predefined stop time and distance settings have been met

To configure the survey style for Continuous topo:

In an RTK survey, when you select the *Auto tolerance* check box, the software calculates horizontal and vertical precision tolerances that meet the GPS receiver's RTK specifications for the baseline length you are measuring. If you want to enter your own precision tolerances, clear this check box.

If you are doing a postprocessed survey, the time interval is the logging interval. Configure this logging interval in the *Rover options* screen of the postprocessed survey style.

To measure Continuous topo points:

1. From the main menu, select *Survey / Continuous topo*.
2. In the *Type* field, select *Fixed time*, *Fixed distance*, *Time and distance*, *Time or distance* or *Stop and go*.

Note - For a postprocessed survey, you can only use the *Fixed time* continuous method. The time interval is set by default to the same value as the logging interval.

3. Enter a value in the *Antenna height* field and make sure that the setting in the *Measured to* field is set appropriately.
4. Enter a value in the *Time interval* field, or the *Stop and go* field and/or the *Distance* field, depending on the method you are using.
5. To generate offsets, set the *Offset* field to *One* or *Two*. The *Fixed time* method does not support offsets.
6. Enter a value in the *Start point name* field (or enter a start point name for the center line when measuring offset points). This increments automatically.
7. If you are measuring an offset line, enter the offset distances and the start point name. To enter a left horizontal offset, enter a negative offset distance or use the *Left* or *Right* pop-up menus.
8. Tap *Measure* to start recording data, and then move along the feature to be surveyed.

When using the *Stop and go* method, enter a value in the *Stop time* field for the period of time the antenna must be stationary before the receiver starts to measure the point. The user is deemed to be stationary when their velocity is less than 5cm/sec.

Note - To change the distance interval, time interval, or offset while measuring points, enter new values in the fields.

9. To stop measuring continuous points, tap *End*.

Tip - To store a position before the predefined conditions have been met, tap *Store*.

FastStatic Point

This type of point is measured in a [FastStatic survey](#). Configure the preset times at which a FastStatic point is measured when you create or edit a FastStatic Survey Style - usually the default time is sufficient.

Note - If you do not record enough data, the points may not be successfully postprocessed.

The Trimble Survey Controller software terminates a FastStatic occupation automatically if the *Auto store point* check box is selected and the specified occupation time is satisfied.

The default occupation times are satisfactory for most users. If you change an occupation time, choose a setting according to the number of satellites being tracked by that receiver. Remember that both receivers must track the same satellite at the same time for the data to be useful.

Tip - Use a mobile phone or a walkie-talkie radio to verify that both receivers are tracking the same satellites.

Changing the occupation times directly affects the outcome of a FastStatic survey. Any changes should increase this time rather than decrease it.

You can only measure a FastStatic point in a FastStatic survey.

Note - FastStatic surveys are postprocessed and do not need to be initialized.

To measure a FastStatic point:

1. Do one of the following:
 - ◆ From the main menu, select *Survey / Measure points*.
 - ◆ Tap *Favorites* and select *Measure points*.
2. Enter values in the *Point name* and *Code* fields (the *Code* field entry is optional).
3. Enter a value in the *Antenna height* field and make sure that the setting in the *Measured to* field is set appropriately.
4. Tap *Measure* to start measuring the point.
5. When the preset occupation time is reached, as shown in the following table, tap *Store* to store the point.

Receiver type	4 SVs	5 SVs	6+ SVs
Single-frequency	30 min	25 min	20 min
Dual-frequency	20 min	15 min	8 min

Tip - No satellite tracking is necessary between measuring points. You can turn off the equipment.

Observed Control Point

This is a previously configured method of measuring and storing a point. Configure observed control points when you create or edit a Survey Style. The point is stored with a search classification of Normal.

The Trimble Survey Controller software can terminate observed control point measurements and store the results automatically if the *Auto store point* check box is selected and the occupation times are satisfied. For RTK surveys, the number of measurements and the horizontal and vertical precisions must also be satisfied. The default setting for the *Number of measurements* field is 180. The extended occupation time suggests that this measurement type is ideally suited to points that will be used for control purposes.

Note - When the *Auto store point* check box is cleared, tap *Store* when it appears on the *Enter* button to store the point. The *Enter* softkey is blank until the specified occupation time has been met. To store a point before that time has elapsed, tap *Enter*. When you do this, the Trimble Survey Controller software asks you to confirm storing the point. Tap *Yes* to store the point.

Quality control information is automatically stored with each point:

- Real-time observed control points can store QC1, QC1 & QC2, or QC1 & QC3 records.
- Postprocessed observed control points only store QC1 records.

If the *Topo point* option is configured to perform 180 measurements, the positional result is similar to a point measured using the observed control point measurement type. Differences are:

- the default value in the *Quality control* field
- the observation class given by the office software when the point is downloaded

When the Trimble Survey Controller software measures an observed control point, it stores a point when the preset number of epochs has elapsed and the precisions have been attained.

In an RTK survey, when you select the *Auto tolerance* check box, the software calculates horizontal and vertical precision tolerances that meet the GPS receiver's RTK specifications for the baseline length you are measuring. If you want to enter your own precision tolerances, clear this check box.

To measure an observed control point:

1. Do one of the following:
 - ◆ From the main menu, select *Survey / Measure points*.
 - ◆ Tap *Favorites* and select *Measure points*.
2. Enter values in the *Point name* and *Code* fields (the *Code* field entry is optional), and select *Observed control point* in the *Type* field.
3. Enter a value in the *Antenna height* field and make sure that the setting in the *Measured to* field is set appropriately.
4. Tap *Measure* to start recording data.
5. When the preset number of epochs and precisions are reached, tap *Store* to store the point.

Note - For an RTK survey, initialize the survey before starting to measure the point. For a Postprocessed Kinematic survey, you can start measuring a point, but you cannot store it until you have initialized the survey.

RTK On Demand

If you are using an Internet connection to send RTK data from the base to the rover, then you can use Trimble Survey Controller's RTK on Demand functionality to control the amount of data broadcast from the base receiver. You can request the base station to send data only when you require it. This will reduce the amount of data received by your cellular phone and may reduce costs from your cellular network service provider.

Once the RTK survey is running over an Internet connection, you can access the *RTK on Demand* controls by tapping the  icon in the status bar.

When the survey is started, Trimble Survey Controller will default to Play  mode. When in Play mode, RTK data will be streamed continuously.

If you tap the  softkey, your survey will go into Pause mode and data will only be streamed when required. Trimble Survey Controller will request data from the base station when initialization is lost, or when you choose to measure a point, or when you start continuous topo, or when you use the stakeout functionality. As soon as the receiver has regained initialization, or the survey task is complete, then Trimble Survey Controller will request the base station to stop streaming data.

If you tap the  softkey then your survey will go into Stop mode and no RTK data will be streamed. This can be used in situations where you do not wish to end your survey, but do not require the receiver to stay initialized until you are ready to start surveying again.

Hardware requirements

The RTK on Demand functionality requires an Internet connection at both the GPS base station and rover. This means that you will require two cellular phones, either GPRS capable or GSM connected to a dial-up Internet connection. Either Trimble Survey Controller is required to be at both the GPS base station and rover (this means that you will require two Trimble Controllers running Trimble Survey Controller version 11.00 or later), or you must be connected to a Trimble GPSNet or GPSBase infrastructure system.

Survey - Integrated

Integrated Surveys

Using an Integrated Survey (IS) allows you to connect to both a GPS receiver and a conventional instrument at the same time.

You can perform an integrated survey using Trimble VX/S Series or Trimble 5600 instruments and RTK surveys.

For more information, see:

- [Configuring an integrated survey style](#)
- [Starting an integrated survey](#)
- [Switching between instruments](#)
- [Ending an integrated survey](#)
- [Using an IS rover survey rod](#)

Configuring an integrated survey style

An integrated survey style is created by referencing a conventional survey style and an RTK survey style, and then providing additional information specific to the integrated survey.

To configure an integrated survey style:

1. From the main menu, select *Configuration / Survey Styles* and then tap *New*.
2. Enter the *Style name*, set the *Style type* to *Integrated Surveying* and then tap *Accept*.
3. Select the *Conventional* and *GPS* styles you want to reference for the integrated style and then tap *Accept*.

To configure the [IS rover survey rod](#), continue with the next step.

4. Tap *Target options*.
5. Select the *IS rover* check box and then enter the *Prism to antenna offset*.

Note - When the *IS rover* option is enabled, the only way to change the GPS antenna height in an integrated survey is to use Target 1 and enter the height to the **prism**. The GPS antenna height is computed automatically using the *Prism to antenna offset* configured in the IS style.

Starting an integrated survey

There are a number of ways to start an integrated survey. Use the method that best suits the way you work:

- Start a conventional survey and then start a GPS survey at a later time.
- Start a GPS survey and then start a conventional survey at a later time.
- Start an integrated survey. This starts a conventional survey and a GPS survey at the same time.

To start an integrated survey, first create an [integrated survey style](#), and then select *Survey / <integrated survey style name>*.

To start a single survey, and then start an integrated survey at a later time, begin your first survey as usual and then select *Survey / Integrated surveying*. Only the styles that are configured in the integrated survey style are available in an integrated survey.

Tip - When using an integrated survey you can measure points using GPS during a Resection and Station Setup Plus.



Switching between instruments

In an integrated survey, the controller is connected to both devices at the same time. This makes switching between instruments very quick.

To switch from one instrument to another, do one of the following:

- Tap the Status line
- Select *Survey / Switch to <style name>*
- Tap *Switch to* and then select *Switch to <style name>*
- On the TSC2 controller, [customize](#) the [Left App] button or the [Right App] button to *Switch to TS/GPS* and then tap the [App] button.

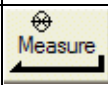
In an integrated survey, identify the instrument that is currently 'active' by looking at the Status bar, the Status line, or the *Enter* softkey.

Active survey	Example status line	Enter softkey
Conventional	HA:45°56'21" VA:87°32'34"	
GPS	RTK:Fixed H:0.019 V:0.024 RMS:043	

When you use the Trimble Survey Controller software in an integrated survey, there are some areas of functionality within the Trimble Survey Controller software where you cannot switch instruments. For example, you cannot switch instruments if the current screen is stakeout line or arc, or if you are in the stakeout points **graphics** screen.

For more information on how the different features behave, and the way to switch the feature to use the active instrument see the following sections:

Measure topo / Measure points

- If you switch instruments during an integrated survey when you are using Measure topo (conventional), the software automatically switches you to the Measure points (GPS) screen (and vice versa).
- The **point name** defaults to the next available name.
- The **code** defaults to the last **stored** code.

- Switch instruments before you change the point name and code. If you enter a point name or code before switching instruments, they will not be the default after the switch.

Measure codes

- When you switch instruments, the active instrument is used for the next observation.

Continuous topo

- Only one Continuous topo survey is possible at one time.
- You cannot switch the instrument used in Continuous topo while Continuous topo is running.
- To change the instrument that is being used in Continuous topo, tap *Esc* to **exit** Continuous topo and then restart Continuous topo.
- You can switch instruments if the Continuous topo screen is open but running in the background. If you switch instruments when the Continuous topo screen is running in the background, and you later make the Continuous topo screen the active screen, the Trimble Survey Controller software automatically switches to the instrument with which you started Continuous topo.

Stakeout Points

- Only one Stakeout point survey is possible at one time.
- You cannot switch the instrument used in Stakeout points when the Stakeout points **graphics** screen is displayed.
- To change the instrument that is being used in Stakeout points, tap *Esc* to return to the *Stake out point* list, switch instruments and then tap *Stakeout*.
- You can switch instruments if the Stakeout graphics screen is open but running in the background. If you switch instruments when the Stakeout graphics screen is running in the background, and you later make the Stakeout graphics screen the active screen, the Trimble Survey Controller software automatically switches to the instrument with which you started Stakeout points.

Stakeout Lines

- Only one Stakeout line survey is possible at one time.
- You cannot switch the instrument used in Stakeout lines when the Stakeout lines screen is displayed.
- To change the instrument that is being used in Stakeout lines, tap *Esc* to exit Stakeout lines, switch instruments and then restart Stakeout lines.
- You can switch instruments if the Stakeout lines screen is open but running in the background. If you switch instruments when the Stakeout lines screen is running in the background, and you later make the Stakeout lines screen the active screen, the Trimble Survey Controller software automatically switches to the instrument with which you started Stakeout lines.

Stakeout Arcs

- Only one Stakeout arc survey is possible at one time.
- You cannot switch the instrument used in Stakeout arcs when the Stakeout arcs screen is displayed.
- To change the instrument that is being used in Stakeout arcs, tap *Esc* to exit Stakeout arcs, switch instruments and then restart Stakeout arcs.

- You can switch instruments if the Stakeout arcs screen is open but running in the background. If you switch instruments when the Stakeout arcs screen is running in the background, and you later make the Stakeout arcs screen the active screen, the Trimble Survey Controller software automatically switches to the instrument with which you started Stakeout arcs.

Stakeout Alignments

- Only one Stakeout alignment survey is possible at one time.
- You cannot switch the instrument used in Stakeout alignments when the Stakeout alignments **graphics** screen is displayed.
- To change the instrument that is being used in Stakeout alignments, tap *Esc* to return to the *Stake out alignment* screen, switch instruments and then tap *Start*.
- You can switch instruments if the Stakeout graphics screen is open but running in the background. If you switch instruments when the Stakeout graphics screen is running in the background, and you later make the Stakeout graphics screen the active screen, the Trimble Survey Controller software automatically switches to the instrument with which you started Stakeout alignments.

Stakeout Roads

- Only one Stakeout road survey is possible at one time.
- You cannot switch the instrument used in Stakeout roads when the Stakeout roads **graphics** screen is displayed.
- To change the instrument that is being used in Stakeout roads, tap *Esc* to return to the *Stake out road* screen, switch instruments and then tap *Start*.
- You can switch instruments if the Stakeout graphics screen is open but running in the background. If you switch instruments when the Stakeout graphics screen is running in the background, and you later make the Stakeout graphics screen the active screen, the Trimble Survey Controller software automatically switches to the instrument with which you started Stakeout roads.

Ending an integrated survey

To end an integrated survey, you can end each survey individually, or select *End integrated survey* to end the GPS survey and the conventional survey at the same time.

IS rover - Integrated survey rod

When surveying with an integrated survey style you can use an IS rover survey rod.

For more information, see:

- [Configuring an IS rover](#)
- [Using an IS rover survey rod](#)

Configuring an IS rover

The IS rover survey rod is configured as part of the [integrated survey style](#).

When you configure the IS rover survey rod, enter the *Prism to antenna offset*. The offset is measured from the center of the prism to the position on the GPS antenna. The position on the GPS antenna is defined in the *Rover options* form of the GPS survey style which is referenced by the integrated survey style.

The following table shows the offset distance from the center of the prism to the Trimble R8 antenna:

Prism type	Offset measured to bottom of antenna mount	Offset measured to center of bumper
VX/S Series MultiTrack	34 mm	90 mm
VX/S Series 360°	57 mm	113 mm
RMT606	33 mm	87 mm

Note - If an incorrect antenna measurement method is set, the incorrect offset is applied to the GPS antenna heights.

Using an IS rover survey rod

In an integrated survey you must enable *IS rover* and use Target 1 to update the GPS height automatically. When the *IS rover* option is enabled, a change to the conventional target height applies the *Prism to antenna offset* configured in the IS style and automatically updates the GPS antenna height.

To change the IS rover height:

1. Ensure that *IS rover* is enabled in the IS style, and that the *Prism to antenna* offset has been correctly configured and applies to the antenna *Type* and *Measured to* setting configured in the RTK style.
2. Tap the target or antenna icon in the status bar.
 - ◆ In a conventional survey, select *Target 1*.
 - ◆ In a GPS survey, *Target 1* is automatically selected for you.
3. Enter the *Target height* (the height to the center of the prism).

The updated height is not displayed in the Status bar until the target form is closed.

4. Tap *Antenna* to see the entered target height, style configured prism to antenna offset, and computed antenna height. This step is optional.
5. Tap *Accept*.

If you do not select the *IS rover* check box, changes to the target heights are not automatically applied to the GPS antenna height.

This means that when you change the conventional target height, you must also change the GPS antenna height.

Survey - Stakeout

Stakeout - Configuring the Display Mode

The display varies depending on whether you are performing a [Conventional](#) or [GPS](#) survey.

Conventional Surveys

For a conventional survey the [Stakeout graphical display](#) screen displays directions using the conventional instrument as a reference point.

For a conventional survey, you can configure the *Stakeout directions* and the *Display mode* of the [Stakeout graphical display](#).

Stakeout directions allows you to configure the stakeout directions to be from an instrument perspective, target perspective, or automatic. *Automatic* configuration sets the stakeout directions automatically, based on whether you have a servo connection or a robotic connection to the instrument.

Display mode allows you to configure the graphical navigation display.

When the *Display mode* is set to *Direction and distance*, the navigation screen displays:

- ◆ A large arrow pointing in the direction you have to move. When you are close to the point, the arrow changes to the in/out and left/right directions, relative to the instrument.

When the *Display mode* is set to *In/out and left/right*, the navigation screen displays:

- ◆ In/out and left/right directions, with the conventional instrument as a reference point.

To configure the display:

1. From the main menu, select *Configuration / Survey styles / <style name> / Stakeout*.
2. Set the *Stakeout directions*:
 - ◆ Automatic - navigation directions are from *Instrument perspective* (during a servo connection), or *Target perspective* (during a robotic survey).
 - ◆ Instrument perspective (standing behind the instrument) - in/out and left/right navigation directions given from an instrument perspective, looking from the instrument towards the target.
 - ◆ Target perspective (standing at the target) - in/out and left/right navigation directions given from a target perspective, looking from the target towards the instrument.
3. Set the *Display mode*:
 - ◆ Direction and distance - navigate using the large arrow, similar to GPS stakeout. When you are close to the point, the display automatically changes to the in/out and left/right display.
 - ◆ In/out and left/right - navigate using in/out and left/right directions, with the instrument as a reference point.

4. Choose a setting in the *Deltas* field. The options are:
 - ◆ Distances - navigate to a point using distances only
 - ◆ Delta grid - navigate to a point using delta grid values
 - ◆ Station and offset - navigate to a point using station and offset when staking a line or arc.

When staking to the line or arc the station and offset view displays the Station, H.offset, V.dist and the Grade.

When staking to the Station on the line / arc or the Station/offset from line / arc the view displays the Station, H.offset, V.dist, delta Station and delta H.offset.

5. Use the *Distance tolerance* field to specify the allowable error in distance. If the target is within this distance from the point, the graphical stakeout display indicates that the distance(s) is correct.
6. Use the *Angle tolerance* field to specify the allowable error in angle. If the conventional instrument is turned away from the point by less than this angle, the graphical stakeout display indicates that the angle is correct.
7. If a DTM file has been transferred into the Trimble Survey Controller software, you can select the *Display cut/fill to DTM* check box, and the graphical display screen will display the cut or fill relative to that DTM. Use the *DTM* field to specify the name of the DTM to be used. If necessary, specify a vertical offset to raise or lower the DTM.

Alternatively, tap *Options* from the *Stakeout* screen to configure the settings for the current survey.

GPS Surveys

For a real-time GPS surveys, you can set the mode of the *Stakeout graphical display* so that the point stays fixed in the center of the screen, or so that your position stays fixed in the center of the screen.

To configure the display:

1. From the main menu, select *Configuration / Survey styles / <style name> / Stakeout*.
2. In the *Display mode*, select either *Target centered*, or *Surveyor centered*.
3. You can enter a value in the *Zoom factor* field. This is the amount that the display zooms in when you switch from Coarse mode to Fine mode while navigating to a point. The default value is 4.0. When you zoom in by this amount, the width of the graphical display corresponds to approximately one meter (or three feet).
4. Select the *Auto change to Fine* option to automatically change to fine mode when you get within 1 foot (0.3048m) of the point.
5. Choose a setting in the *Deltas* field. The options are:
 - ◆ Azimuth and distance - navigate to a point using azimuth and distance
 - ◆ Delta grid - navigate to a point using delta grid values
 - ◆ Station and offset - navigate to a point using station and offset

When staking To the line or arc the station and offset view displays the Station, H.offset, V.dist and the Grade.

When staking to the Station on the line or arc, or the Station/offset from line or arc the view displays the Station, H.offset, V.dist, delta Station and delta H.offset.

6. If a DTM file has been transferred into the Trimble Survey Controller software you can select the *Display cut/fill to DTM* check box, and the graphical display screen will display the cut or fill relative to that DTM. Use the *DTM* field to specify the name of the DTM to be used. If necessary, specify a vertical offset to raise or lower the DTM.

Alternatively, tap *Options* from the *Stakeout* screen to configure the settings for the current survey.

Stakeout - Using the Graphical Display

The graphical display in *Stakeout* helps you to navigate to a point. The display orientation assumes you are moving forwards at all times. The display varies depending on whether you are performing a **Conventional** or **GPS** survey.

When you stake out a road, a **cross-section** view is also available.

Conventional

To use the graphical display in a conventional survey:

If you are using the *Direction and distance* mode:

1. Hold the display screen in front of you as you walk forwards in the direction that the arrow is pointing. The arrow points in the direction of the point.
2. When you get to within 3 meters (10 feet) of the point, the arrow disappears, and the in/out and left/right directions appear, with the instrument as a reference point. Follow the instructions below to navigate in this mode.

If you are using the *In/out and left/right* mode:

1. The first display shows which way the instrument should be turned, the angle that the instrument should display and the distance from the last point staked to the point currently being staked.
2. Turn the instrument (two outline arrows will appear when it is on line), and direct the rod person on line.

If you are using a servo instrument, and the *Servo auto turn* field in the survey style is set to *HA & VA*, or *HA only* the instrument automatically turns to the point.

If you are working robotically, or when the *Servo auto turn* field in the survey style is set to *Off*, the instrument does not turn automatically. To turn the instrument to the angle indicated on the screen, tap *Turn*.

3. If the instrument is not in *TRK* mode, tap *Measure* to take a distance measurement.
4. The display shows how far the person holding the rod should move towards or away from the instrument.
5. Direct the person holding the rod, and take another distance measurement.
6. Repeat steps 2 - 5 until the point has been located (when four outline arrows are displayed), then

mark the point.

7. If a measurement to the target is within the angular and distance tolerances, tap *Store* at any time to accept the current measurement.

If the instrument is in TRK mode and you require a higher precision distance measurement, tap *Measure* to take an STD measurement and then tap *Store* to accept that measurement.

To discard the STD measurement and return the instrument to TRK mode, tap *Esc*.

If you are operating a robotic instrument remotely from the target:

- ◆ the instrument automatically tracks the prism as it moves
- ◆ the instrument continuously updates the graphical display
- ◆ the graphical display is reversed and the arrows are shown from the target (prism) to the instrument

GPS

When you use the graphical display in a GPS survey to navigate to a point, the screen first displays a large navigation arrow when you are some distance away from the point ("coarse navigation mode") and then automatically changes to a bull's-eye target as you move in closer.

- The arrow assumes that you are moving forward at all times.
- The bull's eye target does not assume that you are moving forward.

To use the graphical display in a GPS survey:

1. Hold the display screen in front of you as you walk forwards in the direction that the arrow is pointing. The arrow points in the direction of the point that you intend to measure.
2. When you get to within 10 feet (3 meters) of the point, the arrow disappears and a bull's-eye target appears.

When the bull's-eye target is displayed, do not change your orientation. Keep facing in the same direction and only move forwards, backwards, left or right.

3. When you get even closer to the point, tap *Fine* to make the screen zoom in.

Select the *Auto change to fine* option to automatically change to fine mode when you get within 1 foot (0.3048m) of the point.

4. Continue moving forwards until the cross, representing your current position, covers the bull's-eye target, representing the point. Mark the point.

Stakeout - Options

Configure the stakeout settings when you create or edit a Survey Style.

Select *Stakeout* and set the *As-staked point details*, *Stakeout display mode*, and *Available Station* options.

The *Available station* option is only available in *Road stakeout*.

If you want a 5D string in a GENIO file to be treated as a 3D string, clear the *Auto side slope* check box. See [Stakeout GENIO roads](#).

If you do not want the total station EDM set to *TRK* mode when you enter stakeout, clear the *Use TRK for stakeout* check box.

Alternatively, tap *Options* from the *Stakeout* screen to configure the settings for the current survey.

If you do not want the point removed from the stake out point list after it has been staked, clear the *Remove staked point from list* check box.

As-Staked Point Details

Configure the *As-staked point* details either in the *Stakeout* option, when you create or edit a survey style, or by tapping *Options* in the *Stakeout* screen.

You can configure the [View before storage](#) , [Horizontal tolerance](#) , [Staked deltas format](#) , [As-staked name](#) , [As-staked code](#) , and [Store grid deltas](#) .

View before storage and Horizontal tolerance

If you want to see the differences between the design point and the as-staked point before you store the point, select the *View before storage* check box and then choose one of these options:

- To see the differences every time, set the Horizontal tolerance to 0.000 m.
- To see the differences only if the tolerance is exceeded, set the Horizontal tolerance to 0.100 m.

Note - The *Stake delta* values are reported as differences **from** the measured/as-staked point **to** the design point.

User definable stakeout reports

The Trimble Survey Controller software supports user definable stakeout reports, which enable you to configure the display of staked information on the *Confirm staked deltas* screen that appears when you enable *View before storage*.

User definable stakeout reports can offer the following benefits:

- important information can be displayed first
- the data can be ordered to suit the user's requirements
- information that is not required can be removed
- additional data can be computed for display, for example by applying construction offsets to reported values
- for point stakeout, the point design elevation can be edited after the stakeout measurement is

completed

- for point stakeout, up to 10 extra design elevations with individual vertical offset values can be defined and edited, with the cut/fill to each extra design elevation being reported

Formatting of the staked deltas screen also supports the following settings:

- the size of the font for prompts
- the size of the font for reported values
- the color of the font for prompts
- the color of the font for reported values
- widescreen on or off

The content and format of the stakeout reports is controlled by XSLT style sheets. Translated default XSLT Stakeout Style Sheet (*.sss) files are included with the language files, and accessed by the Trimble Survey Controller software from the language folders. You can create new formats in the office and then use Microsoft ActiveSync technology to copy them to the *Trimble Data* folder on the controller.

From the *Staked deltas format* field, select an appropriate display format.

The following list shows the translated stakeout reports that are supplied with the language files, and the support offered by those reports:

- Point - Stake markup
 - ◆ Provides a simplified stakeout display that presents the vertical distance (cut/fill) to the design point. The vertical distance to a DTM will also be displayed if applicable.
- Point - Stake multiple elevs
 - ◆ Provides a stakeout display that allows you to edit the point design elevation (the cut/fill value will be updated) and entry of up to two extra design elevations with associated vertical offsets and updated cut/fill values.
- Line - Stake markup
 - ◆ Provides a simplified stakeout display that presents the vertical distance (cut/fill) to the design position. The appropriate station and offset values are reported, based on the selected line stakeout method.
- Arc - Stake markup
 - ◆ Provides a simplified stakeout display that presents the vertical distance (cut/fill) to the design position. The appropriate station and offset values are reported, based on the selected arc stakeout method.
- DTM - Stake markup
 - ◆ Provides a simplified stakeout display that presents the vertical distance (cut/fill) to the DTM being staked.
- Road - Catch + offsets
 - ◆ Provides details of all the standard road staked deltas plus a list of the horizontal and vertical distances to each of the cross-section positions from the staked offset position. The reported horizontal and vertical distances include the applied horizontal and vertical construction offsets.
- Road - Stake markup
 - ◆ Provides a simplified stakeout display that presents the vertical distance (cut/fill) to the road design position. Appropriate station and offset values and cross-section details (in the case of

- catch point staking) are reported, based on the road stakeout method.
- Road - XS details
 - ◆ Provides all the standard road staked deltas details as well as a list of the cross-section elements (left and right) that define the design cross-section at the selected station.

Tip - When you use multiple Stakeout Style Sheet files, Trimble recommends that you set the Staked deltas format from the *Configuration / Survey Styles* menu, where you can configure unique formats for Points, Lines, Arcs, DTMs, and Roads. You can also select the format within *Options* during stakeout.

Note - The development of the XSLT style sheets is an advanced procedure recommended for users with programming experience. For more information, please refer to the *Trimble Survey Controller software CD*.

As-staked name and As-staked code

You can set the **name** of the As-staked point to be one of the following:

- the next *Auto point name*
- the *Design point name* (not available for roads)

You can also set the **code** of the As-staked point to be one of the following:

- *Design name*
- *Design code*
- *Last code used*
- *Design station and offset*

The **Description** defaults as follows:

- When staking a point, line or arc with descriptions, the description of the as-staked point will default to the description of the design entity unless the *As-staked code* is set to *Last code used* in which case the the last used description is used.
- When staking a road the description will always be the last used independent of the the *As-staked code* setting.

Store grid deltas

Set the *Store grid deltas* check box. Do one of the following:

- Select the check box to display and store the delta northing, delta easting, and delta elevation during stakeout.
- Clear the check box to display and store the deltas as a horizontal distance, vertical distance, and azimuth.

Note - If you use a user definable stakeout report, the *Store grid deltas* option is not used, unless it is referenced in your report.

Stakeout - Points

To stake out a point:

1. From the map, select the point(s) to be staked out. Tap *Stakeout*.

If you have selected more than one point from the map for staking out, the *Stake out points* screen appears. Go to the next step. If you have selected one point from the map, go to step 4.

Tip - To stake out a point, double tap it on the map.

2. The *Stake out points* screen lists all points selected for stakeout. To add more points to the list, do one of the following:
 - ◆ Tap *Map* and then select the required points from the map. Tap *Stakeout* to return to the *Stake out points* screen.
 - ◆ Tap *Add*.

Choose the method to select points:

- Use the *Select from list* option to select from a list of all points in the Trimble Survey Controller database.
- Use the *Select from file* option to select points in a linked file

Notes

- ◇ When you add points to the stakeout list using the *Select from file* option, you can now add them from the linked file even if the point in the linked file already exists in the current job. The *Select from file* option is the only way you can stake a point from a linked file when a point of the same name exists in the current job.
- ◇ If a linked job contains two points of the same name, the point with the higher class is displayed.

3. To select a point for stakeout, highlight the point from the *Stake out points* screen and tap *Stakeout*. The *Stake out point* screen appears.
4. In the *Stake* field, select one of the following methods for staking out the point:
 - ◆ *To the point* - stake out the point with directions from your current position.
 - ◆ *From fixed point* - stake out the point with cross-track information and directions from another point. Enter a point name in the *From point* field. Select from a list, key in, or measure this value.
 - ◆ *From start position* - stake out the point with cross-track information and directions from the current position when you start to navigate.
 - ◆ *From last point staked* - stake out the point with cross-track information and directions from the last point that was staked out and measured. The **staked** point is used, not the design point.

To stake out from the current position, access the *From point* field and tap *Null*.

Note - The cross-track function creates a line between the point to be staked out and one of the following: a fixed point, the start position, or the last point staked. The Trimble Survey

Controller software displays this line, and an extra field in the graphical stakeout screen gives the offset to the line. The extra field is *Go left* or *Go right* .

5. In a GPS survey, enter a value in the *Antenna/Target height* field and make sure the setting in the *Measured to* field is set appropriately. The graphical display screen appears.

In a conventional survey, tap the Target icon to change target details.

The screen displays the angle to which you should turn the instrument and the distance from the instrument to the point, together with a graphical representation of this.

6. Locate the point using the [graphical display](#), and then mark it.

If required, edit the design elevation.

Note - The design elevation appears in the bottom right corner of the navigation window. To edit the elevation, tap the arrow. To reload an edited elevation, select *Reload original elevation* from the pop-up menu in the *Design elevation* field.

If the navigation window contains five rows of navigation information, the label for the *Design elevation* field is not shown.

7. When the point has been marked, you can measure it as an as-staked point by tapping *Accept* or *Measure*.

Stakeout - Lines

To stake out a line in an RTK or conventional survey:

1. Do one of the following:

- ◆ From the map, select two points to define a line, tap and hold and then select *Stake out line*.
- ◆ From the map, select the line to be staked out. Tap *Stakeout*, or tap and hold on the map and then select *Stake out line* from the shortcut menu.
- ◆ From the main menu, select *Survey / Stakeout / Lines*. Enter the name of the line to be staked out.

Tip - In the *Line name* field (or the *Start point* or the *End point* field) use the advanced pop-up arrow to select staking either a keyed-in line or one defined from two points.

2. In the *Stake* field, select one of the following options:

- *To the line*
- *Station on the line*
- *Station/offset from line*
- *Slope from line*

3. Enter the *Antenna/Target height*, the value of the station to be staked out (if any), and any further details, such as horizontal and vertical offsets. Tap *Start*.
4. Use the [graphical display](#) to navigate to the point.

5. Mark the point.
6. When the point has been marked, tap *Measure* to open the *Measure points* screen. Measure the point as an as-staked point.

To the line

Use this option, as shown in the diagram below, to stake out points on a defined line starting with the closest point (1) from your current position (2).

To stake out a line using the *To the line* method:

1. Do one of the following:
 - ◆ From the map, select the line to be staked out. Tap *Stakeout*, or tap and hold on the map and select *Stake out line* from the shortcut menu.
 - ◆ From the main menu, select *Survey / Stakeout / Lines*. Enter the line name.

Tip - To stake out a line, double tap it on the map.

2. In the *Stake* field, select *To the line*.
3. Enter the antenna/target height and tap *Start*.
4. Use the graphical display to navigate to the point.
5. Mark the point and tap *Measure* to measure it.

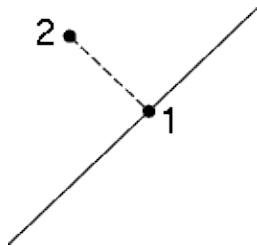

Station on the line

Use this option, as shown in the diagram below, to stake out stations (1) on a defined line at the stationing intervals (2) along the line.

To stake out a line using the *Station on the line* method:

1. Do one of the following:
 - ◆ From the map, select the line to be staked out. Tap *Stakeout*, or tap and hold on the map and select *Stake out line* from the shortcut menu.
 - ◆ From the main menu, select *Survey / Stakeout / Lines*. Enter the line name.
2. In the *Stake* field, select *Station on the line*.
3. Enter the antenna/target height and the station to be staked out and tap *Start*.
4. Use the graphical display to navigate to the point.
5. Mark the point and tap *Measure* to measure it.



Station/offset from line

Use this option, as shown in the diagram below, to stake out points (1) perpendicular to stations (3) on a defined line (2) and offset to the left or right by a set distance (4).

To stake out a line using the *Station/offset from line* method:

1. Do one of the following:
 - ◆ From the map, select the line to be staked out. Tap *Stakeout*, or tap and hold on the map and select *Stake out line* from the shortcut menu.
 - ◆ From the main menu, select *Survey / Stakeout / Lines*. Enter the line name.
2. In the *Stake* field, select *Station/offset from line*.
3. Enter the antenna/target height and the station to be staked out.
4. Specify the *Horizontal offset* (a negative value is left of the line) and the *Vertical offset* and tap *Start*.
5. Use the graphical display to navigate to the point.
6. Mark the point and tap *Measure* to measure it.

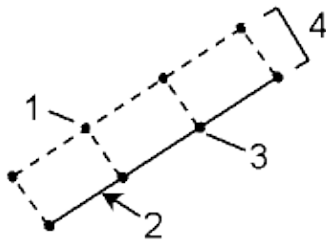

Slope from line

Use this option, as shown in the diagram below, to stake out points on surfaces (2), at different defined grades (3), either side of the defined line (cross section =1). See the diagram below.

To stake out a line using the *Slope from line* method:

1. Do one of the following:
 - ◆ From the map, select the line to be staked out. Tap *Stakeout*, or tap and hold on the map and select *Stake out line* from the shortcut menu.
 - ◆ From the main menu, select *Survey / Stakeout / Lines*. Enter the line name.
2. In the *Stake* field, select *Slope from line*.

Use the *Slope left* field and the *Slope right* field to define the type of grade in one of the following ways:

- ◆ horizontal and vertical distance
 - ◆ grade and slope distance
 - ◆ grade and horizontal distance
3. Enter the antenna or target height, specify the grade of the left and right slopes and tap *Start*.
 4. Use the graphical display to navigate to the point.
 5. Mark the point and tap *Measure* to measure it.

At any point on the surface, the display shows the closest station, the Horizontal offset, and the Vertical distance as a cut (4) or a fill (5).

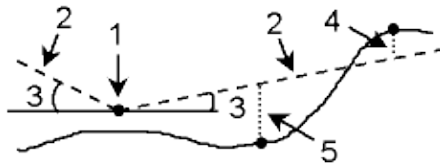

Tip - When selecting a line or arc to stakeout, tap near the end of the line or arc that you want to designate as the start of the line or arc. Arrows are then drawn on the line or arc to indicate the direction.

If the direction of the line or arc is incorrect, tap the line or arc to deselect it and then tap it at the correct end to reselect the line or arc in the direction required.

Note - The offset directions are not swapped when the line direction is reversed.

Stakeout - Arcs

Follow these steps to stake out an arc in an RTK or conventional survey:

1. Do one of the following:
 - ◆ From the map, select the arc to be staked out. Tap *Stakeout*, or tap and hold on the map and select *Stakeout* from the shortcut menu.
 - ◆ From the main menu, select *Survey / Stakeout / Arcs*. Enter the name of the arc to be staked out.

Tip To stake out an arc, double tap it on the map.

2. In the *Stake* field, select one of the following options:
 - ◆ *To the arc*
 - ◆ *Station on the arc*
 - ◆ *Station/offset from arc*
 - ◆ *Slope from arc*
 - ◆ *Intersect point of arc*
 - ◆ *Center point of arc*

3. Enter the antenna/target height and the value of the station to be staked out (if any).
4. Enter any further details, such as horizontal and vertical offsets, and tap *Start*.
5. Use the [graphical display](#) to navigate to the point.
6. Mark the point.
7. When the point is marked, tap *Measure* to open the *Measure points* screen. Measure the point as an as-staked point.

To the arc

Use this option, as shown in the diagram below, to stake out points on a defined arc, starting with the closest point (1) from your current position (2).

To stake out an arc using the *To the arc* method:

1. Do one of the following:
 - ◆ From the map, select the arc to be staked out. Tap *Stakeout*, or tap and hold on the map and select *Stakeout* from the shortcut menu.
 - ◆ From the main menu, select *Survey / Stakeout / Arcs*. Enter the arc name.
2. In the *Stake* field, select *To the arc*.
3. Enter the antenna/target height and then tap *Start*.
4. Use the graphical display to navigate to the point.
5. Mark the point and tap *Enter* to measure it.

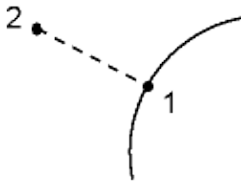

Station on the arc

Use this option, as shown in the diagram below, to stake out points (1) on a defined arc at the stationing intervals (2) along the arc.

To stake out an arc using the *Station on the arc* method:

1. Do one of the following:
 - ◆ From the map, select the arc to be staked out. Tap *Stakeout* or tap and hold on the map and select *Stakeout* from the shortcut menu.
 - ◆ From the main menu, select *Survey / Stakeout / Arcs*. Enter the arc name.
2. In the *Stake* field, select *Station on the arc*.
3. Enter the antenna/target height and the station to be staked out and tap *Enter*.
4. Use the graphical display to navigate to the point.
5. Mark the point and tap *Measure* to measure it.



Station/offset from arc

Use this option, as shown in the diagram below, to stake out points (1) perpendicular to stations (3) on a defined arc (2) and offset to the left or right by a specified distance (4).

To stakeout an arc using the *Station/offset from arc* method:

1. Do one of the following:
 - ◆ From the map, select the arc to be staked out. Tap *Stakeout*, or tap and hold on the map and select *Stakeout* from the shortcut menu.
 - ◆ From the main menu, select *Survey / Stakeout / Arcs*. Enter the arc name.
2. In the *Stake* field, select *Station/offset from arc*.
3. Enter the antenna/target height and the station to be staked out.
4. Specify the *Horizontal offset* (a negative value is left of the arc) and the *Vertical offset* and tap *Start*.
5. Use the graphical display to navigate to the point.
6. Mark the point and tap *Measure* to measure it.

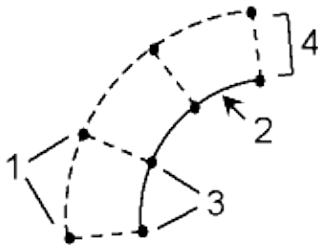

Slope from arc

Use this option, as shown in the diagram below, to stake out points on surfaces (2), at different defined grades (3) either side of the defined arc (cross section=1).

To stake out an arc using the *Slope from arc method*:

1. Do one of the following:
 - ◆ From the map, select the arc to be staked out. Tap *Stakeout*, or tap and hold on the map and select *Stakeout* from the shortcut menu.
 - ◆ From the main menu, select *Survey / Stakeout / Arcs*. Enter the arc name.
2. In the *Stake* field, select *Slope from arc*.
3. Enter the antenna/target height and tap *Start*.
4. Use the graphical display to navigate to the point.

5. Mark the point and tap *Measure* to measure it.

At any point on the surface the graphical display shows the closest station, the Horizontal offset and the Vertical distance as a cut (4) or a fill (5).

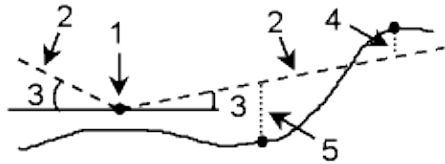

Intersect point of arc

Use this option as shown in the diagram below, to stake out the Intersection point (1) of an arc (2).

To stake out an arc using the *Intersect point of arc* method:

1. Do one of the following:
 - ◆ From the map, select the arc to be staked out. Tap *Stakeout*, or tap and hold on the map and select *Stakeout* from the shortcut menu.
 - ◆ From the main menu, select *Survey / Stakeout / Arcs*. Enter the arc name.
2. In the *Stake* field, select *Intersect point of arc*.
3. Enter the antenna/target height and tap *Start*.
4. Use the graphical display to navigate to the point.
5. Mark the point and tap *Measure* to measure it.

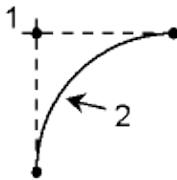

Center point of arc

Use this option, as shown in the diagram below, to stake out the Center point (1) of a defined arc (2).

To stake out an arc using the *Center point of arc* method:

1. Do one of the following:
 - ◆ From the map, select the arc to be staked out. Tap *Stakeout*, or tap and hold on the map and select *Stakeout* from the shortcut menu.
 - ◆ From the main menu, select *Survey / Stakeout / Arcs*. Enter the arc name.
2. In the *Stake* field, select *Center point of arc*.

Use the *Slope left* field and the *Slope right* field to define the type of grade in one of the following ways:

- ◆ horizontal and vertical distance
 - ◆ grade and slope distance
 - ◆ grade and horizontal distance
3. Enter the antenna/target height and tap *Start*.
 4. Use the graphical display to navigate to the point.
 5. Mark the point and tap *Measure* to measure it.

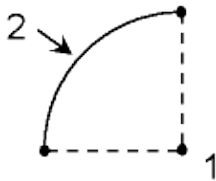

Tip - When selecting a line or arc to stakeout, tap near the end of the line or arc that you want to designate as the start of the line or arc. Arrows are then drawn on the line or arc to indicate the direction. If the direction of the line or arc is incorrect, tap the line or arc to deselect it and then tap it at the correct end to reselect the line or arc in the direction required.

Note - The offset directions are not swapped when the line direction is reversed.

Stakeout - Alignments

The Trimble Survey Controller software supports offsetting and stakeout of alignments, which are sometimes known as polylines.

Alignments always have a horizontal component; the vertical component is optional. If an alignment is created using entities that have elevations, the alignment will have a vertical component.

You can select or create and stake alignments using one of the following methods:

- [Key in point name ranges.](#)
- [Select one or more polylines in graphical view from a DXF/SHP file.](#)
- [Select a series of points in the map.](#)
 - The points can be from the current job, a linked job, or a linked csv file.
- Select a combination of points, lines, arcs, polylines, or alignments in the map.

You can edit alignments using *Key in / Roads*. The horizontal and vertical components are edited individually. If you edit the horizontal alignment, you must check if the vertical alignment also needs editing.

To create and stake an alignment by keying in a point name range:

1. From the main menu, select *Survey / Stakeout / Alignments*.

You can stake an existing alignment or key in a new alignment. If the *Point range* field is not visible, tap *New* to enter a new alignment.

2. Enter the point names that define the alignment.

The following name range techniques are supported:

Enter	Result
1,3,5	Creates a line between points 1 to 3 to 5
1-10	Creates lines between all points from 1 through 10
1,3,5-10	Creates a line between points 1 to 3, to 5, and 5 through 10
1(2)3	Creates an arc between points 1 and 3, through point 2
1(2,L)3	2 (Radius point), L (left) or R (right) Creates a Left hand arc between points 1 and 3, with point 2 as the radius point
1(100,L,S)3	1 to 3, radius=100, L (left) or R (right), L (large) or S (small) Creates a Left hand Small arc between points 1 and 3 with a radius of 100

3. To store the alignment, enable the *Store alignment* check box, enter an *Alignment name*, enter a *Code*, if required, and then tap *Next*.

This takes you to stakeout.

Alignments are stored as RXL files. If you save the alignment, you can easily stake it again, view it in the map, and share it with other jobs and with other controllers.

Tip - To offset the alignment, tap *Offset*. If the *Store alignment* check box is enabled, tap *Next* to store the alignment and go to stakeout. To store the alignment without going to stakeout, tap *Store*.

4. Select a *Station* to stake and then specify the *Station interval*.

You can select a station using one of the following methods:

- ◆ Select from the list in the *Stationing* field pop-up menu.
- ◆ Key in a value.
- ◆ Tap *Sta+* or *Sta-* to select the next/previous station.

5. To change target or antenna heights, tap the target icon in the status bar.
6. Select *Stakeout* and then use the graphical display to navigate to the point.
7. Mark the point and tap *Measure* to measure it.

To stake a polyline from a DXF/SHP file:

1. From the main menu, tap *Map*. Tap the up arrow to access more softkeys and then tap *Layers*.
2. Tap the file name once to make it visible; tap it again to make it selectable.

Tap  to expand the layers within a DXF file and to allow individual selection of layers to be visible and selectable.

3. Tap *Accept* to confirm the selection and return to the map.
4. Tap the polyline you want to stake.

Tap the end of the polyline that you want to be the start of the polyline.

5. To stake the polyline/alignment:

- ◆ Tap *Stakeout*, or tap and hold on the map screen, and then select *Stake out alignment*. This allows you to stake the polyline without storing the alignment.
- ◆ Tap and hold on the map screen and then select *Create/Offset alignment*. Complete the fields as required and then tap *Next*. You can then do one or more of the following:
 - ◇ stake the polyline
 - ◇ store the polyline as an alignment
 - ◇ offset and stake the alignment
 - ◇ store the offset alignment
 - ◇ store the offset alignment and store node points at vertices
 - ◇ stake the alignment or offset alignment

You can stake a polyline directly from a DXF/SHP file, but all polylines are converted to alignments for stakeout and when saved to the controller.

6. Select a *Station* to stake and then specify the *Station interval*.

You can select a station by one of the following methods:

- ◆ Select from the list in the *Stationing* field pop-up menu.
- ◆ Key in a value.
- ◆ Tap *Sta+* or *Sta-* to select the next/previous station.

7. To change target or antenna heights, tap the target icon in the status bar.
8. Select *Stakeout* and then use the graphical display to navigate to the point.
9. Mark the point and tap *Measure* to measure it.

To stake an alignment from the map:

1. From the main menu, tap *Map*. Tap the up arrow to display more softkeys and then tap *Layers*.
2. Tap the file name once to make it visible, tap it again to make it selectable.
3. Tap *Accept* to confirm the selection and return to the map.
4. Tap the alignment you want to stake.

The direction of an alignment and a Trimble road is defined when it is created; it cannot be changed.

5. To stake the alignment:

- ◆ Tap *Stakeout*, or tap and hold on the map screen, and then select *Stake out alignment*. This takes you directly to Stake out alignment.
- ◆ Tap and hold on the map screen and then select *Create/Offset alignment*. Complete the fields as required and then tap *Next*. You can then do one or more of the following:

- ◇ stake the polyline
 - ◇ store the polyline as an alignment
 - ◇ offset and stake the alignment
 - ◇ store the offset alignment
 - ◇ store the offset alignment and store node points at vertices
 - ◇ stake the alignment or offset alignment
6. Select a *Station* to stake and then specify the *Station interval*.

You can select a station by one of the following methods:

- ◆ Select from the list in the *Stationing* field pop-up menu.
 - ◆ Key in a value.
 - ◆ Tap *Sta+* or *Sta-* to select the next/previous station.
7. To change target or antenna heights, tap the target icon in the status bar.
 8. Select *Stakeout* and then use the graphical display to navigate to the point.
 9. Mark the point and tap *Measure* to measure it.

Offsetting alignments

You can create an offset alignment from a keyed-in alignment, an alignment saved as an RXL file, or a polyline from a DXF/SHP file.

When creating an offset alignment, you can stake the alignment without saving it, or you can give the alignment a name and then save the offset alignment as an RXL file. You can also create and save node points at the vertices of the horizontal alignment.

To offset and stake an alignment:

1. From the main menu, select *Survey / Stakeout / Alignments*.

You can select an existing alignment or key in a new alignment.

1. To select an existing alignment, tap the alignment name (if the *Select an alignment* screen is displayed). If the *Point range* field is displayed, tap *Select* to view the alignments already on the controller.
2. To key in a new alignment, enter the point names that define the alignment (if the *Key in alignment* screen is displayed). If the *Select an alignment* screen is displayed, tap *New* to enter the point range.

For more information, see the section [above](#).

2. To offset an alignment, tap *Offset*.
3. Enter the offset distance.
To offset to the left, enter a negative value.
4. To store the offset alignment, enable the *Store alignment* check box, enter an *Alignment name*, enter a *Code*, if required, and then tap *Next*. The alignment is stored as an RXL file.

- To store node points at the vertices of the offset alignment, enable the *Store points at nodes* check box, enter a *Start point name*, enter a *Code*, if required, and then tap *Next*.

Selecting *Next* stores the alignment, if the *Store alignment* check box is enabled, and takes you to stakeout. To store an alignment without going to stakeout, tap *Store*.

- Select a *Station* to stake, and specify the *Station interval*.

You can select a station by one of the following methods:

- ◆ Select from the list in the *Stationing* field pop-up menu.
- ◆ Key in a value.
- ◆ Tap *Sta+* or *Sta-* to select the next/previous station.

- To change target or antenna heights, tap the target icon in the status bar.
- Select *Stakeout* and then use the graphical display to navigate to the point.
- Mark the point and tap *Measure* to measure it.

An offset alignment will have a vertical component if the vertical geometry of the original alignment is coincident with the horizontal geometry and the vertical geometry consists only of points. The offset vertical geometry cannot include curves. If the vertical geometry of an alignment cannot be offset, only the horizontal component will exist in the offset alignment. You cannot offset an alignment that includes spirals.

Station abbreviations

The Trimble Survey Controller software uses the following abbreviations in the *Stationing* field pop-up menu.

Abbreviation	Meaning	Abbreviation	Meaning
CS	Curve to spiral	SS	Spiral to spiral
PC	Point of curvature (Tangent to curve)	ST	Spiral to tangent
PI	Point of intersection	TS	Tangent to spiral
PT	Point of tangent (Curve to tangent)	VCE	Vertical curve end
AS	Alignment start	VCS	Vertical curve start
AE	Alignment end	VPI	Vertical point of intersection
SC	Spiral to curve	XS	Regular sections
Hi	Vertical curve high point	Lo	Vertical curve low point

Stakeout - Digital Terrain Models (DTM)

A Digital Terrain Model is an electronic representation of a 3D surface. The Trimble Survey Controller software supports gridded and triangulated DTMs.

When you specify a DTM, you can view the cut and fill relative to the DTM. You must define a projection and datum transformation before you use a DTM in a GPS or conventional survey.

When a DTM is enabled in the Map, a color gradient shows the elevation changes. To disable the color gradient and show only an outline of the DTM, go to *Layers / Options* and then clear the *Display color gradient* check box.

To stake out a DTM:

1. Transfer a DTM file into the Trimble Survey Controller software then select *Survey / Stakeout / DTMs*.
2. Select the file to be used.
3. If necessary, specify a vertical offset to raise or lower the DTM.
4. To change target or antenna heights, tap the target icon in the status bar.

If the target or antenna height have not been defined, the elevation and cut/fill will be null (?).

5. Tap *Start*. The stakeout **graphical display** screen appears, displaying the coordinates of the current position and the vertical distance above (cut) or below (fill) the DTM.

Note - Unless you are using a conventional instrument that supports tracking (for example, a Trimble 5600), the values appear only after you have taken a distance measurement.

When staking out the DTM, if you are outside the extent of the DTM or in a "hole", the DTM elevation and cut/fill will be null (?).

To show the cut/fill to a DTM when staking out a point, line, arc, or road:

1. Tap *Options* in the *Stakeout* screen.
2. Select the *Display cut/fill to DTM* check box and specify the model.

Note - This does not apply to the *Slope from line* or *Slope from arc* stake methods.

To show the cut/fill to a DTM in the map:

1. Transfer a DTM file to the appropriate project folder on the controller.
2. From the main menu, tap *Map*. Tap the up arrow to display more softkeys and then tap *Layers*.
3. Tap the DTM file once to select the file and view it in the map; tap the DTM file name again to make it active. Tap *Accept* to return to the map.

When the DTM is active and the map has a position on the DTM, the DTM elevation, and the vertical distance above (cut) or below (fill) the DTM appear in the map screen.

4. If necessary, specify a vertical offset to raise or lower the DTM.
The vertical offset can be configured in *Layers / Options* when you select the DTM file. When defined, the vertical offset also appears in the Map of current job.
5. To change target or antenna heights, tap the target icon in the status bar.

If the target or antenna height have not been defined, the elevation and cut/fill will be null (?).

Stakeout - Roads

The Trimble Survey Controller software supports stakeout for three road formats:

- [Trimble](#) roads
- Roads derived from a [GENIO](#) file
- Roads derived from a [LandXML](#) file

Road files are not job-specific. All road files stored in a project folder are available to all jobs in that same project folder.

For functions such as editing, displaying in the map, and stake out, all road files must be in the same folder as the current job.

Trimble roads

Trimble roads can be:

- Keyed in using *Key in Roads*.
- Uploaded from Trimble RoadLink software (a module of the Trimble Geomatics Office software).
- Uploaded via Trimble Link from a number of third party design packages including Autodesk Land Desktop, Autodesk Civil 3D, Bentley Inroads, and Bentley Geopak.
- Imported as a DC file.

Keyed-in roads are stored as 'road name'.rxl files in the current project folder.

For information on how to key in a road, see [Roads](#), and [Templates](#).

When a job that contains a road is uploaded to the Trimble Survey Controller software, the road is removed from the job and a new file is created. This new file defines the road, it is renamed with the name of the road and the job, and has the filename extension ".rxl". The RXL file is saved to the same project folder as the job. If there is a road of the same name in this folder, it is overwritten by the uploaded road file.

When a DC file that contains a road is copied to the Trimble Survey Controller software and then converted to a job, a new file that defines the road is created and renamed with the name of the road and the job, and the filename extension RXL. If an RXL file of the same name exists the RXL file has "(1)" added to the name. If the DC file is converted a second time, the resulting RXL file has "(2)" added to the file name, and so on, each time that file is converted.

For more information on how to transfer files, see [Transferring Files between the Controller and the Office Computer](#).

For more information on staking Trimble roads, see [Staking Trimble roads](#).

GENIO files

GENIO files that define a road can be exported from a number of third party road design software packages,

including MX and [12D Model](#).

The file extension for the GENIO file must be *.CRD, *.INP, or *.MOS. Files with the extension MOS are exported from [12D Model](#).

For more information on staking roads from GENIO files, see [Staking roads from GENIO files](#).

LandXML files

LandXML files that define a road can be exported from a number of third-party road design software packages.

For more information on staking roads from LandXML files, see [Staking roads from LandXML files](#).

Road stakeout details that apply to all three road formats

The Trimble Survey Controller software treats all road distances, including *Stationing* and *Offset* values, as grid distances. The value in the *Distances* field (accessed by selecting *Files / Properties of current job - Cogo settings*) has no effect on the road definition or the way road distances are displayed.

If a ground coordinate system is defined in either the Trimble Geomatics Office or Trimble Survey Controller software, then the grid coordinates are, in effect, also ground coordinates.

Go Forward/Go Backward directions

As shown in the diagram below, the values in the *Go Forward/Go Backward* (1) and *Go Right/Go Left* (2) fields in the graphical display are relative to the cross-section of the point that you are staking out. They are **not** relative to the current direction of travel, or to the current stationing. The direction of increasing stationing is shown by (3).

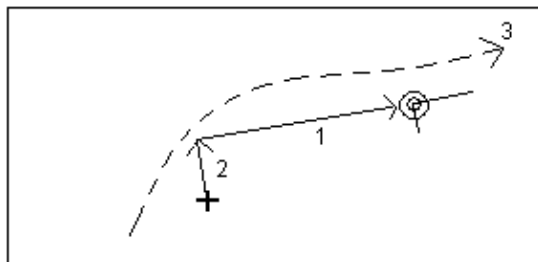

Target in the graphical display

As shown in the diagram below, the bull's-eye symbol in the graphical display also shows the road-space coordinate frame. The longer line (1) on the symbol shows the direction of increasing stationing and the shorter line (2) shows the direction of increasing offset (the right side of the road).

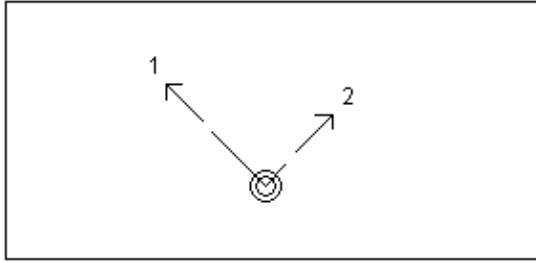

Exporting GENIO files from 12D Model

To export a road as a GENIO file from 12D Model:

1. Start 12D Model and select a project.
2. Select *File I/O / Data output - GENIO*.
3. From the *Write GENIO File for* dialog, select the alignment string as the data to write.
4. Enter a file name.
5. Set the *Alignment dimension* field to 6D.
6. Select the *77 Format* check box.
7. Write the file but do not select *Finish*.
8. Select the remaining strings that define the road as the data to write.
9. Retain the file name used to write the alignment string.
10. Set the *Alignment dimension* field to 3D.
11. Write the file and then select *Yes* to append to the end of the existing file.
12. Select *Finish*.

Tip - Use the filter option to aid string selection.

Staking Trimble Roads

The Trimble Survey Controller software enables you to stake out a Trimble road by the following methods:

[Station and offset](#)

[Position on road](#)

[Nearest offset](#)

[Side slope from alignment](#)

Only the road files in the current [project folder](#) are available for stake out.

Note - You must specify a coordinate system before you can stake out roads with the Trimble Survey Controller software.

Warning - Do not stake out points and then change the coordinate system or perform a calibration. If you do, these points will be inconsistent with the new coordinate system and any points computed or staked out after the change.

Trimble roads - Station and offset

To stake out by station and offset in a Trimble road when you perform an RTK survey:

1. From the main menu, select *Survey / Stakeout / Roads*.
2. Highlight the road name and tap *Stakeout*.

Tip - If you are warned that the road is incomplete or invalid return to *Key in / Roads* and select the road. Open each component defining the road and tap *Accept*. This will validate the component and report any errors in the definition. Use the editing functionality to resolve the error.

3. In the *Stake* field, select *Station and offset*.
4. Enter a value in the *Antenna/Target height* field and make sure that the *Measured to* field is set correctly.
5. To select the point to be staked out, enter values in the *Station* and *Offset* fields.

The *Code* field displays the code of the offset to be staked out. The Trimble Survey Controller software uses the code from the template definition for the selected offset. When the offset is 0.000 m, the code defaults to CL.

6. To edit the design elevation, tap the arrow. To reload an edited elevation, select *Reload original elevation* from the pop-up menu in the *Design elevation* field.

Note - If the position that you select for stakeout has no elevation, the *Design elevation* field becomes available. Enter an elevation into this field.

7. If required, enter values in the *Construction offsets* fields.
8. Select *Start* and use the graphical display to navigate to the point.
9. Tap *XS* to view the *cross section* of the selected station.

To define a cross slope, see [Cross slope](#).

If the road consists of a horizontal and vertical alignment only, the *V. dist* value reports the vertical distance to the centerline.

12. If you are staking to a *catch point* with construction offsets, navigate to the catch point and then tap *Apply* to add the construction offsets. You are prompted to apply the offsets from your current position. If you are not on the catch position, select *No*, navigate to the catch position and then tap *Apply* again.

If you want to store the catch position and the construction offset, see [Construction offsets](#).

Select *XS* for further graphical navigation. The construction offsets are indicated by green lines with the smaller single circle indicating the calculated catch position and the double circle indicating the selected position adjusted for the specified construction offset(s). The construction offsets are only displayed after you have applied them.

13. Mark the point with a stake.
14. When the point has been marked, you can measure it as an As-staked point by tapping *Enter* to go into the *Stakeout / Point* screen.

If a road has a horizontal and vertical alignment, but has no templates, all offset points display a null (?) value in the *V. dist* field during stakeout. If a road definition is defined only as a horizontal alignment, you can only stake it out in two dimensions. The horizontal and vertical alignments of a road do not necessarily start and end at the same stationing. When they start and end at different stationing, you can only stake out points in three dimensions if their stations lie within the horizontal alignment.

See also:

[Catch point](#)

[Side slope offset selection](#)

[Catch point staked deltas](#)

Selecting a station

You can select a station by one of the following methods:

- Select from the list in the *Stationing* field pop-up menu.
- Key in a value.
- Tap *Sta+* or *Sta-* to select the next/previous station.

The stations in the list are controlled by the [Station interval](#) and by the [Available stations](#) option in the [Stakeout options](#) dialog. The following table lists the abbreviations that the Trimble Survey Controller software uses.

Abbreviation	Meaning	Abbreviation	Meaning
CS	Curve to spiral	SS	Spiral to spiral
PC	Point of curvature (Tangent to curve)	ST	Spiral to tangent
PI	Point of intersection	TS	Tangent to spiral
PT	Point of tangent (Curve to tangent)	VCE	Vertical curve end
RE	Road end	VCS	Vertical curve start
RS	Road start	VPI	Vertical point of intersection
SC	Spiral to curve	XS	Regular sections
Hi	Vertical curve high point	Lo	Vertical curve low point

SES	Superelevation start	SEM	Superelevation maximum
SEE	Superelevation end	WS	Widening start
WM	Widening maximum	WE	Widening end
T	Template assignment	STEQ	Station equation

Selecting an offset

You can select an offset by one of the following methods:

- In the *Offset* field, select *List* from the pop-up menu and then select from the list.
- Key in a value.

Enter a negative value for an offset to the left of the centerline; enter a positive value for an offset to the right. If you enter a value greater than the maximum offset in the template, a message appears to warn you that the offset is outside the range. The software asks if you want to use the left side slope, or right side slope, depending on the value entered. If you tap *No*, another message appears to warn you that point positions will be in two dimensions, and asks whether you want to continue. This option is useful if you need to stake out the 2D position of a feature not defined in the template (for example, the position of a lamppost).

- To select the next left/next right template element or the rightmost/leftmost element, tap *Offs>>*.

Tips

- ◆ If you select an offset from the list, for all subsequent station values, the offset value is updated to reflect any widening or interpolation.
- ◆ If you enter an offset value, that value is maintained for all subsequent station values, even when the entered value corresponds to a value in the list.

Consider the following diagram. If you **select** offset 5 m at station 0 m, the offset value is updated to follow the solid line for subsequent stations. The value changes from offset 5 m to offset 8 m. If you **enter** offset 5 m for the offset, the offset follows the dashed line. The offset of 5 m is maintained for subsequent stations.

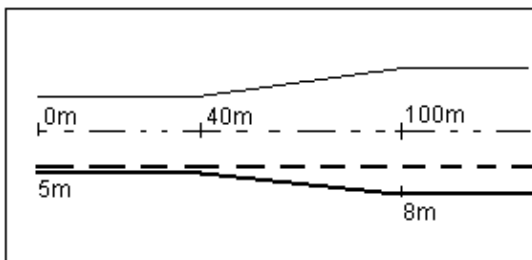

Stakeout - Available Stations

Note - This function is not available for roads derived from GENIO or LandXML files.

When using Trimble roads, to configure the stations available for the *Stations* field, select the appropriate check boxes in *Available Stations*, accessed from the *Options* softkey in *Stake out road*.

Select one of the following check boxes to make the appropriate stations available:

1. *Regular Sections* (stations defined by the station interval)
2. *Horiz. Curve* (key stations defined by the horizontal alignment)
3. *Vert. Curve* (key stations defined by the vertical alignment)
4. *Template* (stations where templates have been assigned)
5. *Super/Widen* (stations where superelevation and widening has been assigned)

Selecting a New Offset for a Side Slope

Note - This function is not available for roads derived from GENIO or LandXML files.

For Trimble roads, if the designed road does not fit the field conditions well, you can select a new offset for the side slope. The following diagram shows a typical example of where you might use this option.

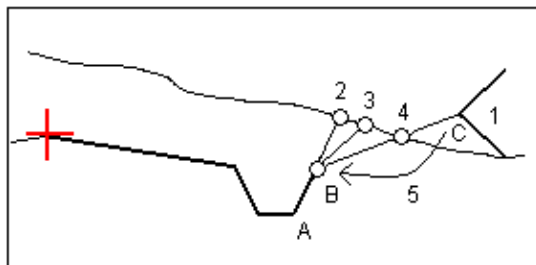

Key to the above diagram.

- 1 - Design side slope
- 2 - New catch position defined by the slope of the previous element (A - B)
- 3 - New catch position defined by the design cut slope value
- 4 - New catch point position defined by the slope of the next element (B - C)
- 5 - Side slope offset is moved from offset C to offset B to avoid an unwanted fill zone

To select a new side slope offset:

1. From the main menu, select *Survey / Stakeout Roads*.
2. Highlight the road name and tap *Stakeout*.
3. From the pop-up menu in the *Offset* field, select the *Select new offset for side slope* option. Select a new offset. You can not select offset 0.000 or the Side Slope.

Note - Select the offset immediately preceding a side slope (the hinge position of the original side slope) if you only want to edit the side slope values.

4. The *Side slope definition* group appears, showing the as-designed values for the selected station. You can edit these values if required.

5. If required, enter values in the *Construction offsets* fields.
6. Select *Start* and use the graphical display to navigate to the point.

In some situations, it may be preferable to adjust the cut or fill slope value to that of the next or previous template element. See 5 in the diagram above for a typical example.

To edit the slope value to that of the next or previous template element:

1. Access the *Side slope* definition group
2. In the pop-up menu in either the *Cut slope* field or the *Fill slope* field, select *Next element slope* or *Previous element slope*.
The *Slope* field updates with the appropriate slope value.

Notes

- The next or previous element slope options are available only if the next or previous elements exist.
- In the *Cut slope* field, the options are available only if the next or previous slope values are positive, that is, if they define a cut slope.
- In the *Fill slope* field, the options are available only if the next or previous slope values are negative, that is, if they define a fill slope.

Position relative to a Trimble road

To determine your current position relative to a Trimble road:

1. From the main menu, select *Survey / Stakeout / Roads*.
2. Highlight the road name and tap *Stakeout*.

Tip - If you are warned that the road is incomplete or invalid return to *Key in / Roads* and select the road. Open each component defining the road and tap *Accept*. This will validate the component and report any errors in the definition. Use the editing functionality to resolve the error.

3. In the *Stake* field, select *Position on road*.
4. Enter a value in the *Antenna/Target height* field and make sure that the *Measured to* field is set correctly.
5. If there is a value in the *V.Offset* field, the Trimble Survey Controller software reports your position relative to the design, as adjusted by the specified vertical offset:
 - ◆ A negative value offsets the design vertically down, a positive value up.

Note - The *V.Offset* value specified here is not applied to a DTM surface.

6. Tap *Start*. The graphical stakeout screen appears.

The graphical display in the plan view shows your current position relative to the road. The display includes the offset from the centerline and your current elevation. The right side of the screen reports

your current position relative to the road in terms of station, offset, and vertical distance to the road surface.

7. Tap *XS* to view the [cross section](#) of the selected station.

You can measure your current position as an *As-staked* point by tapping *Enter* to go into the *Stake out point* screen.

Note - If you are using a conventional instrument, the road values only appear after you take a distance measurement.

If your current position is more than 30 meters from the road centerline, the graphical display navigates you to a position on the road centerline. This is calculated by projecting your current position at right angles to the centerline.

If the road consists of only a horizontal and vertical alignment the *V.dist* value will report the vertical distance to the centerline.

Nearest offset

To stake relative to an offset for a Trimble road:

1. From the main menu, select *Survey / Stakeout / Roads*.
2. Highlight the road name and tap *Stakeout*.

Tip - If you are warned that the road is incomplete or invalid return to [Key in / Roads](#) and select the road. Open each component defining the road and tap *Accept*. This will validate the component and report any errors in the definition. Use the editing functionality to resolve the error.

3. In the *Stake* field, select *Nearest offset*.
4. Enter a value in the *Antenna/Target height* field and make sure that the *Measured to* field is set correctly.
5. To choose the offset to stake out, enter a value in the [Offset](#) field.

The *Code* field displays the code of the offset to be staked out. Trimble Survey Controller uses the code from the template definition for the selected offset. When the offset is 0.000 m, the code defaults to CL.

6. If required, enter values in the [Construction offsets](#) fields.

Tip - For Trimble roads where an offset other than *Nearest* has been selected you can define a horizontal construction offset by your current position. See: [Construction offsets](#) for details.

7. To navigate to the selected offset, select *Start* and then use the graphical display.
8. Tap *XS* to view the [cross section](#) of the selected station.

To define a cross slope, see [Cross slope](#).

9. If you are staking to a [catch point](#) with construction offsets, navigate to the catch point first and then tap *Apply* to add the construction offsets. You are prompted to apply the offsets from your current position. If you are not on the catch position, select *No*, navigate to the catch position and then tap *Apply* again.

If you want to store the catch position and the construction offset, see [Construction offsets](#) .

10. Mark the point with a stake.
11. When the point has been marked, you can measure it as an *As-staked* point by tapping *Enter* to go into the *Stakeout / Point* screen.

Note - If you are using a conventional instrument, the road values only appear after you take a distance measurement.

The graphical display in the plan view shows your current position relative to the selected offset and also reports the offset from your current position to the centerline and your current elevation. The right side of the screen reports your current position in terms of station, offset to the selected offset, and vertical distance from your current position to the selected offset.

Selecting an offset

You can select an offset by one of the following methods:

- In the *Offset* field, select *List* from the pop-up menu and then select an option from the list. If you select *Nearest* from the list, the software navigates you to the offset nearest to your current position.
- Key in a value.

Enter a negative value for an offset to the left of the centerline.

Enter a positive value for an offset to the right of the centerline.

Tips

- ◆ If you select an offset from the list, for all subsequent station values, the offset value is updated to reflect any widening or interpolation.
- ◆ If you enter an offset value, that value is maintained for all subsequent station values, even when the entered value corresponds to a value in the list.

Consider the following diagram. If you **select** offset 5 m at station 0 m, the offset value is updated to follow the solid line for subsequent stations. The value changes from offset 5 m to offset 8 m.

If you **enter** offset 5 m for the offset, the offset follows the dashed line. The offset of 5 m is maintained for subsequent stations.

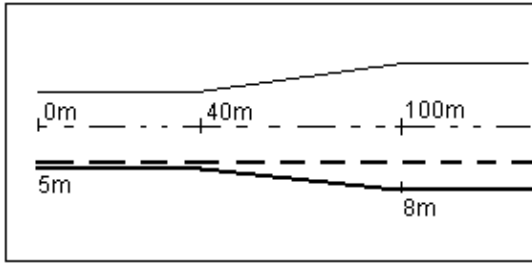

Staking out a Side Slope Relative to an Alignment

To define and stake a side slope for a Trimble road:

1. From the main menu, select *Survey / Stakeout / Roads*.
2. Highlight the road name and tap *Stakeout*.

Tip - If you are warned that the road is incomplete or invalid return to [Key in / Roads](#) and select the road. Open each component defining the road and tap *Accept*. This will validate the component and report any errors in the definition. Use the editing functionality to resolve the error.

3. In the *Stake* field, select *Side slope from alignment*.
4. Enter a value in the *Antenna/Target height* field and make sure that the *Measured to* field is set correctly.
5. Entering a value in the *Stationing* field. For more information, see the section [Selecting a station in Stakeout Roads](#).
6. Select a *Hinge derivation* method and complete the appropriate fields. The following diagram explains the three hinge derivation methods:

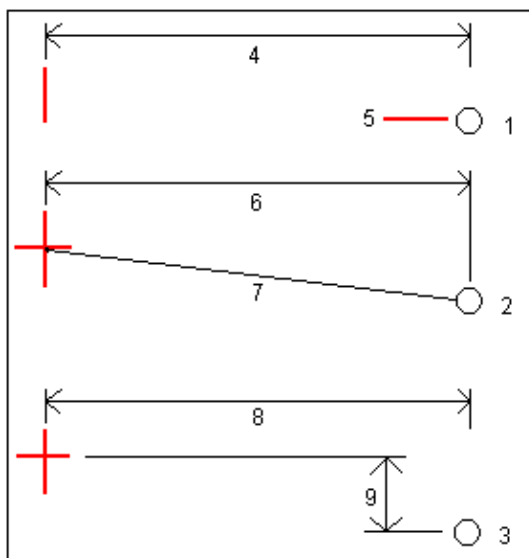

Key to the above diagram:

- 1 - Offset and elevation. Enter an offset (4) from the horizontal alignment, and the elevation (5) of the hinge position.
- 2 - Offset and slope. Enter an offset (6) from the horizontal alignment, and the slope value (7) from the intersection of the horizontal and vertical alignments to the hinge position.
- 3 - Offset and vertical distance. Enter an offset (8) from the horizontal alignment, and the vertical difference (9) from the intersection of the horizontal and vertical alignments to the hinge position.

Note - If the road definition consists of only a horizontal alignment, the only hinge derivation method available is Offset and elevation.

8. Complete the appropriate fields to define the [Side slope](#).
9. If required, enter values in the [Construction offsets](#) fields.
10. Select *Start* and use the graphical display to navigate to the point.

The graphical display in the plan view shows your current position along with the target. Also displayed is a dashed line that connects the side slope catch position - the point where the side slope intersects with the ground-to the side slope hinge position. The calculated slope value (in blue) and the design slope value is displayed at the top of the screen.

11. Tap *XS* to view the [cross section](#) of the selected station.
12. If you are staking to a [catch point](#) with construction offsets, navigate to the catch point and then tap *Apply* to add the construction offsets. You are prompted to apply the offsets from your current position. If you are not on the catch position, select *No*, navigate to the catch position and then tap *Apply* again.

If you want to store the catch position and the construction offset, see [Construction offsets](#).

Select *XS* for further graphical navigation. The construction offsets are indicated by green lines with the smaller single circle indicating the calculated catch position and the double circle indicating the selected position adjusted for the specified construction offset(s). The construction offsets are only displayed after you have applied them.

13. Mark the point with a stake.
14. When the point has been marked, you can measure it as an *As-staked* point by tapping *Enter* to go into the *Stakeout / Point* screen.

Note - To also stake the appropriate hinge position, tap *Select>>* and select either the *Hinge point (Cut)* or *Hinge point (Fill)* option.

Staking Roads from GENIO Files

The Trimble Survey Controller software enables you to stake out a road from a GENIO file by the following methods:

[Position on road](#)

[Along a string](#)

[Station on string](#)

Only the road files in the current [project folder](#) are available for stake out.

The following tips help you to understand how to graphically activate the three methods of staking out a GENIO road:

- By default, the Trimble Survey Controller software is in the *Position on road* method until you select a string to stake or a position to stake.
- To select a string to stake, tap the linework that represents a string in the plan view.
- To select a string and station to stake, tap the circle that represents the position in the plan view. Once you activate the string and station method, the [cross section](#) view is available. You can also graphically select positions from that view.
- To return to the *Position on road* method, tap in a clear space to clear the current selection, or reselect the current selection.
- For all three methods, the current method is indicated in the title banner.
- To graphically activate a method, you must be in the plan view selection screen that appears immediately after you select the GENIO file and Group, and tap *Start*.

Tip - If the master string has been excluded (the master string appears greyed out in the plan view and does not appear in the cross section view) and you want to stake it out, return to the *Group* option, tap and hold in the graphics view and then select [Exclude master at stakeout](#) from the pop-up menu.

Note - You must specify a coordinate system before you can stake out roads with the Trimble Survey Controller software.

Warning - Do not stake out points and then change the coordinate system or perform a calibration. If you do, these points will be inconsistent with the new coordinate system and any points computed or staked out after the change.

Tip - To improve performance when loading large GENIO files increase the available memory. The following is an indication of loading times for GENIO files:

For a 1 MB GENIO file the load time is approximately 20 seconds

For a 3 MB GENIO file the load time is approximately 1 minute

Group strings

To define a new group of strings that describe a road to be staked:

1. From the *Group strings* option tap *New* and then enter a Group name.
2. From the graphics window, tap strings to select them. Alternatively, drag a box outline to select multiple strings. Selected master strings are shown as solid red circles. Selected sub strings are shown

- as solid blue circles. Tap a selected string to deselect it.
3. To clear your current selection or to undo your last selection, tap and hold in the graphics window and then select the appropriate option from the pop-up menu.
 4. To select strings from a list of string names, tap and hold in the graphics window and then select *List selection* from the pop-up menu. Tap the string names you want to select. Selected strings appear in the list with a check mark next to them. To clear your current selection, tap *Clear*.

Tip - To activate the pop-up menu if the touch screen has been disabled, press the space bar.

Notes

- A group can include only one master string (6D). If the GENIO file does not include a 6D string but does include a 12D string, then the Trimble Survey Controller software will generate a 6D string with the same geometry as the 12D string and positions every 5 meters / feet.
- Because the station values for 3D and 5D strings are defined relative to the selected 6D string, select strings for the group that obviously define a road.
- Where available, Trimble recommends that you include the 12D string that is coincident with the selected master string in the group. 12D strings include the geometry for the vertical alignment that enables the Trimble Survey Controller software to correctly interpolate elevations between positions along the master string.
- Unselected master and geometry strings appear as open red circles. Unselected sub strings (3D and 5D) appear as open dark gray circles.
- Tap and hold on a string to browse the string name.
- To define a new 3D string, tap and hold in the graphics view and select *New string* from the pop-up menu. This option is not available until you have selected a master (6D) string.
- To exclude the master string, tap and hold in the graphics view and select *Exclude master at stakeout* from the pop-up menu.

Exclude Master at stakeout

If the Master string (6D) has a vertical geometry that is unrelated to the road design, you can exclude this string when staking out.

To do this:

- From the *Group strings* option, tap and hold in the graphics window and from the pop up menu select *Exclude master at stakeout*.

The master string will still be part of the group and will be used to calculate the station values at stakeout.

At stakeout, the master string will appear greyed out in the plan graphical selection screens and does not appear in the cross section view. The master string will also be unavailable from the string selection list.

Tip - To ensure that the master string is available at stakeout, clear *Exclude master at stakeout*.

New Strings

Use this function to **define** a new string, **edit** a string you have defined, or **delete** a string.

Defining a new string

1. From the *Group strings* option, create a new group or edit an existing group.
2. Tap and hold on the screen and then select *New string* from the pop-up menu.
3. Enter a string name.
4. Select the string from which the new string will be derived.
5. Select a string derivation method.
6. If the derivation method is *Offset and slope* or *Offset and Vertical diff*, enter values that define the new string.

If the derivation method is *Offset and calculated slope*, the slope value to the new string (4) is the calculated slope between the *Derive from* string (1) and the *Calculated from* string (3). The offset (2) is the distance from the derived string. See the following diagram:

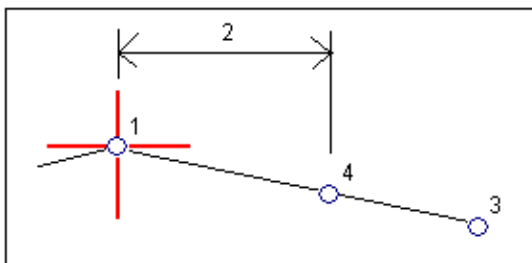

7. Tap *Accept*.

Notes

- When you define a new group, you must select a master (6D) string before the *New string* menu option is available.
- New strings are created as 3D strings.
- You cannot define a new string relative to a 5D string.

Editing a new string

1. From the *Group strings* field, select *Edit* and then select the group containing the string to edit.
2. Tap and hold in the graphics screen and select *Edit string* from the pop-up menu.
3. Select the string to edit. You can only edit strings that have been defined using the **New** string functionality and that belong to the current group.
4. Edit the details as required.
5. Tap *Accept*.

Deleting a string

1. From the *Group strings* field select *Edit* and then select the group containing the string to delete.

2. Tap and hold in the graphics screen and then select *Delete string* from the pop-up menu.
3. Select the string to delete. You can only delete strings that have been defined using the [New](#) string function.
4. Tap *OK*.

Tip - To activate the pop-up menu if the touch screen has been disabled, press the space bar.

Position relative to GENIO road

To determine your current position relative to a GENIO road:

1. From the main menu, select *Survey / Survey style / Stakeout / Roads*.
2. Highlight the road name and tap *Stakeout*.
4. Use the [Group strings](#) option to create and manage a group of strings that define a road. To view a list of existing groups, tap the arrow and select *List*. To define a new group, select *New*. You can also rename, edit or delete an existing group.
5. Enter a value in the *Antenna/Target height* field.
6. Tap *Start*. The graphical point selection screen appears displaying the road. Because you want to know your position relative to the road, do not select a position to stake.

Tip - When you select *Start*, the software calculates the station values for all 3D strings relative to the 6D string for the group. The time taken to calculate the station values varies with the number of strings in the group and the length of the road. To improve performance when staking large GENIO files, Trimble recommends that you limit the number of strings in a group.

7. To apply construction offsets, tap and hold in the graphics window and then select *Define construction offsets* from the menu. If a vertical offset is specified, the software reports your position relative to the design, as adjusted by the specified vertical offset.
 - ◆ A negative value offsets the design vertically down.
 - ◆ A positive value offsets the design vertically up.

Note - The *Vertical Offset* value specified here is not applied to a DTM surface.

Tip - To activate the pop-up menu if the touch screen has been disabled, press the space bar.

8. Tap *Stakeout*.

The graphical display in the plan view shows your current position relative to the road. The base of the screen reports your current position relative to the road in terms of station, offset to the centerline, and vertical distance to the road surface.

To understand how your position is calculated between strings, see [String interpolation](#).

Tip - To view the [cross section](#) of your current position, tap the icon at the bottom right of the graphics window. Alternatively, press the [Tab] key on the controller to switch between the plan view and the cross section view.

Note - If you are using a conventional instrument, the road values only appear after you take a distance measurement.

If your current position is more than 30 meters from the road centerline, the graphical display navigates you to a position on the road centerline. This is calculated by projecting your current position at right angles to the centerline.

If the road consists of only a horizontal and vertical alignment the *V.dist* value will report the vertical distance to the centerline.

9. You can measure your current position as an *As-staked point* by tapping *Enter* to go into the *Stake out point* screen.

Stakeout along a string

To stake out a GENIO file road along a string:

1. From the main menu, select *Survey / Survey style / Stakeout / Roads*.
2. Highlight the road name and tap *Stakeout*.
4. Use the *Group strings* option to create and manage a group of strings that define a road. To view a list of existing groups, tap the arrow and select *List*. To define a new group, select *New*. You can also rename, edit or delete an existing group.
5. Enter a value in the *Antenna/Target height* field.
6. Tap *Start*. The graphical selection screen appears displaying the road.

Tip - When selecting *Start* the Trimble Survey Controller software calculates the station values for all 3D strings relative to the 6D string for the group. The time taken to calculate the station values varies with the number of strings in the group and the length of the road. To improve performance when staking large GENIO files, Trimble recommends that you limit the number of strings in a group.

7. To select a string from the plan view, do one of the following:

- ◆ Tap the linework that defines the string.
- ◆ Tap and hold in the graphics window and then select a string from the list.
- ◆ Tap and hold in the graphics window and then key in a string name.

Tip - To activate the pop-up menu if the touch screen has been disabled, press the space bar.

Once you select a string, tap the icon in the bottom right corner of the graphics window to view the cross section. From the cross section view, you can select a different string to stake using any of the methods described above. To return to the plan view, tap the icon again. Alternatively, press the [Tab] key on the controller to switch between the plan view and the cross section view.

To define a cross slope, see [Cross slope](#).

To define a subgrade, see [Subgrade](#).

Note - If the road includes multiple side slopes that define benched side slopes, only the 5D / Interface string that is furthest from the centerline will be converted to a side slope.

9. To apply construction offsets, tap and hold in the graphics window and then select *Define construction offsets*.
10. Tap *Stakeout* and then use either the plan or *cross section* graphical display to navigate along the string.

The Trimble Survey Controller software interpolates elevation values along the string. For more information, see *String interpolation*.

11. Mark the point with a stake.

Note - For 5D / Interface strings, the target may not coincide with the design position because the target is calculated relative to your current position.

12. When the point has been marked, you can measure it as an *As-staked point* by tapping *Enter* to go into the *Stakeout / Point* screen.

Note - If you are staking a *catch point* (5D / Interface string) with construction offsets, navigate to the catch point and then tap *Apply* to add the construction offsets. You are prompted to apply the offsets from your current position. If you are not on the catch position, select *No*, navigate to the catch position and then tap *Apply* again.

If you want to store the catch position and the construction offset, see *Construction offsets*.

Notes

- If the string selected to stake is a 5D string Trimble Survey Controller converts this string to a side slope. The calculated slope value is defined by the slope between the 5D string and the adjacent 3D string.

Tip - To configure the software to treat a 5D string as a 3D string, select *Options* and then clear the *Auto side slope* option.

- For GENIO files defined from 12D Model, Trimble Survey Controller treats all strings with a name that includes the letters INT as a 5D string and converts the string to a side slope. The calculated slope value is defined by the slope between the interface string and the adjacent 3D string.

Stakeout station on string

To stake out a GENIO file road by the string and station method:

1. From the main menu, select *Survey / Survey style / Stakeout / Roads*.
2. Highlight the road name and tap *Stakeout*.
4. Use the *Group strings* option to create and manage a group of strings that define a road. To view a list

of existing groups, tap the arrow and select *List*. To define a new group, select *New*. You can also rename, edit or delete an existing group.

5. Enter a value in the *Antenna/Target height* field.

6. Tap *Start*. The graphical selection screen appears displaying the road.

Tip - When selecting *Start* the Trimble Survey Controller software calculates the station values for all 3D strings relative to the 6D string for the group. The time taken to calculate the station values varies with the number of strings in the group and the length of the road. To improve performance when staking large GENIO files, Trimble recommends that you limit the number of strings in a group.

7. To select a position from the plan view, do one of the following:

- ◆ Tap the position.
- ◆ Tap any position and then use the arrow keys on the Trimble controller to navigate to the position.
- ◆ Tap and hold in the graphics window and then select a string and station value from the list.
- ◆ Tap and hold in the graphics window and then key in a string name and station value.

Tip - To activate the pop-up menu if the touch screen has been disabled, press the space bar.

The Trimble Survey Controller software also supports staking nominal offset and station values. To do this, tap and hold in the graphics window, select the string to stake and then key in a numeric value that represents the offset. Similarly, from the *Station to stake* field, key in a nominal station value. For more information, see [String interpolation](#).

Once you select a position, tap the icon in the bottom right corner of the graphics window to view the cross section. From the cross section view, you can select a new position to stake using any of the methods described above. To return to the plan view, tap the icon again. Alternatively, press the [Tab] key on the controller to switch between the plan view and the cross section view.

In the plan and cross section views, the bull's-eye icon (double circle) indicates the selected position. In the plan view, a selected string is shown with solid circles. To browse the string name, tap and hold on a string.

To define a cross slope, see [Cross slope](#).

To define a subgrade, see [Subgrade](#).

To stake relative to a secondary road, see [Secondary road](#).

Note - If the road includes multiple side slopes that define benched side slopes, only the 5D / Interface string that is furthest from the centerline will be converted to a side slope.

8. To edit the design elevation, tap and hold in the graphical window and then select *Edit elevation*. To reload an edited elevation, select *Reload original elevation* from the pop-up menu in the *Design elevation* field.

9. To apply construction offsets, tap and hold in the graphics window and then select [Define construction offsets](#).

10. Tap *Stakeout* to begin navigating using either the plan or [cross section](#) graphical display to navigate to the point.

Tips

- ◆ To select the delta display, tap the arrow to the left of the navigation deltas.
- ◆ To edit the side slope value of a selected 5D / Interface string, tap and hold on the screen and then select *Edit side slope* from the menu. If there are no values at the top of the navigation screen for design or calculated side slope, this means that ground conditions require the opposing slope value to be staked. You can edit the null (?) value.
- ◆ To select a new hinge string for a selected 5D / Interface string, tap and hold on the screen and then select *Edit side slope* from the menu. From the *Hinge string* field tap the arrow and then select a new string from the cross section graphics. The current hinge string is shown as a solid blue circle.

11. Mark the point with a stake.

Note - For 5D / Interface strings, the target may not coincide with the design position because the target is calculated relative to your current position.

12. When the point has been marked, you can measure it as an *As-staked point* by tapping *Enter* to go into the *Stakeout / Point* screen.

Note - If you are staking a [catch point](#) (5D / Interface string) with construction offsets, navigate to the catch point and then tap *Apply* to add the construction offsets. You are prompted to apply the offsets from your current position. If you are not on the catch position, select *No*, navigate to the catch position and then tap *Apply* again.

If you want to store the catch position and the construction offset, see [Construction offsets](#).

Notes

- If the string selected to stake is a 5D string Trimble Survey Controller converts this string to a side slope. The calculated slope value is defined by the slope between the 5D string and the adjacent 3D string.

Tip - To configure the software to treat a 5D string as a 3D string, tap [Options](#) and then clear the *Auto side slope* option.

- For GENIO files defined from 12D Model, Trimble Survey Controller treats all strings with a name that includes the letters INT as a 5D string and converts the string to a side slope. The calculated slope value is defined by the slope between the interface string and the adjacent 3D string.

Staking relative to a secondary road

This function enables stakeout details from a secondary road to be referenced to a position being staked on a

primary (current) road. See the following diagram:

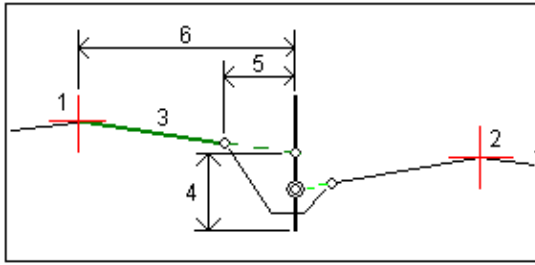

To do this:

1. From the main menu, select *Survey / Survey style / Stakeout / Roads*.
2. Highlight the road name and tap *Stakeout*.
3. To define the primary and secondary groups, select the *Group strings* option.
4. Select the primary road (group) to stake.
5. Enter a value in the *Antenna/Target height* field.
6. Tap *Start*. The primary road is displayed. Select the position to stake.
7. From either the plan or cross section view, tap and hold in the graphics window and then select *Select secondary group* from the menu. From the list of groups, select the group representing the secondary road. The secondary road appears as unavailable in the plan view. From the plan view, you cannot select positions to stake on a secondary road.
8. From either the plan or cross section view, tap and hold in the graphics window and then select *View secondary cross section* from the menu. From the displayed cross section for the secondary road (1), tap the line (3) preceding the position you want to stake. A green line is projected to the stake position on the primary road (2).

Note - Stake details for the secondary road reported in the *As staked deltas* include:

- ◆ V.dist to road (4)
 - ◆ Horizontal construction offset (calc'd) (5)
 - ◆ Distance to centerline (6)
10. Tap *Accept* to confirm your selection.
 11. Press *Stakeout* to begin navigating using either the plan or *cross section* graphical display to navigate to the point.
 12. Mark the point with a stake.
 13. When the point has been marked, you can measure it as an *As-staked point* by tapping *Enter* to go into the *Stakeout / Point* screen.

String interpolation

The following rules apply to keyed-in station values:

- For a 6D string elevation values are computed by linear interpolation for station positions between the 6D points. However, if there is a 12D string coincident with the 6D string, the software uses the

vertical alignment data available in the 12D string to compute the elevation values for station positions between the 6D string points.

- For a 3D string elevation values are computed by linear interpolation for station positions between the 3D points.
- Interpolation between points along a spiral is calculated using a clothoid spiral for 12D and 6D strings and approximated for 3D strings.

When measuring your position relative to a GENIO road or where your station and offset are nominal values your position is computed by linear interpolation from the nearest positions on adjacent strings.

In all situations where your position is interpolated, closer station intervals give greater accuracy.

Staking Roads from LandXML Files

The Trimble Survey Controller software enables you to stake out a road from a LandXML file.

Only the road files in the current [project folder](#) are available for stake out.

To do this:

1. From the main menu, select *Survey / Survey style / Stakeout / Roads*.
2. Highlight the road name and tap *Stakeout*.
3. If the file contains multiple roads select the road to be staked. To view a list of available roads, tap the arrow and then select *List*.
4. Select the station to be staked from the *Stationing* field.
5. If the road contains multiple surfaces, select the surface to be staked out. To view the available surfaces, tap the arrow and then select *List*.
6. Enter a value in the *Antenna/Target height* field.
7. Select the offset to be staked out from the *Offset* field.
8. To edit the design elevation, tap the arrow. To reload an edited elevation, select *Reload original elevation* from the pop-up menu in the *Design elevation* field.
10. To apply construction offsets, tap and hold in the graphics window and then select *Construction offsets*.
11. Select *Start* and use the graphical display to navigate to the point.
12. To view the [cross section](#) of the selected station, tap *XS*.

To define a cross slope, see [Cross slope](#).

12. Mark the point with a stake.
13. When the point has been marked, you can measure it as an *As-staked point* by tapping *Enter* to go into the *Stakeout / Point* screen.

Note - You must specify a coordinate system before you can stake out roads with the Trimble Survey Controller software.

Warning - Do not stake out points and then change the coordinate system or perform a calibration. If you do,

these points will be inconsistent with the new coordinate system and any points computed or staked out after the change.

Selecting a station

You can select a station by one of the following methods:

- Select from the list in the *Stationing* field pop-up menu.
- Key in a value.

Note - Station equations are supported with the zone displayed after the station value.

Selecting an offset

You can select an offset by one of the following methods:

- In the *Offset* field, select *List* from the pop-up menu and then select from the list.
- Key in a value.

Enter a negative value for an offset to the left of the centerline; enter a positive value for an offset to the right of the centerline.

Note - You can key in a nominal station and offset to stake but, if the station value does not match those in the list, no surface will be available.

Specifying Construction Offsets

A point to be staked can be offset by a:

- [Horizontal offset](#)
- [Vertical offset](#)
- [Station offset](#) (available for roads from a GENIO file only)

When you stake a side slope, select the *Store both catch and construction offset* check box if you want to measure **and** store the catch position.

Tips

- Construction offsets are job-specific. That is, a construction offset specified for a road is not used for the same road when it is accessed from a different job.
- Construction offsets are format-specific. That is, a construction offset specified for a road is not used for roads of the other two road formats.
- Construction offsets are not road-specific. That is, a construction offset specified for a road is used for all roads of the same format in the same job.
- Construction offsets are not survey session-specific. That is, a construction offset specified for a road is used for subsequent survey sessions.

Horizontal construction offsets

You can offset a point horizontally where:

- A negative value offsets the point towards the centerline (in).
- A positive value offsets the point away from the centerline (out).

Use the advanced pop-up arrow () to specify if the offset is to be applied:

- horizontal
- at the slope of the previous element in the cross section
- at the slope of the next element in the cross section

The following diagram shows a *Horizontal offset(1)* , *Slope previous offset(2)* and *Slope next offset(3)* applied to a position. For the *Slope previous* option, the slope of the offset is defined by the slope of the element (4) before the position (5) selected to stake. For the *Slope next* option, the slope of the offset is defined by the slope of the element (4) after the position (6) selected to stake. The *Vertical offset* value in the diagram is 0.000.

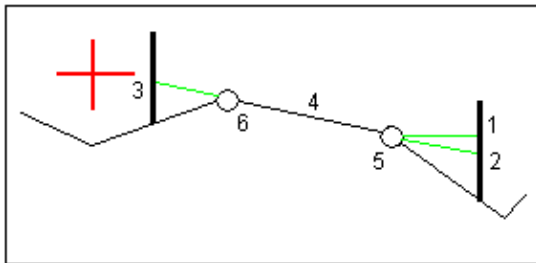

Note - For points with zero offset, you cannot apply construction horizontal offsets at the slope value of the previous template element.

Use the advanced pop-up arrow () to specify if the offset is to be applied:

- perpendicular to the master string for the sub string being staked
- perpendicular to the sub string being staked

The following diagram shows a *Horizontal offset(1)* applied perpendicular to the master string(2) and a *Horizontal offset(3)* applied perpendicular to the sub string(4).

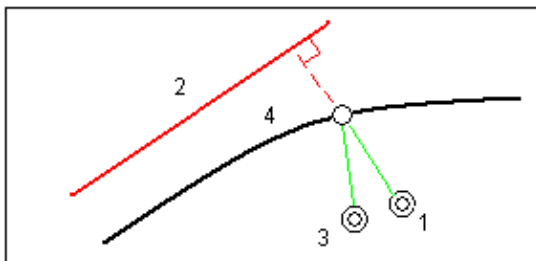

Tips

- For Trimble roads where the *Stake* option is *Nearest offset*, and an offset other than *Nearest* is selected, you can define a horizontal offset by your current position. To do this:
 - ◆ Use the advanced pop-up arrow () and select *Calculated*
 - ◆ Navigate to the position you want to place the stake. Note that the *Go left / Go right* navigation delta is replaced by the distance to the centerline when the horizontal offset is *Calculated*.
 - ◆ Measure and store the point

The calculated horizontal offset is reported in the *As staked deltas*.

- For GENIO roads where the stake option is *Station on string*, you can define a horizontal offset by the distance from the selected position to the master string. To do this:
 - ◆ Use the advanced pop-up arrow () and select *At string*
 - ◆ Navigate to the target which will be at the master string
 - ◆ Measure and store the point

The calculated horizontal offset is reported in the *As staked deltas*.

This option is not available if the string being staked is a 5D string or if the horizontal offset is applied perpendicular to the sub string.

- For GENIO roads where the stake option is *Station on string* or *Along string*, you can define a horizontal offset by the distance from the selected position to your current position. To do this:
 - ◆ Tap the advanced pop-up arrow () and then select *Calculated*.
 - ◆ Navigate to the position where you want to place the stake. Note that the *Go left / Go right* navigation delta is replaced by the calculated horizontal construction offset.
 - ◆ Measure and store the point

The calculated horizontal offset is reported in the *As staked deltas*.

This option is not available if the horizontal offset is applied perpendicular to the sub string.

Notes

- If you enter a value for the horizontal offset on the centerline (at offset 0.00 m), a negative value offset is to the left.
- Construction offsets are not automatically applied to a sideslope offset. For more information, see staking a [Catch point](#).

Vertical construction offsets

You can offset a point vertically where a:

- A negative value offsets the point vertically down.
- A positive value offsets the point vertically up.

In the *Vertical offset* field, use the advanced pop-up arrow () to specify if the offset is to be applied:

- vertically
- perpendicular to the element in the cross section before the point being staked

The following diagram shows a *Vertical offset* applied vertically(1) and a *Vertical offset* applied perpendicular(2) to the previous cross section element(3).

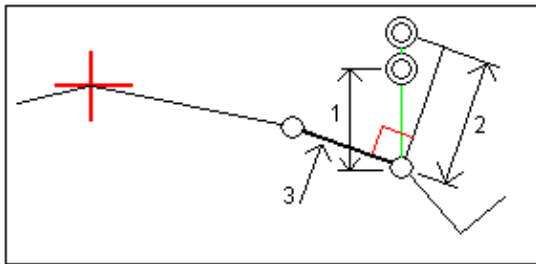

Station construction offsets

For roads derived from a GENIO file you can offset a point along the station of the selected string where a.

- A positive value offsets the point in the direction of increasing station (Forward).
- A negative value offsets the point in the direction of decreasing station (Backward).

Notes

- You cannot apply a Station offset to a 5D string that represents the catch position.
- The Station offset respects the geometry of the string being staked.

Cross Section View

For Trimble roads and roads from a LandXML file:

- Tap *XS* to view the cross section of the selected station.

For roads from a GENIO file:

- Tap the icon in the bottom right corner of the graphics window to change between the plan and cross section views.

The cross section that appears is orientated in the direction of increasing station. Your current position and the target are shown. If the target has construction offsets specified, the smaller single circle indicates the selected position and the double circle indicates the selected position adjusted for the specified construction offset(s). The construction offset(s) appear as green lines.

When you view the cross section, the appropriate cut or fill side slope appears for the side of the road that you are currently on.

For all road formats, see [Cross slope](#) to graphically define a cross slope.
 For roads defined in a GENIO file, see [Subgrade](#) to graphically define a subgrade.

Catch Point

The catch point is the point where the design side slope intersects with the ground.

The actual intersection position of the side slope with the existing ground surface - the catch point-is determined iteratively (by repetition). The Trimble Survey Controller software calculates the intersection of a horizontal plane passing through the current position, and either the cut or fill side slope, as shown in the following diagram , where x_n is the *Go Right/Left* value.

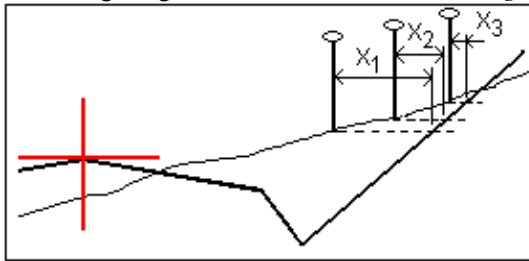

The graphical display in the plan view, shows the calculated catch position. The calculated slope value (in blue) and the design slope value appears at the top of the screen.

View the cross section for further graphical navigation. The cross section is displayed looking in the direction of increasing station. Your current position and the calculated target are indicated. A line is drawn (in blue) from the hinge position to your current position to indicate the calculated slope.

If the catch point has construction offsets specified, these appear in the cross-section view as green lines. The smaller single circle indicates the calculated catch position and the double circle indicates the selected position adjusted for the specified construction offset(s). The construction offsets appear only after you have applied them.

Note - For side slope offsets where the slope changes between templates, the Trimble Survey Controller software calculates the side slope for intermediate stations by interpolating the slope value.

From the *Confirm staked deltas* screen (or *Review current job*) tap [Report](#) to view the *Catch point deltas report* screen.

The Select softkey (applicable to Trimble roads only)

The following table explains the *Select* menu options for a side slope.

Option	Description
<i>Catch point (Auto)</i>	The Trimble Survey Controller software selects the side slope (cut or fill) to intersect with the ground. This is the default.
<i>Catch point</i>	Fixes the side slope as a cut side slope.

(Cut)	
Catch point (Fill)	Fixes the side slope as a fill side slope.
Hinge point (Cut)	Stakes out the base of the cut side slope. This is the most direct way to select the hinge point if the template includes a ditch offset.
Hinge point (Fill)	Stakes out the start of the fill side slope.

Catch Point Staked Deltas

If you have the *View before storage* check box in the *Stakeout* options selected, the *Confirm staked deltas* screen appears before you store the point.

Note - The value in the *S.dist to hinge + Constr off* field includes any construction offset values specified and reports the slope distance from the hinge to the as-staked position. The value is null (?) if there is no horizontal construction offset specified or the horizontal construction offset is applied horizontally.

Tip - Tap *Report* to view the *Catch point deltas report* screen. This screen shows the horizontal and vertical distances from the catch point to the end of each template element, up to and including the centerline. If the template includes a cut ditch, the report includes the hinge position at the toe of the cut slope. The reported values exclude any construction offset specified.

The following diagram explains some of these fields.

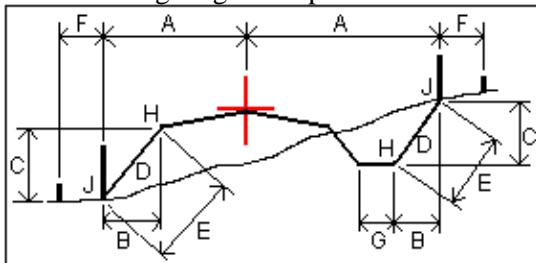

Where:

A	=	Distance to center line
B	=	Horizontal distance to hinge point
C	=	Vertical distance to hinge point
D	=	Slope
E	=	Slope distance to hinge point
F	=	Horizontal construction offset
G	=	Ditch offset
H	=	Hinge point
J	=	Catch point

The Trimble Survey Controller software supports user definable stakeout reports, which enable you to configure the display of staked information on the *Confirm staked deltas* screen that appears when you enable *View before storage*. For more information, see [As-Staked Point Details](#).

Defining a cross slope

You can use this special construction offsetting tool with Trimble, GENIO, and LandXML roads. Activate it graphically from the cross section view when in selection mode for GENIO roads and when in stakeout mode for Trimble and LandXML roads. Cross sloping enables you to stake two positions in a single operation, as shown in the following diagram:

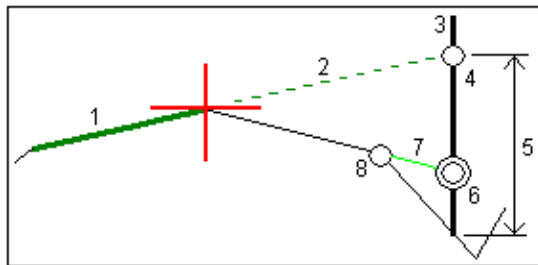

To do this:

1. From the cross section view tap and hold and select *Define construction offsets* and then select a horizontal offset method, typically *Slope*, and enter a horizontal offset.
2. The smaller single circle (8) indicates the selected position and the double circle (6) indicates the selected position adjusted for the specified construction offsets. The construction offset(s) appear as a green line (7).
3. Tap the line (1) that will define the cross slope. From the pop-up menu select *Define cross slope* and optionally enter a *Cross slope offset*.

Note - For Trimble and LandXML roads, when you tap the line, the system immediately defines the cross slope. There is no pop-up menu.

4. The selected line appears as a bold green line. A dashed green line (2) extends from the selected line to intersect with a vertical line (4) at the target stake (3).
5. Navigate to the target and then stake the position.
6. From the *Confirm staked deltas* screen use the *V.Dist. cross slope* value (5) to mark the stake with the second position.

Note - The defined cross slope applies to all subsequent stations. To de-activate the cross slope function, tap the selected line (1).

Defining a subgrade

This special subgrade calculation tool for GENIO roads is activated graphically from the cross section view when in selection mode. It enables you to stake a position at an offset to a line, as shown in the following

diagram:

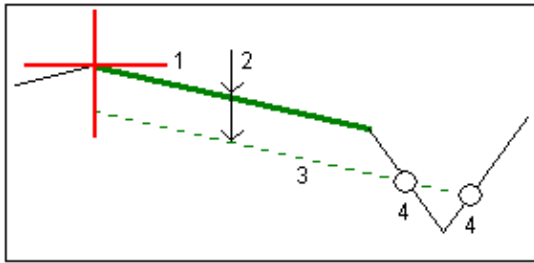

To do this:

1. From the cross section view, tap the line (1) that will define the subgrade. The selected line appears green and bolded.
2. From the pop-up menu, select *Define subgrade*.
3. Enter the depth to subgrade (2) where the depth is from the selected line to the subgrade surface.
4. The dashed green line (3) that appears is parallel to the line selected and offset by the depth to the subgrade. The line extends to intersect with all encountered lines in the cross section. The single circles (4) indicate the computed positions.
5. Tap the computed position that you want to stake.
6. Navigate to the target and then stake the position.

Note - The defined subgrade applies to all subsequent stations. To de-activate the subgrade function, tap the selected line (1).

Fine and Coarse Modes - GPS Stakeout

Choose either the fine or coarse mode when navigating to a point. Use *Fine* or *Coarse* in the *Stakeout* graphical display to change from one to the other:

- *Fine* appears when the Trimble Survey Controller software is in coarse mode. Tap it to go into fine mode.
The display updates at a rate of one position per second, and the precision of the position is higher.
- *Coarse* appears when the Trimble Survey Controller software is in fine mode. Tap it to go into coarse mode.

The display updates at a rate of five positions per second, and the precision of the position is lower.

Note - When you tap *Fine* the graphical display screen zooms in and magnifies the display by the zoom factor specified in the survey style.

Note - When you get within 1 foot (0.3048m) of the point, the stakeout mode will automatically change to fine mode. This can be disabled by unselecting the *Auto change to Fine* setting in the stakeout section of the RTK survey style.

Survey - Tunnels

Tunnel: Overview

Use the Tunnels option to scan or manually measure positions in a tunnel relative to a [keyed in](#) or [imported](#) tunnel definition.

Note - The survey tunnel functionality is available only if you have the Trimble Survey Controller Engineering option (PN 90100-02, 90100-03) enabled on your controller.

Keyed-in tunnels are saved to the current project folder as 'tunnel name'.txt. Tunnels are available for all jobs in the current project folder.

To use a file saved to the current project folder in another project, use Windows Explorer to copy or move the file to the appropriate project folder.

For more information on scanning positions in a tunnel, see [Auto scanning positions in a tunnel](#).

For more information on manually measuring positions in a tunnel, see [Manual measuring positions in a tunnel](#).

Notes

- The Trimble Survey Controller software defaults to tracking mode when scanning and measuring in a tunnel. If you select standard mode, you achieve better quality but slower measuring times.
- The Trimble Survey Controller software *Survey / Tunnel* option supports Trimble VX/S Series instruments.

Importing Tunnels

You can convert a LandXML file that defines a tunnel to a Trimble txt file for use in the Trimble Survey Controller software. The LandXML file is converted using the [ASCII File Generator] utility program (available on the Trimble Survey Controller CD).

Before you can convert a LandXML file, you must copy the [LandXML To TunnelXML.xsl] file from the [Trimble Survey Controller\Utilities\Export Definitions] folder on the Trimble Survey Controller CD to the [Trimble Survey Controller\Custom ASCII Files] folder on your office computer.

To convert a LandXML file to a txt file:

1. On the office computer, select [Start / Programs / Trimble Data Transfer / ASCII File Generator] to start the [ASCII File Generator] utility program.
2. From the *Source JobXML* or *Job file* field, select *Browse*. Set the *File of type* field to *All files*. Browse to the appropriate folder and then select the LandXML file to convert.

3. From the *Output format* field, select the [LandXML To TunnelXML] style sheet.
4. Select *OK*.
5. From the *User Value Input* screen, enter the index of the tunnel surface to be converted where the default index 1 is the first surface in the LandXML file, 2 is the second surface in the file, and so on.
6. Select *OK*.
7. Confirm the *Save in folder* and *File name* for the txt file and then select *Save*.
8. When done, select *Close*.

Use the ActiveSync technology to copy the txt file to the controller.

Tip - To create txt files for other surfaces in the LandXML file, repeat steps 1 through 8. Enter the appropriate index value for the tunnel surface.

Auto Scanning Positions in a Tunnel

Auto scan measures points at a defined scan interval for selected stations. The resulting positions are compared to the design template for that station.

Notes

- Auto scan defaults to tracking mode for each scan but will work in standard mode.
- When a scan starts, the DR target height and prism constant are automatically set to 0.00.

To auto scan positions in a tunnel:

1. From the main menu, select *Survey / Tunnels* and then select the tunnel name from the list. Tap *OK*. The plan view displays the horizontal alignment of the tunnel, and the instrument position and current direction. A black open circle indicates each station as defined by the station interval.

Note - The station interval is defined when you key in the start point for the horizontal alignment. See [keying in a horizontal alignment](#).

Tip - To add a station that is not defined by the station interval, tap and hold on the screen and then select *Add station* from the menu.

The mode defaults to *Auto scan*, as shown in the top left of the screen.

2. To define a scan, select stations to scan using one of the following methods:

- ◆ Tap and hold on the screen and then select from the list in the *Select stations* field.
- ◆ Tap individual stations.
- ◆ Drag a box around the stations.

Selected stations defining a scan are indicated as solid blue circles.

Tap a station to deselect it. Alternatively, tap and hold on the screen and then select *Clear selection* to clear all stations.

Note - Stations shown greyed out have no vertical alignment or no template assigned and cannot be selected for scanning.

Tip - As an alternative to defining a scan from the plan view, you can view a station to scan from the cross section view, tap and hold on the screen and then select *Scan current station*.

5. Tap *Start* and then set the *Start point name*, *Point code*, *Scan interval*, and *EDM timeout* from the *Settings* screen.
6. Tap *Accept* and then set the *Station*, *Overbreak*, and *Underbreak* tolerances from the *Tolerances* screen.
7. Tap *Accept*. The Trimble Survey Controller software begins scanning the first station.

Tap *Pause* to pause the scan; tap *Continue* to resume scanning. Tap *Stop* to end the scan before it is completed. While paused, you can select any scanned position to view the deltas.

Tip - To view the cross section that shows the design tunnel, points to be scanned, and the scanned positions, select the icon at the bottom right of the screen. Points to be scanned are defined by the scan interval, and include the start and end points that define each element in the template. For each scanned point, the overbreak, underbreak, and delta station values are displayed. Each scanned position appears as a green circle (if within tolerance), or a red circle (if not within tolerance).

Once all points for the current station are scanned, the Trimble Survey Controller software automatically advances to the next station until all selected stations are scanned.

Tip - When in the cross section view, tap the up arrow (next station) or tap the down arrow (previous station), to review other stations while still scanning. The station being scanned is indicated in the top left of the screen. The station being viewed is indicated at the top center of the screen.

8. Once all points for all selected stations are scanned, results show which stations have errors. You can expand stations with errors to see the number of points scanned, the number skipped, and the number of points outside tolerance. You can expand this last record to see the number of overbreak, underbreak, and delta station points.

Tip - The plan view shows the scanned stations. Stations with no errors appear as solid green circles, while those with errors appear as solid red circles.

9. Tap *Close* to finish.

Tip - After a scan is completed, you can do the following:

- ◆ To review a summary for each station, return to the plan view, tap and hold on the screen and then select *Results*.
- ◆ To see details for the displayed station, select *Details* from the cross section view. See also [Review tunnel](#).
- ◆ To edit the tolerance values, return to the plan view, tap and hold on the screen and then select *Tolerances*. The *Station*, *Overbreak*, and *Underbreak* deltas are updated to reflect the new tolerance values.

Manually Measuring Positions in a Tunnel

Use manual measurement to:

- **Measure** a position that could not be measured by a scan.
- **Delete** a scanned or manually measured position.

Manual measurement

To perform a manual measurement:

1. From the main menu, select *Survey / Tunnels* and then select the tunnel name from the list. Tap *OK*. The plan view of the tunnel appears.
2. Tap and hold on the screen and then select *Manual measure* from the pop up menu.

Tip - The measurement method appears in the top left of the screen.

3. Select a station to measure using one of the following methods:

- ◆ Tap and hold on the screen and then select a station from the list in the *Select stations* field.
- ◆ Tap an individual station.

The selected station appears as a red circle.

4. To view the cross section, select the icon at the bottom right of the screen.
5. Aim the instrument at the position you want to measure and then tap *Store*. Alternatively, tap the location that you want to measure. The instrument automatically turns to that position.

Deleting points

To delete a measured position:

1. From the cross section view, tap a point to select it. The selected point is indicated with a black circle.

To deselect the point, tap off it. Alternatively, tap and hold on the screen and then select *Clear selection*.

2. Tap *Delete*.

Tip - To restore deleted points, tap and hold on the screen and then select *Restore deleted points*.

Note - When you select a point for deletion, the instrument target will be the design position for that point. If you select *Store* immediately after deleting the point, the instrument remeasures the design position for the deleted point.

Reviewing Tunnels

To review a scan:

1. From the main menu, select *Files / Review tunnel* and then select the tunnel name from the list. Tap *OK*. The plan view of the tunnel appears.

Stations with no errors appear as solid green circles, while those with errors appear as solid red circles.

Tip - To see the overbreak, underbreak, and delta station tolerances specified for the scan, tap and hold on the screen.

2. To view a summary for each station, select *Results*.
 - ◆ To view the number of points scanned, the number of points within tolerance, and the number of points outside tolerance, expand the records for scanned stations.
 - ◆ To view the number of points in overbreak, underbreak, and delta station, you can expand the record for the number of points outside tolerance.
3. To view the current cross section showing the design tunnel and scanned positions, select the icon at the bottom right of the screen.
 - ◆ To see the overbreak, underbreak, and delta station values, select a scanned position.
 - ◆ Tap other points to view their details. Each scanned position appears as a green circle (if within tolerance) or a red circle (if not within tolerance).

Tip - To delete a selected point, tap the backspace key. Alternatively, tap and hold on the screen and then select *Delete point*. To restore deleted points, tap and hold on the screen and then select *Restore deleted points*.

Tip - To deselect it, tap off the point. Alternatively, tap and hold on the screen and then select *Clear selection*.

4. To view details for a selected point, tap *Details*. Each scanned point in the current cross section is listed and those with errors are indicated as outside tolerance. For each point, the offsets, grid, underbreak, overbreak, and delta station values are displayed.
 - ◆ To view the horizontal and vertical offsets from the intersection of the horizontal and vertical alignments to the scanned position, you can expand the *Offsets* record.
 - ◆ To view the north, east, and elevation values for the measured positions, you can expand the *Grid* record.

Tip - If you edit the tolerance values, the deltas are updated. To do this, tap and hold on the screen and then select *Tolerances*.

Note - All scanned and measured points are face 1 measurements and are stored in the database. To review them, go to [Files / Review current job](#).

Survey Configuration

Configuration Menu

Use this menu to:

- Change the language.
- Switch on or off sound events.
- Configure Bluetooth connections.
- Create and edit feature and attribute libraries.
- Create and edit survey styles.
- Create dial profiles for use with cellular modems.
- View the version number, serial number, authorization key and software warranty expiry.

For more information, see:

[Bluetooth](#)

[Feature and Attribute Library](#)

[Survey Styles](#)

[Dial Profiles](#)

[Options](#)

Survey Styles

Survey Styles define the parameters for configuring and communicating with your instruments, and for measuring and storing points. In a GPS survey, the Survey Style instructs the base and rover receivers to perform the functions required for a specific [survey type](#). This whole set of information is stored as a template that can be called up and re-used when necessary.

If there is only one survey style, it is automatically selected. Otherwise, choose one from the list that appears when you select *Configuration / Survey styles*.

You can use the styles supplied with the system without configuring them, but you can change default settings as required. The 5600 3600 style works with both the Trimble 5600 and Trimble 3600 instruments. Trimble Survey Controller detects the instrument that you are connected to and automatically configures the appropriate controls.

Set the appropriate [Options](#) to view and use Survey Styles.

To change the configuration of the Trimble Survey Controller software for different types of survey, select

Configuration / Survey Styles from the main menu.

For more information, see:

[Integrated Surveying](#)

[Conventional Survey](#)

[FastStatic Survey](#)

[Postprocessed Kinematic Survey](#)

[Real-Time Kinematic and Infill Survey](#)

[Real-Time Kinematic Survey](#)

[Real-Time Kinematic and Data Logging](#)

Software Options

To view a list of the available software options, select *Configuration / Options* from the main menu.

Some options are supplied as standard with all systems and can be enabled or disabled to show or hide functionality in the software. Other options are chargeable upgrades that can be changed only with an authorization key.

The following are standard options that are available with all systems:

- GPS surveying
- TS surveying
- [Advanced Geodetics support](#)

These options control the styles that are available and the relevant options that appear throughout the software. You can reconfigure the Trimble Survey Controller system at any time.

By default, all options are off. The GPS and TS survey style files are created in the [Trimble data] directory and are displayed only when these options are enabled.

Note - GPS surveying or TS surveying are automatically enabled when connecting to a GPS receiver or conventional instrument respectively.

You can set the software options and the [auto-connect](#) options independently of each other. For example, if you clear the *Trimble GPS receiver* check box in the *Auto connect options* dialog, that does not disable the *GPS surveying* option in the software *Options* dialog.

However, if the auto-connect options are disabled, then the software options cannot be automatically enabled, because it is the auto-connect process that detects the instrument and then configures the appropriate software

options.

Select *Advanced Geodetic support* to enable the following options:

- **Station setup scale factor**
- **Helmert transformation for Resection**

The following are chargeable upgrade options:

- Engineering
- High Accuracy GIS

Engineering option

With the Engineering option enabled, you can

- Automate rounds using a CSV file, which you can create at the end of the rounds, or on an office computer. The file contains all the relevant information about the points observed in the round
- Key in or import a tunnel definition and then automatically scan or manually measure positions in a tunnel relative to the tunnel definition

To order the Engineering option, contact your Trimble dealer:

Item	Part number
Engineering Option with the New Trimble Survey Controller	90100-03
Engineering Option with Existing Trimble Survey Controller (&supply the controller's serial number with order)	90100-02

High Accuracy GIS option

With the High Accuracy GIS option enabled:

- The 'file name' attribute fields include a **Browse** button that enables you to find and select a file name as an attribute.
- You can export ESRI shapefiles on the Trimble Survey Controller software using *Export fixed format file / ESRI Shapefiles*, or you can create ESRI Shapefiles using the Trimble Data Transfer utility.

To order the High Accuracy GIS option, contact your Trimble dealer:

Item	Part number
High Accuracy GIS Option with the New Trimble Survey Controller	90100-05
High Accuracy GIS Option with Existing Trimble Survey Controller (&supply the controller's serial number with order)	90100-04

Tap Upgrade to install a new option key for upgrading the software options.

Survey Types

Your GPS survey type will depend on available equipment, field conditions, and the results required. Configure the survey type when you create or edit a Survey Style.

To do this:

1. From the main menu, select *Configuration / Survey Styles / <Selected Survey Style> / Base options*.
2. Change the *Type* field as required.
3. Do the same for Rover options.

The Trimble Survey Controller software provides survey styles for the following survey types:

[Conventional Survey](#)

[FastStatic Survey](#)

[Real-Time Kinematic Survey](#)

[Real-Time Kinematic and Infill Survey](#)

[Postprocessed Kinematic Survey](#)

To use one of the following survey types, you must create your own survey style:

[Real-Time Kinematic and Data Logging](#)

[Real-Time Differential Survey](#)

For more information, see:

[Integrated Surveying](#)

Conventional Instrument - Configuration

Configure the conventional instrument type when you create or edit a Survey Style.

Select *Instrument*, choose the [instrument type](#), and then set the associated parameters.

Baud rate and parity

Use the *Baud rate* field to configure the Trimble Survey Controller baud rate to match that of the conventional instrument.

Use the *Parity* field to configure the Trimble Survey Controller parity to match that of the conventional instrument.

When you change the instrument type, the baud rate and parity settings automatically change to the default settings for the selected instrument.

HA VA status rate

Use the *HA VA status rate* field to set how often the Trimble Survey Controller software updates the horizontal and vertical angle display in the status line with information from the conventional instrument.

Note - Some instruments beep when communicating with the Trimble Survey Controller software. You can turn off the beep in the instrument or set the *HA VA status rate* to Never.

Measurement mode

The *Measurement mode* field appears if the selected instrument type has more than one measurement mode that can be set by Trimble Survey Controller. Use this mode to specify how the EDM measures distances. Options vary according to the instrument type. Select the *Instr. default* option to always use the setting on the instrument.

Tip - Tap Trimble functions to quickly change the measurement mode when using Trimble VX/S Series, 5600, 3600, and Leica TPS1100 instruments.

Trimble terminology matches the measurement modes on the Leica TPS1100 instruments as follows:

Trimble terminology	Leica terminology
STD	Standard
FSTD	Fast
TRK	Rapid tracking
DR	Reflectorless

Averaged Observations

Use the Averaged observations method to:

- increase the measurement precision with a predefined number of observations
- view the associated measurement standard deviations

While the instrument is carrying out the measurements, standard deviations are displayed for the horizontal (HA) and vertical (VA) angles, and the slope distance (SD).

Auto F1 / F2

When using a servo or robotic instrument, select the *Auto F1 / F2* check box to automatically measure a point on face 2 after the face 1 observation.

When *Auto F1 / F2* is selected, once the face 1 measurement is completed, the instrument automatically turns to face 2. The point name does not increment, which allows a face 2 observation to be measured with the same

point name as the face 1 observation. Once the face 2 measurement is completed, the instrument returns to face 1.

Auto F1 / F2 does not work when starting on face 2, or when the measurement method is set to:

- Angle offset
- H. Angle offset
- V. Angle offset
- Single dist. offset
- Dual-prism offset
- Circular object
- Remote object

Measure distance on face 2

The *Measure distance on face 2* option is used in:

- Measure topo, when *Auto F1 / F2* is selected
- Measure rounds, Station setup plus, and Resection, when a distance observation is not required on face 2

When the Measure distance on face 2 option is selected, if the face 1 measurement method included a distance measurement, then the measurement method for face 2 is automatically set to *Angles only* after the face 1 measurement. After the face 2 measurement, the instrument returns to the method used on face 1.

Set backsight

The *Set backsight* field appears if you can set the horizontal circle reading on the instrument when the backsight is observed. The options are *No*, *Zero*, and *Azimuth*. If you select the *Azimuth* option, when you observe the backsight the horizontal circle reading is set to the computed azimuth between the instrument point and the backsight point.

Servo auto turn

When using a servo instrument, the *Servo auto turn* field in the survey style can be set to *HA & VA*, *HA only*, or *Off*. If you select *HA & VA*, or *HA only*, the instrument automatically turns to the point during stakeout, and when a known point is entered into a point name field.

If you are working robotically, or when the *Servo auto turn* field in the survey style is set to *Off*, the instrument does not turn automatically. To turn the instrument to the angle indicated on the screen, tap *Turn*.

Centering error

The centering error is used to compute the observation weights as part of the Standard resection and Station Setup Plus computations. Set a value appropriate to the estimated accuracy of your instrument setup.

Instrument precision

Use the *Instrument precision* fields to record the precisions of the instrument. Do one of the following:

- Leave them as null.
- Enter the manufacturer's values.
- Enter your own values based on your observing techniques.

If you leave the fields as null, the statistics are computed using Trimble Geomatics Office default values. If you enter values, they are used to weight observations in the calculation of the Mean orientation and Scale factor for Multiple backsights and Resections, as well as the Resected position. They are also used in Trimble Geomatics Office to compute the standard error statistics for an observation.

When you use a Trimble VX/S Series, 5600, or 3600 instrument, the instrument precisions are not configured in the survey style. Trimble Survey Controller reads the instrument precisions from the instrument. These precisions are then used to weight and calculate the standard error statistics for an observation.

Observation standard error statistics are stored with each observation. The standard errors can be used in the office software to weight the observations during a network adjustment.

Conventional Instrument - Type

In a conventional survey style, you need to specify the type of instrument being used.

Choose a model made by one of the following manufacturers:

- Trimble
- Leica
- Nikon
- Pentax
- Sokkia
- Spectra Precision
- Topcon
- Zeiss

Choose *Manual* when you want to key in the measurements.

Choose one of the following SET types:

- SET (Basic), when using a Nikon instrument (if your instrument does not support a Nikon survey style). Make sure that the units on the instrument are the same as the units in Trimble Survey Controller.
- SET (Extended), when using any Sokkia instrument.

Tip - When using non-Trimble instruments, disable auto-connect. Some commands used by auto-connect can interfere with the communication of non-Trimble instruments.

Tip - Set the baud rate to 38400 to connect to the Nikon NPL-352 (or similar models).

Creating a survey style for the Leica TPS1100 and TPS1200 instruments for a Servo or Robotic Survey

The survey style configuration for a Leica TPS1100 and for a TPS1200 instrument are very similar except for the baud rates.

To create a survey style for a Leica 1100/1200 instrument:

1. From the main menu, select *Configuration / Survey Styles*.
2. Tap *New*.
3. Enter a name in the *Style name* field.
4. In the *Style type* field, select *Conventional* and then tap *Accept*.
5. Tap *Instrument*.
6. In the *Manufacturer* field, select *Leica*.
7. In the *Model* field, select either *TC1100 Servo (GeoCom)* or *TC1100 Robotic (GeoCom)*, depending on whether you will perform a servo or a robotic survey.
8. Set the *Baud rate* and *Parity* to match the settings on the instrument.
 - ◆ For the TPS1100 instrument, use a *Baud rate* of **19200** and *Parity* of *None*.
 - ◆ For the TPS1200 instrument, use a *Baud rate* of **115200** and *Parity* of *None*.

Trimble recommends an *HA VA status rate* of 2 seconds or slower. Faster rates can interfere with communication to the instrument.

For more information on *Send record acknowledgement*, see below.

Most of the other settings depend on how you want to use the software - configure them as required.

9. Tap *Accept* and then tap *Store* to save the changes.

Configuring a Leica TPS1200 Instrument for a Servo or Robotic Survey

In both servo and robotic surveys, Trimble Survey Controller communicates with a Leica TPS1200 instrument using the RCS (Remote Control Surveying) communication protocol through the GeoCOM mode interface.

To communicate with the TPS1200 instrument with a non-Leica controller, you must have the Leica GeoCOM Robotics License Key. You can make a connection to the instrument without the key, but many functions such as Lock, Search, Change face, and Turn to point will not work.

To configure the instrument:

1. From the Main menu on the Leica TPS1200, press 5 [Config...] and then press 4 [Interfaces...].
2. Use the keyboard arrow key to highlight these three devices; [GSI Output], [RCS Mode], and [Export Job], one-by-one and then press F5 [USE] to clear the currently selected devices, if required.
3. Use the keyboard arrow key to highlight [GeoCOM Mode] and then press F5 [USE] to set a [Device]. You need to set the device to [TCPS27] and configure the port settings. The device currently displayed may not be [TCPS27] but you will configure that in the next step.
4. To set the correct [Device], press F3 [EDIT] and then press F5 [DEVCE]. Press F6 [PAGE] until the [Radios] tab is highlighted and then use the arrow key to highlight [TPCS27].
5. Press F3 [EDIT] to configure the comms settings for the [TCPS27], as follows:

- ◆ [Baud Rate] = 115200
- ◆ [Parity] = None
- ◆ [Data Bits] = 8
- ◆ [Stop Bits] = 1

These are the default settings used with Leica 1200 TCPS27 radios, and these parameters will be set in the base radio connected to the Leica 1200 instrument. Make sure that the rover radio is configured to the same parameters.

Also make sure that the rover radio is set up as a [Remote] radio, the base radio is set up as a [Base] radio, and that they are both on the same [Link] frequency. You are using default settings so these parameters are probably already configured correctly, but if you have communication problems between the radios, check these settings.

To test if the radios are communicating, you can use the Microsoft HyperTerminal application, with each radio connected to a computer.

For more information, refer to your Leica manual or contact your Leica dealer.

6. To save the correct comms settings, press F1 [STORE] and then press F1 [CONT] to continue. The [GeoCOM Mode] screen now shows:
 - ◆ [Use Interface] = [Yes]
 - ◆ [Port] = [Port 1]
 - ◆ [Device] = [TCPS27]
 - ◆ [Protocol] = [RS232 GeoCOM]
7. To exit from the main menu, press F1 [CONT] two times.

The instrument is now configured for communication through the TCPS27 radios.

Note - You can communicate with the TPS1200 instrument regardless of the current screen displayed on the instrument - provided that the comms settings on the instrument, the radios, and the Trimble Survey Controller software are correct. This is different from the TPS1100 instrument.

Configuring a Leica TPS1100 Instrument for a Servo or Robotic Survey

In both a servo and robotic survey, Trimble Survey Controller communicates with a Leica TPS1100 model instrument using the RCS (Remote Control Surveying) protocol.

To configure the instrument:

1. From the Main menu on the Leica TPS1100, press 5 [Configuration] and then press 2 [Communication mode].
2. Press 1 [GSI parameters] and then set the [Baudrate] to 19200, [Protocol] to None, [Parity] to None, [Terminator] to CR/LF, and [Data Bits] to 8.
3. Press [Cont] to continue.
4. Press 5 [RCS (Remote) On/Off]. Make sure that [Remote control mode] is **off**.
5. To put the instrument in the [Measure and Record] screen, press F1 [Back] twice and then press F6 [Meas].

Note - You do not need to configure 2 [GeoCOM parameters], 4 [RCS parameters], and you do not need to put the instrument in [GeoCOM On-Line mode] or switch on RCS mode.

Tip - Trimble Survey Controller can only communicate with the instrument when the instrument is in the [Measure and Record] screen. To configure the instrument to start in the [Measure and Record] screen, select 5, 1, 04 from the main menu on the Leica instrument. Set the [Autoexec] to [Measure and record].

The Trimble Survey Controller software does not support the use of [ATR] mode during automated rounds. The [ATR] state is not updated during the round. Use [Lock] rather than [ATR] mode during automated rounds.

Tip - To use the Reflectorless technology of your instrument, configure the instrument to reflectorless. In Trimble Survey Controller, set the *Measurement mode* to *Instr. Default*. Alternatively, tap the Target icon in the status bar and select *Target DR* to switch to *Target DR* and automatically configure the instrument for reflectorless (DR) mode.

Note - Search does not work when the instrument is in reflectorless (DR) mode.

Note - The Leica TC/TPS1100 survey styles have been designed to operate specifically with the TPS1100 instruments. However, the TC/TPS1100 style may also be used to operate other Leica TPS instruments, for example the Leica TPS1200, using the same protocol.

Configuring a Leica TPS1100 instrument to record data to the Trimble Survey Controller software

You can configure a Leica TPS1100 instrument to trigger a measurement and then record the data to the Trimble Survey Controller software.

Note - Record mode is supported in the Trimble Survey Controller software only when using *Measure topo*.

To enable this function on the Leica instrument, you must [configure the format of the data](#) and then [configure where to send the data](#).

Configuring the format of the data

To configure the Rec-Mask so that the correct information is sent to the Trimble Survey Controller software:

1. From the Main menu on the Leica TPS1100, press 5 [Configuration] and then press 1 [Instrument config].
2. Press 05 [Display and Record].
3. Press F4 [RMask].
4. In the [Define] field, select an appropriate [Rec-Mask] to configure.
5. Set the [Mask name] to something appropriate.
6. Set the [REC format] to [GSI16 (16 char)].
7. The [1st word] is set to [Point Id (11)]. You can not change this.
8. Set the [2nd word] to [Hz (21)].
9. Set the [3rd word] to [V (22)].
10. Set the [4th word] to [Slope Dist (31)].
11. Set the [5th word] to [/(empty)].
12. Set the [6th word] to [Point Code (71)]. This step is optional.

When a point code is output from the instrument, it replaces the code in the code field in the *Measure topo* form.

To enter a Point code on the Leica instrument, you may need to configure the [Display mask](#).

13. Press [CONT] to continue.

On the [Main Display and Record] form the [REC-Mask] now appears with the name you gave the recording mask in step 5 above.

14. To return to the Main menu, press [CONT] / [BACK] / [BACK].

Configuring where to send the data

To configure the instrument to send the REC-Mask data to the RS232 port:

1. From the Main menu on the Leica TPS1100, press F5 [SETUP].
2. Set the [Meas job] field to [RS232 RS].

The [REC-Mask] field appears with the name you gave the recording mask in step 5 above.

3. To return to the [Measure &Record] screen, ready to start measuring points, press F6 [MEAS].

The Leica TPS1100 instrument is now configured to measure and send the point name, code, and measurement details to the Trimble Survey Controller *Measure topo* screen when you use F1 [All] on the Leica TPS1100 instrument.

Measure topo is the only place in the Trimble Survey Controller software where you can trigger a measurement on the Leica instruments and have the data stored to the controller.

Depending on the model (and possibly the firmware) of your instrument, you may need to configure the Trimble Survey Controller software. Some models require an acknowledgement from the controller that they have received the data.

If the instrument reports a comms error [Comm. error : wrong response.], and fails to increment the point name on the instrument, then you need to send an acknowledgement to the instrument.

To send an acknowledgement, select the *Send record acknowledgement* option in the Leica style, or in *Measure topo / Options*.

Note - If you selected the *Send record acknowledgement* check box, the status line in the Trimble Survey Controller software is disabled and the target icon is not updated with Lock status information from the instrument. View the Lock status through the instrument panel.

In the Trimble Survey Controller software, configure the *View before storage* field as required:

- When *View before storage* is on, the measurement details appear, and you can change the code field before storing the observation.

- When *View before storage* off, the measurement details appear briefly on the large button before the observation is stored.

Notes

- Records, 11, 21, 22, 31, and 71 (as described above) are the only records read by the Trimble Survey Controller software. All other records are ignored.
- The code field in the Leica software annotated [Point code] can be sent to the Trimble Survey Controller software.
- The code field in the Leica software annotated [Code] cannot be sent to the Trimble Survey Controller software.
- The point name must be defined in the Leica software and will always replace the point name in the *Measure topo* form. If *View before storage* is on, you do get the opportunity to change the point name.
- If the [Point code] has been defined in the Leica software it will always replace the Code in the *Measure topo* form.
- If the [Point code] is null in the Leica software it does not replace the code on the *Measure topo* form.
- If *View before storage* is on in the Trimble Survey Controller software, you can change the code before the observation is stored.
- When using *Auto F1/F2* the Trimble Survey Controller software does not increment the point name for the face 2 observation. This feature does not work if the point names are sent from the Leica instrument. For *Auto F1/F2* to work you must set the correct point names in the Leica instrument.

Configuring the display mask

To configure the Display mask so that the [Point code] field is available on the instrument:

1. From the Main menu on the Leica TPS1100, press 5 [Configuration] and then press 1 [Instrument config].
2. Press 05 [Display and Record].
3. Press F3 [DMask].
4. In the [Define] field, select an appropriate [Displ.Mask] to configure.
5. Set the [Mask name] to something appropriate.
6. Set the [word] corresponding to the position that you want the point code field displayed to [Point code].
7. Set the other [word] values as required.
8. Press [CONT] to continue.

On the [Main Display and Record] form the [Displ.Mask] now appears with the name you gave the display mask in step 5 above.

9. To return to the Main menu, press [CONT] / [BACK] / [BACK].

Laser Rangefinder

To measure points or distances using a laser rangefinder connected to the controller, first configure the laser

rangefinder in your Survey Style.

1. From the main menu, select *Configuration / Survey styles*. Highlight a survey style and tap *Edit*.
2. Select *Laser rangefinder*.
3. Select one of the instruments in the *Type* field.
4. If necessary, configure the *Controller port* and *Baud rate* fields.
The default value in the *Baud rate* field is the manufacturer's recommended setting. If the laser is a model with which the Trimble Survey Controller software can automatically take a measurement when you tap *Measure*, edit the *Auto measure* field.
5. If required, select the *Auto store* point check box.
6. Tap *Enter*. The precision fields contain the manufacturer's precision values for the laser. They are for information only.

The Trimble CU and TSC2 controllers support Bluetooth wireless connection to some laser rangefinders. If you use a Bluetooth wireless connection to a laser rangefinder, configure the Bluetooth wireless connection settings. For more information, see [To configure Trimble Survey Controller software to connect to a Bluetooth laser rangefinder](#).

Laser measurements can be displayed as vertical angles measured from the zenith or inclinations measured from horizontal. Select a display option in the Laser VA display field of the Units screen. For more information, see [System units](#).

Before using the laser with the controller, configure the laser options. The following table shows the configuration for each laser that is supported by Trimble Survey Controller.

Laser	Laser setting
Bosch DLE 150	When the Bosch DLE 150 is detected, an authentication request dialog appears. You must enter the PIN number set in the laser rangefinder.
LTI Criterion 300 or LTI Criterion 400	From the main menu, press the down arrow or up arrow key until the <i>Survey</i> menu appears and then tap <i>Enter</i> . Select <i>Basic measurements</i> and tap <i>Enter</i> . A screen showing the fields <i>HD</i> and <i>AZ</i> appears.
LTI Impulse	Set up the laser to operate in CR 400D format. Make sure that a small "d" is displayed on the screen. (If necessary, press the Fire2 button on the laser).
Laser Atlanta Advantage	Set the <i>Range/Mode</i> option to <i>Standard (Averaged)</i> and the <i>Serial/Format</i> option to <i>Trimble Pro XL</i> .
LaserCraft Contour XLR	Set the LaserCraft mode in the laser. If you connect through Bluetooth wireless technology, you also need to change the baud rate setting on the laser rangefinder to 4800.
Leica Disto memo/pro	Set the unit to meters or feet, not feet and inches.
Leica Disto Plus	You must enable Bluetooth wireless technology on the Leica Disto Plus before you run a Bluetooth scan. If automeasure is switched off: 1. To take the measurement, press the [Dist] key on the laser rangefinder. 2. Press the [2nd] key. 3. To transfer the measurement to the controller, press one of the eight direction arrow keys.

MDL Generation II	No special settings are required.
MDL LaserAce	Set the <i>Data record</i> format to <i>Mode 1</i> . When you use the angle encoder, set the magnetic declination to zero in the Trimble Survey Controller software. The angle encoder in the LaserAce laser corrects for the magnetic declination. Set the baud rate to 4800.

Note - You must configure the laser rangefinder to update the inclinometer and slope distance readings after each measurement.

Measuring laser points

During a survey, select *Measure laser points* from the *Survey* menu to measure laser points as offsets from a known point. Alternatively, to insert a distance into an *H.Dist* or a *Length* field, tap *Laser* from the pop-up menu and measure the distance with the laser.

If the *Auto measure* field in the survey style *Laser rangefinder* option is set to *Yes*, the Trimble Survey Controller software instructs the laser to take a measurement when you tap *Laser*.

If the Trimble Survey Controller software receives only a distance measurement from the laser, another screen is displayed with the measured distance in a *Slope distance* field. Enter a vertical angle if the measured distance was not horizontal.

Note - If you are using a laser without a compass, you must key in a magnetic azimuth before the Trimble Survey Controller software can store the point.

Note - Allow the laser to settle for a few seconds before you take a measurement with it. If you enter a value for magnetic declination in the laser, make sure the [Cogo setting](#) in the Trimble Survey Controller software is set to zero.

Duplicate Point Tolerance

In a GPS survey, when you attempt to add a point name, the Trimble Survey Controller software warns you if a point of the same name already exists.

In a conventional survey, when you attempt to add a point name that already exists, no message appears to warn you that the point already exists. This is because you may want to regularly measure points on both faces.

In a real-time GPS survey, or a conventional survey, you can set the tolerance for a duplicate point warning.

- Specify the maximum distance that a new point can be from an existing point.

In a conventional survey, only duplicate points from two separate station setups can be automatically averaged. Duplicate points from a single station setup are meant to create an MTA record. To average conventional observations from one station setup, set low duplicate point tolerances and select *Average* when the duplicate point warning appears. Alternatively, average using *COGO / Compute average*.

If the new point is further from the original point than the tolerance specified, you can choose what to do with the new point when you store it.

The options are:

- Discard
- Rename
- Overwrite - Overwrite and delete the original point, and all other points of the same name and the same (or lower) search class.
- Store as check - Store with a lower classification.
- Store another - Store the point, which can then be averaged in the office software. The original point is used in preference to this point.
- Average - Store the point and then compute and store the averaged position.

Note - When you select the *Average* option, the current observation is stored and the computed average **grid** position appears, along with the computed standard deviations for the north, east, and elevation ordinates. If there are more than two positions for the point, a *Details* softkey appears. Tap *Details* to view the residuals from the average position to each individual position. You can use this residuals form to include or exclude specific positions from the average computation.

To configure the Duplicate point tolerance:

1. Select the *Survey Style*.
2. Select *Duplicate point tolerance*.
3. Specify the horizontal and vertical tolerances. If you set these distances to zero, a warning is always given.
4. To automatically compute and store the average position, select the *Auto average* within tolerance option.

Note - When the *Auto average* option is checked, and an observation to a duplicate point is within the specified duplicate point tolerances, the observation and the computed average position (using all the available point positions) are automatically stored.

Note - The Trimble Survey Controller software computes an averaged coordinate by averaging the grid coordinates computed from the underlying coordinates or observations. Observations that do not allow a grid coordinate to be resolved (for example, angles only observations) are not included in the average coordinate.

Face 1 and Face 2 observations

When you carry out two-face observations in a conventional survey during *Station setup*, *Station Setup Plus*, *Resection*, or when measuring *Rounds*, the Trimble Survey Controller software checks that the Face 1 and the Face 2 observations to a point are within a preset tolerance.

If the observations are out of tolerance, the *Observation: Out of tolerance* screen appears.

The screen displays the following options:

- Discard - discard the observation without storing.
- Rename - rename to a different point name.
- Store as check - store with a classification of Check.

- Store another - store the observation.
- Store and reorient - (This option only appears if you are observing a backsight point.) Store another observation that will provide a new orientation for subsequent points measured in the current station setup. Previous observations are not changed.

Once you have completed the *Station Setup Plus*, *Resection*, or *Round* measurements, the Trimble Survey Controller software saves the Mean Turned Angles to each of the observed points. The software does not check for duplicate points at this stage. Therefore, to use any of the observations to compute an average position for an observed point, you must select the [Compute average](#) option from the *Cogo* menu.

Feature and Attribute Library

You can create a feature and attribute library by using office software and then transferring the library to the controller, or you can create a feature code list directly in the controller.

Note - Feature codes created using the Trimble Survey Controller software do not have attributes associated with them.

Use the following office software to create and transfer feature and attribute libraries:

To create the library, use ...	To transfer the library, use ..	File saved on controller as...
Feature and Attribute Editor	Trimble Geomatics Office	.fal
Feature Manager (Trimble Business Center)	Feature Manager	.fxl

Feature and attribute libraries created on the controller as saved as .fxl files.

There are up to five fields to configure when adding or editing feature codes. The options available depend on the type of file:

- All feature and attribute libraries have a *Feature code* and *Description*.
- All feature and attribute libraries have a *Feature type*. You can edit the *Feature type* in a .fal file, and you can set the *Feature type* when you create a new .fxl file, but you cannot edit the *Feature type* in a .fxl file once it has been set.
- All feature and attribute libraries have a *Line style*. There are only two line styles supported by the Trimble Survey Controller software, *Solid lines* and *Dashed lines*.
- Only .fxl feature and attribute libraries can have a *Line color*.

To create a new feature code list:

1. From the main menu, select *Configuration / Feature and attribute libraries*.
2. Tap *New*.
3. Enter the name of the list.
4. Tap the name of the new Feature and attribute file you just created and then tap *Edit* to add, delete, or edit codes.

Note - Feature codes cannot contain more than 20 characters.

Tip - The *Code* and *Description* are both displayed when you use Feature and attribute libraries. Most recently used codes are displayed indented at the top of the list.

Feature code names that contain spaces appear in the Trimble Survey Controller software with a small dot between the words, for example, Fire·Hydrant. These dots do not appear in the office software.

Some symbols are not supported in feature and attribute libraries, for example ! and []. If you use unsupported symbols when creating a library in the office software, the Trimble Survey Controller software converts them to the underscore symbol "_" when they are transferred.

Line codes

When it is operating with a feature code library, the Trimble Survey Controller software can process the feature codes so that points with their *Feature type* set to *Line* will be joined by lines.

To configure a feature and attribute library for real time feature code processing:

1. From the main menu, select *Configuration / Feature and attribute libraries*.
2. Select a *Line color* for the line.
3. Tap *Accept* and then tap *Store* to save the changes.

If the *Display coded features* option is selected in the map options, the Trimble Survey Controller software draws lines between points, based on the specified display properties.

Notes

- There are 15 basic colors available when configuring the line color in the Trimble Survey Controller software.
- Colors can be defined in the office using the Feature Manager software and transferred via an .fxl file to the controller. The colors defined in the .fxl file by the Feature Manager software may not be identical to the colors used by the Trimble Survey Controller software.
- Colors can be defined in the Feature Manager as 'By layer' or 'Custom'.
 - ◆ When 'By layer' has been defined the Trimble Survey Controller software uses black.
 - ◆ When 'Custom' has been defined the Trimble Survey Controller software uses the closest color match to the Trimble Survey Controller palette.
 - ◆ You cannot define the color as 'By layer' or 'Custom' in the Trimble Survey Controller software. If set in the office software, these options are displayed in the Trimble Survey Controller software, and can be changed to a Trimble Survey Controller software color, but if this is done you cannot change them back.

Control codes

With line codes set up in a feature and attribute library (as described above), points that have the same code can be joined by lines.

Example - In a topographical survey, set up the CL code as a *Line code* . Survey the center line of a road and assign the code CL to each point. If you have the *Display coded features* option selected, all points to which the code CL has been assigned are joined.

However, you will need extra line joining control to start new line sequences, close figures, and join specific points. To achieve this extra control, define *Control codes*. These are assigned to points in addition to the *Line code* of the point. A *Control code* follows the *Line code* it applies to and is separated from the *Line code* by a space character.

To create a *Control code*, set the *Feature type* for a code you are editing to *Control code*. When you have done this, a new *Control code action* is available.

The following control code actions are supported:

Control code	Action
Join to first (same code)	Joins the point to the first point that has the same code. Use this action in the definition of a control code that is used to close a figure.
Join to named point	Creates a line join from a point with this control code to the point named after this control code in the code field. The control code and name should be separated by a space. A line join created by this control code will be displayed in addition to the line join created by a line code that the control code may apply to.
Start join sequence	Starts a new join sequence. The current point is set as the first point in the sequence. As a result, the point that it will be joined to uses a control code with the action <i>Join to first (same code)</i> . This action also skips the join to the previous point with the same code that its associated line code would have created.
End join sequence	Instructs the system that the current point is the last point in the join sequence. This means that the next point that has the same line code will not join to it.
Skip join	Operates in a similar fashion to the <i>Start join sequence</i> action, but it only stops the join action of the line code it is associated with. It does not make the current point the first point in a new join sequence.

Note - Arcs are not currently supported.

Radios - for GPS

Radios are used for real-time surveys.

To connect a data link radio or cellular modem to the Trimble Survey Controller software, select the *Route through SC* check box. Real-time data between the receiver and the radio or cellular modem then passes through the Trimble Survey Controller software.

Specify the controller port that the radio or cellular modem is connected to, and the baud rate for communications.

A radio icon is displayed in the status bar when there is a radio link between the base and rover receivers. If there are fewer than 4 satellites, no position is computed and the radio icon disappears. If there is a problem,

various messages appear in the status line to give you extra information about the radio.

Configure the *Rover radio* or *Base radio* type when you create or edit the *Survey Style*.

Configuring a radio using the Trimble Survey Controller software

Use the Trimble Survey Controller software to:

- change the frequency of a radio.
- change the mode of a radio from a broadcasting/receiving radio to a repeater radio.
- change the wireless data rate.

To configure a radio:

1. Connect the controller, receiver, power, and radio. For more information, see the [diagram](#) on setting up the base receiver.

Alternatively, use a Y-cable to connect the power and the controller directly to the radio.

2. On the controller, highlight your survey style and tap *Edit*.
3. Select *Base radio* or *Rover radio* depending on which radio you are configuring.
4. Set the *Type* field and, if connecting directly, the *Controller port* field.

If connecting through a receiver, set the *Receiver port* field.

5. Tap *Connect*.

Note - If the softkey is not displayed, you cannot configure the type of radio you have selected.

If you are configuring a radio other than the internal radio of a Trimble R8, R7, R6, 5800, 5700, 4800, or 4700 GPS receiver, the following message appears:

Please confirm. Disconnect power from radio.

6. Disconnect the power from the radio and then tap *OK*.

The following message appears: *Please confirm. Connect power to radio.*

7. Reconnect the power to the radio and tap *OK* (there is no need to tap *OK* for a Pacific Crest radio).

The second *Base radio / Rover radio* screen appears.

8. Change the settings in the *Frequency* field and the *Base radio mode* field, as required.

The radio firmware version is also displayed.

9. Tap *Enter* when the details are correct (there is no need to tap *Enter* for a Pacific Crest radio).

Note - In some countries it is illegal to change the frequency of a radio. The Trimble Survey Controller software uses the latest GPS position to see if you are in one of these countries. If you are, only the available

frequencies are displayed in the *Frequency* field.

If your radio does not appear on the list, select *Custom radio* and then define the receiver port, baud rate, and parity.

If you select *Base radio* and set the *Type* field to *Custom radio* or *Cellular modem*, you can also enable *Clear To Send (CTS)*.

Warning - Do not enable CTS unless the receiver is connected to a radio that supports CTS.

The Trimble R8, R7, R6, 5800, 5700, 4800, and 4700 GPS receivers support RTS/CTS flow control when you enable CTS.

If you are using a 4700 or 4800 GPS receiver, use receiver firmware version 1.20 or later.

For more information on CTS support, refer to the documentation supplied with your receiver.

Radio Solutions

Trimble provides a comprehensive range of radio solutions that have been tested and proven. TRIMTALK radios are powered by the receiver's power supply using a common data/power cable. This configuration simplifies battery issues, as the receiver and the radio use the same power source. The Trimble R7, 5700, 4800 and 4700 GPS receivers can use a TRIMMARK III, TRIMMARK IIe or a TRIMTALK 450S radio at the base, and an internal radio at the rover.

You can use a [cellular modem](#) at both the base and rover receivers. At the base, the cellular modem is connected to the receiver. At the rover, the cellular modem can be connected to the receiver or the controller.

Note - Cellular modems used with the Trimble Survey Controller software must support Hayes compatible AT commands.

Base receivers used with modems must support CTS flow control.

You can use the Trimble Survey Controller software to configure the radios. For more information, see [Configuring a radio using the Trimble Survey Controller software](#).

Note - The 450 MHz internal radio in a Trimble R8 or R6 receiver can also operate as a base radio if it is configured as a transceiver. This avoids having to use an external radio solution at the base receiver to broadcast base data.

Radio considerations

Real-time survey methods rely on trouble-free radio transmission.

Note - The precision of measured points is not affected by radio performance.

To reduce the effects of interference from other base stations operating on the same frequency, use a transmission delay for your base station that does not coincide with others on the same frequency. For more information, see [Operating Several Base Stations on One Radio Frequency](#).

Sometimes the conditions or topography of a site adversely affect radio transmission, resulting in limited coverage.

To increase site coverage:

- Move the base stations to prominent points around the site.
- Erect the base radio antenna as high as possible.
- Use radio repeaters.

Tip - Double the height of the broadcast antenna to increase the coverage by approximately 40 %. To achieve the same effect, it would be necessary to quadruple the radio broadcast power.

Radio Repeaters

Radio repeaters increase the broadcast range of a base radio by receiving the base transmission and then rebroadcasting it on the same frequency.

Trimble provides five radio solutions for use with the Trimble Survey Controller system.

You can use one repeater with the TRIMTALK 450S (12.5 kHz) radio, and one or two repeaters with the TRIMTALK 450S (25 kHz) radio. For details of the TRIMMARK 3, TRIMMARK II / IIe, TRIMCOMM, and Pacific Crest radios, please refer to the specific product documentation.

You can configure the R8/R6 Trimble Internal radio to repeat base data to other rovers while performing a rover survey. This is known as a roving repeater setup. The internal radio can repeat the base signal over its UHF communication link to other rovers while simultaneously performing a rover survey. This option is available in R8 and R6 receivers with internal radios that are configured as transceivers. Select this repeater mode when you connect to the R8/R6 internal radio from the *Rover radio options* screen in the Survey Style.

Note - To use any of these radios as repeaters, they must be configured as repeaters. To do this, follow the steps above to connect to the radio and then choose a repeater mode, which appears if the radio you are connected to supports being a repeater. Alternatively, if the radio has a front panel, use that to set the repeater mode.

Cellular Modem - Overview

In a real-time survey, you can use an external cellular modem or Trimble Internal GSM/GPRS module as the corrections data link between the base and the rover receivers. You can also use an external cellular modem to connect to the Internet to exchange data and e-mail.

For information on connecting to an Internet Service Provider (ISP), refer to the Windows CE Help on the controller.

To perform an Internet real-time survey, use one of the following methods:

- Receive base data from a service provider, using a system such as GPSnet or GPSbase.
- Use your own remote base station that is also connected to the Internet by a cellular modem or

Trimble Internal GSM/GPRS module. If you use this method, you must have a Trimble Survey Controller data collector connected at all times at the base.

If you use your own base station connected to the Internet, you can set up the base station to operate as a server that the rover will connect to, or to transfer the data to a distribution server. When the base operates as a server, the number of rover connections to that base is limited by the capacity of the base Internet connection. In some cases, only one rover connection may be possible. When the base transfers data to a distribution server, the distribution server can send the base data to many rovers.

To use a cellular modem or Trimble Internal GSM/GPRS module to connect the controller to the Internet, see [Connecting to the Internet](#).

To use a cellular modem or Trimble Internal GSM/GPRS module in an Internet real-time survey, [configure](#) the base and rover radio as an Internet connection when you create or edit a Survey Style. The cellular modem must support an Internet connection.

You can use a cellular modem in dial-in mode to receive base data from a service provider that uses a modem as the service data link, or from a remote base station that is also equipped with a cellular modem. When you use your own base station, the rover cellular modem dials directly to the base cellular modem. The cellular modem can be connected to the receiver or to the controller. Alternatively, you can use the Trimble Internal GSM/GPRS module in a Trimble R8 receiver.

To use a cellular modem or Trimble Internal GSM/GPRS module in a dial-in real-time survey, [configure](#) the base and rover radio for a dial-in connection when you create or edit a Survey Style. The modem must support Hayes compatible AT commands.

Dial Profiles

If you use a cellular modem as the corrections data link for a real-time survey, you can create and configure the Internet or dial-in connection from *Configuration / Dial profiles*.

To access the dial profiles when you [configure the base or rover modem](#), tap the field menu (right arrow) on the *Dial profile* field.

To add, edit, or delete entries in dial profiles, tap *Configuration / Dial profiles* from the main menu.

Creating and configuring dial profiles

You can select a dial profile when you configure the rover radio for your survey style:

1. Create a survey style with one of the following rover radio types:
 - ◆ Cellular modem.
 - ◆ Internet connection.
 - ◆ Trimble internal - GPRS Internet.
 - ◆ Trimble internal - GSM dial-in.
2. In the *Dial profile* field that appears in the base/rover radio form, tap the field-menu (right arrow)

- button. The *Dial profiles* form appears.
3. Tap the required dial profile name.
The profile is automatically entered in the *Dial profile* field.

To create a new dial profile:

1. From the main menu, select *Configuration / Dial profiles*.
2. Tap *New*.
3. Enter the *Profile name* and *Profile type* and then enter all of the dial profile details. If you are using a Bluetooth modem, select one from the drop down list or tap *Config* to perform a Bluetooth scan.
4. Tap *Store*.

Note - You can also create and edit profiles by editing the [DialProfiles.xml] file that is stored in the [Trimble data] folder. To do this this, copy the file to your computer using ActiveSync technology, edit the file and then load it back into the [Trimble data] folder.

To delete a dial profile:

1. From the main menu, select *Configuration / Dial profiles*.
2. Highlight the entry that is to be deleted.
3. Tap *Delete*.
4. When asked if you want to permanently delete the profile, tap *Yes*.

To create an Internet connection using dial profiles:

1. From the main menu, select *Configuration / Dial profiles*.
2. Highlight a dial profile that is configured for an Internet connection.
3. Tap the *Connect* button at the bottom of the *Dial profiles* form. An Internet connection is established and a check mark appears next to the profile to show that it is in use.
4. To end the Internet connection, highlight the dial profile and then tap *Hang up*.

If you start a GPRS survey after you establish an Internet connection in *Dial profiles*, then the Trimble Survey Controller software uses this connection for the GPRS survey.

Cellular Modem Dial-in Survey Configuration

Configuring a Survey Style for a Cellular Modem Dial-in Real-Time Survey

Before you start a survey using a cellular modem connected to the controller with Bluetooth, make sure that the phone is paired with the controller.

Bluetooth pairing must establish that both the controller and the modem have permission to communicate with each other.

To start the pairing process with a Bluetooth modem:

1. Make sure that the phone is turned on and that it is in *discoverable* mode.
2. Select *Configuration / Controller / Bluetooth* and then click on the *Config* button to bring up the Bluetooth configuration screen for the controller.

Note - If you are using a Trimble R8 or R6 receiver with an Internal GSM/GPRS module, you do not need to scan for the module separately from the receiver. The Trimble R8/R6 receiver and the Internal GSM/GPRS module are recognized by a Bluetooth scan as being the same device but with serial port and dial-up networking capabilities.

To configure the base/rover radio for a cellular modem that uses a dial-in (circuit switched) connection to another modem:

1. From the main menu, select *Configuration / (Selected Survey Style) / Base/Rover radio*.
2. In the *Type* field, select *Cellular modem*.
3. If you are connecting the cellular modem directly to the controller using a cable or Bluetooth, select the *Route through SC* check box.
4. In the *Dial profile* field, select a profile.

Do one of the following:

- From the *Dial profile* field, tap the field menu (right arrow) button to access the [dial profiles](#) form. Select a dial profile from the list or create a new dial profile.
 - ◆ If you are configuring a rover modem, enter the phone number of the base station modem in the dial profile.
 - ◆ If you are connecting to a modem through Bluetooth wireless technology, make sure that you select the Bluetooth modem you are using in dial profile.
 - Enter the dial profile name for a profile that you have already configured.
5. To display the dial profile that is configured in the survey style, or change the dial profile when you start the survey, select the Prompt for dial profile check box.

Configuring a Survey Style for a Trimble Internal GSM/GPRS Module Dial-in Real-Time Survey

Before you start a survey using a Trimble Internal GSM/GPRS module:

1. Connect the controller to the Trimble R8 or R6 receiver that has an Internal GSM/GPRS module with Bluetooth technology installed.
2. Select *Configuration / Controller / Bluetooth*. In the *Connect to GPS receiver / VX/S Series* field, select the receiver.

To configure the base/rover radio for a Trimble Internal GSM/GPRS module that uses a dial-in (circuit switched) connection to another modem:

1. From the main menu, select *Configuration / (Selected Survey Style) / Base/Rover radio*.
2. In the *Type* field, select *Trimble Internal*.
3. In the *Method* field, select *GSM Dial-in*.
4. In the *Dial profile* field, select a profile.

Do one of the following:

- From the *Dial profile* field, tap the field menu (right arrow) button to access the [Dial profiles](#) form. Select a dial profile from the list or create a new dial profile.
 - ◆ Enter the phone number of the base station modem in the *Number to dial* field.
 - ◆ Select the name of the Trimble R8 receiver in the *Bluetooth modem* field.
 - Enter the dial profile name for a profile that you have already configured.
5. To display the dial profile that is configured in the survey style, or change the dial profile when you start the survey, select the Prompt for dial profile check box.

When you start a survey using the Trimble Internal GSM/GPRS module, Trimble Survey Controller software dials the base station's modem and then begins the survey. For more information, see [Starting a Real time survey using a dial-in GSM connection](#).

The following table shows cellular modem commands and information that may be useful when completing a new *Dial profile*.

Field	Information required	Functions of command
Modem PIN (optional)	Number (4-8 digits).	Unlocks the cellular modem.
Init string (optional)	Command Note - For the base modem, the command must leave the modem in auto-answer mode. Alternatively, set the auto-answer mode separately, using a Terminal program.	Starts communication and sets up modem options.
Hang up	Command	Ends communication.
Dial prefix	Command	Command used to initiate dialing number.
Number to dial	Phone number of the base station modem. Note - Use a comma (,) to send a short delay, for example, to separate the area code from the number.	-
Dial suffix (optional)	Command	Software sends to the modem after it has dialled the number.
-	Note - The Dial prefix, Number to dial, and Dial suffix values are concatenated to send to the modem.	-
Post connect (optional)	Once the connection is established between the base and rover modems, information is sent from the rover to the base. This is usually the log-in name and password. Note - Use a caret (^) to send a carriage return and a 3-second delay to the base system. For example, use this to separate a log-in name from a password.	-

For information on starting a Real-time survey using a cellular modem, see:

[Starting the Base Receiver](#)

[Starting a Real-time Survey using a Cellular Modem](#)

[Starting a Wide-Area RTK Survey](#)

Cellular Modem Internet Survey Configuration

Configuring a Survey Style for an External Internet Real-Time Survey

To configure the base/rover radio to use an external Internet connection:

1. From the main menu, select *Configuration / (Selected Survey Style) / Base/Rover radio*.
2. In the *Type* field, select *Internet connection*.
3. In the *Dial profile* field, select a profile for the connection type.

Do one of the following:

- From the *Dial profile* field, tap the field menu (right arrow) button to access the [dial profiles](#) form. Select a dial profile from the list or create a new profile.
 - Enter the dial profile name for a profile that you have already configured.
4. To display the dial profile that is configured in the survey style, or change the dial profile when you start the survey, select the *Prompt for dial profile* check box.

To configure a new dial profile to use an external Internet connection:

1. Do one of the following:
 - If you are configuring a rover connection, enter the *IP Address* and *IP Port* number of the server you are connecting to as a source for base data into the *Edit dial profile* form.
 - If you are configuring a base connection to operate as a server, enter the *IP Port* number the rover will connect to into the *Edit dial profile* form. Enter this same *IP Port* number when you configure the rover survey style.
 - If you are configuring a base connection to upload to a remote server, enter the *IP Address* and *IP Port* of the remote server into the *Edit dial profile* form.

Obtain the IP address of the base from the Internet GPS correction data provider, or the IP address of the controller (if you are using a controller at the Internet base).

2. If the rover is to connect to the base through [NTRIP](#), select the *Use NTRIP* check box. If required, enter an NTRIP username and password. The proxy server check box appears when you select the

- NTRIP check box. If the rover is to connect to the proxy server, select the check box and then enter the proxy server address and port.
3. If the rover must supply identification information through regular NMEA messages to the base data server, select the *Send user identity info* check box. At the start of the survey, the software asks you to enter this information.
 4. In the *Use connection* field, key in a network connection or select one from the pop up directory. To create a network connection, see [Connecting to the Internet](#).
 5. In the *Connection type* field select the method your modem uses to connect to the Internet:
 - If your modem uses GPRS, select *GPRS*.
 - If your device is a CDPD modem, select *CDPD*.
 - If you are using a dial-up Internet connection where a phone number is used to dial your ISP, then select *Dial-up*.
 6. If required, enter the *Modem PIN* and Access Point Name (APN) for the external modem.
 7. If your GPRS provider requires a user name and password for a network connection, select the *Show connect dialogue* check box in your dial profile. The system prompts you to enter a user name and password before it establishes a network connection.

Note - The PPC operating system on the TSC2 controller does not support the *Show Connect* check box. This is because you can now specify a username and password when you create the DUN connection. These settings are saved on the controller so that you do not need to enter them each time you connect.

Note - If you are connecting to a cellphone through Bluetooth for an Internet connection, you must select the cellphone in the *Bluetooth modem* field of the *Edit dial profile* form.

Configuring a Survey Style for a Trimble Internal GSM/GPRS Module Internet Real-Time Survey

Note – To use the Trimble Internal GSM/GPRS module for Internet real-time surveys, connect the controller to the receiver using Bluetooth.

To configure the base/rover radio of a Trimble Internal GSM/GPRS module to use an Internet connection:

1. From the main menu, select *Configuration/ (Selected Survey Style) / Base/Rover radio*.
2. In the *Type* field, select *Trimble internal*.
3. In the *Method* field, select *GPRS internet*.
4. In the *Dial profile* field, select a profile for the connection type.

Do one of the following:

- From the *Dial profile* field, tap the field menu (right arrow) button to access the [dial profiles](#) form. Select a dial profile from the list or create a new profile.
 - Enter the dial profile name for a profile that you have already configured.
5. To display the dial profile that is configured in the survey style, or change the dial profile when you start the survey, select the Prompt for dial profile check box.

To configure a new dial profile to use a Trimble Internal Internet connection:

1. Do one of the following:

- If you are configuring a rover connection, enter the *IP Address* and *IP Port* of the server you are connecting to as a source for base data into the *Edit dial profile* form.
- If you are configuring a base connection to operate as a server, enter the *IP Port* number the rover will connect to into the *Edit dial profile* form. Enter this same *IP Port* number when you configure the rover Survey Style.
- If you are configuring a base connection to transfer to a remote server, enter the *IP Address* and *IP Port* of the remote server into the *Edit dial profile* form.

Obtain the IP address of the base from the Internet GPS correction data provider, or the IP address of the controller (if you are using a controller at the Internet base).

2. If required, enter the *Modem PIN* and Access Point Name (APN) for the external modem.
3. If the rover is to connect to the base through **NTRIP**, select the *Use NTRIP* check box. If required, enter an NTRIP username and password. The proxy server check box appears when you select the NTRIP check box. If the rover is to connect to the proxy server, select the check box and then enter the proxy server address and port.
4. If the rover must supply identification information through regular NMEA messages to the base data server, select the *Send user identity info* check box. At the start of the survey, the software asks you to enter this information.
5. If your GPRS provider requires a username and password for a network connection, select the *Show connect dialogue* check box. The system prompts you to enter a username and password before it establishes a network connection.
6. In the *Use connection* field, key in a network connection or select one from the pop up directory. To create a network connection, see [Connecting to the Internet](#).

When you start the survey, Trimble Survey Controller establishes a network connection with the Trimble Internal GSM/GPRS module and then begins the survey. For more information, see [Starting a Real time survey using a GPRS internet connection](#).

Note - The *Access Point Name (APN)* that you key in provides network routing and connection information for the service being requested. You can obtain this information from your GPRS service provider.

Note - If the IP address of the base controller appears to be invalid, Trimble recommends that you perform a soft reset of the device before you connect to the Internet and start the base.

Note - If you are using the R8 or R6 Trimble Internal modem for an Internet connection and you are connected to the receiver through Bluetooth wireless technology, you must select the receiver in the *Bluetooth modem* field of the *Edit dial profile* form.

Networked Transport of RTCM via Internet Protocol (NTRIP)

NTRIP uses the Internet to distribute real-time GPS base station data.

Configure the dial profile for a [Cellular Modem Internet Survey](#).

When the dial profile is correctly configured and you start the survey, a connection is established to the NTRIP server. In addition, a table appears showing the available sources of corrections from the server. These can be single station sources, or network sources (for example, VRS). The type of base station data that this "mount point" provides is shown in the source table. Select the source that you want to use. When you do this, a connection is made to that source, and base station data begins to stream through Trimble Survey Controller to the connected GPS receiver.

Note - To determine the closest source, tap the *Distance from here* heading to sort that column.

If authentication is required to connect to a particular mount point, and this was not configured in the dial profile, the Trimble Survey Controller software displays a screen where you can enter your user name and password.

Connecting to the Internet

To connect to the Internet, you need a cellular modem (typically, a cell phone). The cellular modem can be connected to the controller by Bluetooth wireless technology or by cable.

To connect by cable, use the cellular modem data cable connected to the serial port on the controller. Then create a [new dialing location](#) and [dial-up connection](#).

To connect to the Internet using a Bluetooth cellular modem:

A Bluetooth cellular modem can connect to a Trimble CU or TSC2 controller.

1. Make sure that Bluetooth is enabled, and that the cellular modem is paired and connected. For more information, see [Bluetooth](#).
2. On the controller, run the application [Bluetooth2Mobile] to associate your phone with Dial-up networking.
 - On the Trimble CU, double-tap [My computer] and browse to \Program Files\Survey Controller\, then double-tap Bluetooth2Mobile.exe.
 - On the TSC2 controller, skip this step and go straight to creating a new [dial-up connection](#).
3. Select your cellular modem from the drop down list. Tap [Hide] to minimize the application to the toolbar. Then follow the remaining steps below.

Note - You cannot connect to the Internet using the Trimble Internal GSM / GPRS module unless the controller is running the Trimble Survey Controller software.

To create a new dialing location on a Trimble CU controller:

1. On the controller, tap [Start / Settings / Control Panel / Dialing].
2. Tap [New]. Enter an appropriate name for the dialing location and then tap [OK].
3. Edit the [Dial patterns]:

- On the Trimble CU, tap [Edit].
4. Set the [Local], [Long distance], and [International calls] fields all to "g". Tap [OK].
This ensures that the controller does not add any automatic long distance or area codes to the number that it dials.

To create a new Dial-up Connection on a Trimble CU controller:

1. On the controller, tap [Start / Settings / Control Panel / Network and Dial-up Connections].
2. Double tap [Make new Connection]. Enter a connection name.
3. Make sure that the connection type is set to [Dial-up Connection]. Tap [Next].
4. Do one of the following:
 - ◆ If you are using Bluetooth wireless technology, select [BluetoothDUN].
 - ◆ If you are using a cable, select either [Com1: Hayes Compatible] or [Com2: Hayes Compatible].

Note - Do not change the settings on the [Configure], [TC/IP Settings] or [Security Settings] softkeys. The windows defaults are correct.

5. Tap [Next].
6. In the [Phone number] dialog, enter the number to dial:
 - ◆ If you are dialing a GSM provider (pay by the minute), enter the number to dial.
 - ◆ If you are dialing a GPRS provider (pay by volume of data transferred), enter *99***1#. The *99***1# is a standard access code for GPRS. If you are unable to connect using *99***1#, contact your GPRS provider.

To create a new Dial-up Connection on the Trimble TSC2 controller:

1. On the controller, tap [Start / Settings / Connections].
2. Tap the Connections icon and then select [Add a new modem connection] under [My ISP].
3. Enter a name for the connection.
 - ◆ If you are using Bluetooth wireless technology, select [Bluetooth], and then tap [Next].
 - ◆ If you are using a cable, select [Hayes Compatible on COM1], and then tap [Next].
 - ◆ If you are using a GPRS CF card, select [GPRS modem], and then tap [Next].
4. If you are using Bluetooth, select the cellular modem that you paired with the TSC2 controller earlier and then tap [Next].
5. Enter the number to dial:
 - ◆ If you are dialing a GSM provider (pay by the minute), enter the number to dial.
 - ◆ If you are dialing a GPRS provider (pay by volume of data transferred), enter *99***1#. *99***1# is a standard access code for GPRS.
If you cannot connect using *99***1#, contact your GPRS provider.

Note - If you travel or change area codes often, you can configure the dialing location. Select [Use dialing rules] when you enter the phone number:

1. Select the [Use dialing rules] link.

2. Select the [Use dialing rules] check box and then tap [OK] when the warning message appears.
3. To change the Trimble Survey Controller dialing rules, tap [Edit].
4. Select [Dialing Patterns] and then set the [Local], [Long distance], and [International calls] fields all to "g". Tap [OK].
This ensures that the controller does not add any automatic long distance or area codes to the number that it dials.
5. Once the dialing rules are updated tap [OK], to return to the form where you entered the phone number.
6. Tap [Next].

Note - Do not change the settings under the [Advanced] softkey. The defaults are correct.

7. Tap [Finish].

To start the Internet connection on the Trimble CU controller:

1. Make sure that the cellular modem is switched on and connected to the controller.
2. On the controller, tap [Start / Settings / Network/Dial-up Connections].
3. Double tap the new connection that you created earlier.
4. If necessary, enter the [User Name] and [Password] required by your GPRS provider to log onto their network. Many providers do not require a user name or password.
5. Tap [Connect].
6. When you are connected, tap [Hide].

Tip - To check that you are connected to the Internet, tap [Start / Programs / Internet Explorer] and visit a website, for example, www.trimble.com

To configure an Internet Real-Time Survey see [Configuring a Survey Style for an Internet Real-Time Survey](#).

To start the Internet connection on the Trimble TSC2 controller:

1. Make sure that the cellular modem is switched on and connected to the controller.
2. On the controller, tap [Start / Settings / Connections].
3. Tap the [Connections] icon and then select [Manage existing connections] under [My ISP].
4. Tap and hold on the new connection that you created previously and then select [Connect] from the shortcut menu.
5. If necessary, enter the [User Name] and [Password] required by your GPRS provider to log onto their network. Many providers do not require a user name or password.
6. Tap [OK].
7. When you are connected, tap [Hide].

Tip - To check that you are connected to the Internet, tap [Start / Programs / Internet Explorer] and visit a website, for example, www.trimble.com

To configure an Internet Real-Time Survey see [Configuring a Survey Style for an Internet Real-Time Survey](#).

To browse the Internet with a TSC2 controller during a GPRS connection:

1. On the controller, tap [Start / Settings / Connections tab / Connections / Advanced tab].
2. Tap [Select Networks].
3. Set [Programs that automatically connect to a private network should connect using:] to [My ISP].
4. Tap [OK] to save the changes and exit.

To send a message or a file from your controller to another computer see [Email](#).

Bluetooth

You can configure a Trimble controller (Trimble CU, TSC2) to connect to other devices using Bluetooth wireless technology.

On the controller, you can establish a connection to:

- Another Trimble controller
- A Trimble R8, R6, or 5800 GPS receiver
- A Trimble VX/S Series instrument
- A Bluetooth capable PC
- Supported Bluetooth laser rangefinders

Note - If you use a TSC2 controller, Trimble recommends that you do not alter the settings in the [COM ports] tab of the [Bluetooth] settings dialog.

To configure Bluetooth wireless technology to turn on by default after the TSC2 controller is reset:

Note - Bluetooth must have been turned on before the reset.

1. Tap [Start / Settings / Personal / Today] and then select the [Items] tab.
2. From the list of available options, select Trimble Survey Controller and then tap [Options].
3. Select [Enable Bluetooth after reset].
4. Tap [OK] to save the changes.

To configure one controller to connect to another controller:

1. Switch on both controllers.
2. On both controllers, start the Trimble Survey Controller software and then select *Configuration / Controller / Bluetooth* from the main menu.
3. On both controllers, tap *Config*.
 - ◆ On a TSC2 controller, make sure that the [Turn on Bluetooth] and [Make this device discoverable to other devices] check boxes are selected.
 - ◆ On a Trimble CU make sure that the [Enable Bluetooth] check box is selected.
4. Start a scan on **one** controller:
 - ◆ On a TSC2 controller, tap the [Devices] tab and then tap [New Partnership...].
 - ◆ On a Trimble CU controller, tap [Scan].

(Do not use [Stop] - wait for the scan to complete.)

The Trimble Survey Controller software searches for other Bluetooth wireless technology devices within range.

Do not perform a scan on more than one controller at a time. A Bluetooth device cannot respond if it is scanning.

5. Once the scan is complete, highlight the Bluetooth device to connect to
 - ◆ On a TSC2 controller, tap [Next].

When connecting one controller to another controller, you do not need to enter a passkey. Tap [Next].

Enter a display name for the device and then tap [Finish].

- ◆ On a Trimble CU controller, tap the --> softkey to make it a Trusted device.

When connecting one controller to another controller, you do not need to Authenticate the device. When the authentication message appears, tap [No].

6. On both controllers, tap [OK] to return to the Trimble Survey Controller software.
7. On the controller that is **sending** the data, select the controller you are sending to in the *Send ASCII data to* field. Tap *Accept*.

The controllers are now configured to [send and receive](#) ASCII data.

Note - You can give your controller a unique name. This makes it easier to identify when searching for it in a Bluetooth scan. To do this:

- On a TSC2 controller, go to [Start \ Settings \ System \ About]. Tap the [Device ID] tab and change the [Device Name] field, and then tap [Ok]. Press and hold the power key to perform a soft reset on the controller.
- On a Trimble CU controller, go to [Start \ Settings \ Control Panel \ System]. Tap the [Device Name] tab and change the [Device name] field, and then tap [Ok]. To reset the controller, go to [Start \ Programs \ Utilities\Reset \ Soft Reset].

To configure Trimble Survey Controller software to connect to a Trimble R8, R6, or 5800 GPS receiver:

1. Switch on the receiver and the controller.
2. Start the Trimble Survey Controller software and then select [Configuration / Controller / Bluetooth] from the main menu.
3. Tap *Config* and ensure that the Bluetooth wireless technology is switched on:
 - ◆ On a TSC2 controller, make sure that the [Turn on Bluetooth] and [Make this device discoverable to other devices] check boxes are selected.
 - ◆ On a Trimble CU controller, make sure that the [Enable Bluetooth] check box is selected.
4. Start a scan on the controller:
 - ◆ On a TSC2 controller, tap the [Devices] tab and then tap [New Partnership...].

- ◆ On a Trimble CU, tap [Scan].
(Do not use [Stop] - wait for the scan to complete.)

The Trimble Survey Controller software searches for other Bluetooth devices within range. A Trimble R8, R6, or 5800 GPS receiver does not respond to a scan if it is already connected through Bluetooth wireless technology.

5. Once the scan is complete, highlight the Bluetooth device to connect to.
 - ◆ On a TSC2 controller, tap [Next].

When connecting a controller to a Trimble R8, R6, or 5800 GPS receiver, you do not need to enter a passkey. Tap [Next].

Enter a display name for the device and then tap [Finish].

- ◆ On a Trimble CU controller, tap the --> softkey to make it a Trusted device.

When connecting a controller to a Trimble R8, R6, or 5800 GPS receiver, you do not need to Authenticate the device. When the authentication message appears, tap [No].

6. Tap [OK] to return to the Trimble Survey Controller software.
7. In the *Connect to GPS receiver / VX/S Series* field, select the Trusted Bluetooth device to connect to and then tap *Accept*.
The Trimble Survey Controller software automatically connects to the Trimble R8, R6, or 5800 GPS receiver within a few seconds.

Note - Unless you change the *Connect to GPS receiver / VX/S Series* fields to None, you do not need to use the scan function again. The controller automatically connects to the receiver when you turn on both devices.

To configure Trimble Survey Controller software to connect to a Trimble VX/S Series instrument:

1. Turn on the Trimble VX/S Series instrument and then use the Face 2 display on the instrument to turn on Bluetooth wireless technology.

Note - The menu of the Face 2 display on instrument can only be accessed when the instrument is On **and** the Trimble Survey Controller software is **not** connected. From the electronic level screen, select [Set] to access the menu and configure Bluetooth wireless technology.

2. Start the Trimble Survey Controller software and then select [Configuration / Controller / Bluetooth] from the main menu.
3. Tap *Config* and ensure that the Bluetooth wireless technology is switched on:
 - ◆ On a TSC2 controller, make sure that the [Turn on Bluetooth] and [Make this device discoverable to other devices] check boxes are selected.
 - ◆ On a Trimble CU controller, make sure that the [Enable Bluetooth] check box is selected.
4. Start a scan on the controller:
 - ◆ On a TSC2 controller, tap the [Devices] tab and then tap [New Partnership...].
 - ◆ On a Trimble CU controller, tap [Scan].
(Do not use [Stop] - wait for the scan to complete.)

The Trimble Survey Controller software searches for other Bluetooth devices within range. A Trimble VX/S Series instrument does not respond to a scan if it is already connected through Bluetooth wireless technology.

5. Once the scan is complete, highlight the Bluetooth device to connect to.
 - ◆ On a TSC2 controller, tap [Next].
When connecting a controller to a Trimble VX/S Series instrument, you do not need to enter a passkey. Tap [Next].
Enter a display name for the device and then tap [Finish].

Warning - While you are configuring the Bluetooth connection on a TSC2 controller, if a message says that the instrument wants to connect to the controller and asks if you want to add the instrument to your list of devices, tap [No].
 - ◆ On a Trimble CU controller, tap the --> softkey to make it a Trusted device.
When you connect a controller to a Trimble VX/S Series instrument, you do not need to authenticate the controller. When the authentication message appears, tap [No].
6. Tap [OK] to return to the Trimble Survey Controller software.
7. In the *Connect to GPS receiver / VX/S Series* field, select the Trusted Bluetooth device to connect to and then tap *Accept*.
The Trimble Survey Controller software automatically connects to the Trimble VX/S Series instrument within a few seconds.

Note - Unless you change the *Connect to GPS receiver / VX/S Series* fields to None, you do not need to use the scan function again. The controller automatically connects to the receiver when you turn on both devices.

To configure Trimble Survey Controller software to connect to a Bluetooth cellular modem:

1. Switch on the cellular modem and the controller.
2. On the cellular modem, select the option to make the cellular modem discoverable.
3. Start the Trimble Survey Controller software and then select [Configuration / Controller / Bluetooth] from the main menu.
4. Tap *Config* and make sure that the Bluetooth wireless technology is switched on:
 - ◆ On a TSC2 controller, make sure that the [Turn on Bluetooth] and [Make this device discoverable to other devices] check boxes are selected.
 - ◆ On a Trimble CU controller, make sure that the [Enable Bluetooth] check box is selected.
5. Start a scan on the controller:
 - ◆ On a TSC2 controller, tap the [Devices] tab and then tap [New Partnership...].
 - ◆ On a Trimble CU controller, tap [Scan].
(Do not use [Stop] - wait for the scan to complete.)
6. Once the scan is complete, highlight the cellular modem in the list of devices.
 - ◆ On a TSC2 controller, tap [Next].

Enter a passkey of your choice (for example, 1234) to establish a secure connection. Do not tap [Next] until you complete step 7.
 - ◆ On a Trimble CU controller, tap the --> softkey to make it a Trusted device.

When prompted to authenticate the device, select [Yes].

When the [Enter Pin] dialog appears, enter a PIN of your choice, for example, 1234. Do not tap [OK] until you complete step 7.

7. On the cellular modem, select the appropriate option to accept a pairing request.

For example, on the Sony Ericsson T68i, you need to select [Connect (8) | Bluetooth (4) | Paired Devices (2) | Add Device | Phone accepts (2)].

Note - The controller **must** become a paired/trusted device on the phone.

8. To complete pairing the devices:

- ◆ On the TSC2 controller, tap [Next].

Enter a display name for the device and then tap [Finish].

- ◆ On a Trimble CU controller, tap [OK] on the [Enter Pin] dialog.

The cellular modem prompts you to add the controller as a paired device and allows you to enter the corresponding PIN you selected in step 8.

The controller is now listed as a paired device on the cellular modem, and the cellular modem is added to the list of trusted devices on the controller.

9. Tap [OK] to return to the Trimble Survey Controller software.

Note - If you use the Trimble Survey Controller software to dial a base station directly using a Bluetooth cellular phone, do not run [Bluetooth2Mobile.exe]. If you do, the software cannot connect to the modem; the error message *Connection failed* appears.

To connect to the Internet, you must create a dialing location and start a GPRS connection. For more information see [Connecting to the Internet](#).

To use a cellular modem for real-time surveying, see [Using cellular modems](#).

To configure the Trimble Survey Controller software to connect to a Bluetooth laser rangefinder:

You can connect a TSC2 or a Trimble CU controller to supported Bluetooth laser rangefinders.

1. Switch on the laser rangefinder and the controller.

2. Start the Trimble Survey Controller software and then select *Configuration / Controller / Bluetooth* from the main menu.

3. Tap *Config* and make sure that Bluetooth is switched on:

- ◆ On a TSC2 controller, make sure that the [Turn on Bluetooth] and [Make this device discoverable to other devices] check boxes are selected.

- ◆ On a Trimble CU controller, make sure that the [Enable Bluetooth] check box is selected.

4. Start a scan on the controller

- ◆ On a TSC2 controller, tap the [Devices] tab and tap [New Partnership...].

- ◆ On a Trimble CU controller, tap [Scan].

(Do not use [Stop] - wait for the scan to complete.)

5. The Trimble Survey Controller software searches for other Bluetooth devices within range. Once the scan is complete, highlight the Bluetooth device to connect to:
 - ◆ On a TSC2 controller, tap [Next].

When connecting a controller to a Bosch DLE 150 laser rangefinder, you must enter a passkey. Enter the passkey provided with the Bosch DLE150 and then tap [Next]. When connecting a controller to other supported laser rangefinders, just tap [Next].

Enter a display name for the device and then tap [Finish].

- ◆ On a Trimble CU controller, tap the --> softkey to make it a Trusted device.

When connecting a controller to a Bosch DLE 150 laser rangefinder, you must Authenticate the device. When the authentication request appears, enter the pin provided with the Bosch DLE 150 and then tap [OK]. When connecting a controller to other supported laser rangefinders, authentication is not required.

6. Tap [OK] to return to the Trimble Survey Controller software.
7. In the *Connect to laser* field, select the Bluetooth device to connect to. Then tap *Accept*.

The Trimble Survey Controller software connects to the laser rangefinder when you open the *Measure laser points* screen or when you use the laser to measure distances for field fill in.

Using the Microsoft Windows Mobile Beam program to send files between a TSC2 controller and a Bluetooth Cellular modem

You can use the Beam program on Microsoft Windows Mobile software for Pocket PCs to transfer a file between a TSC2 controller and a Bluetooth cellular modem.

To transfer a file from the TSC2 controller to a Bluetooth cellular modem:

1. Close the Trimble Survey Controller software. Otherwise, the file transfer may fail.
2. On the controller, tap [Start / Settings / Connections / Bluetooth]. Make sure that the [Turn on Bluetooth] and [Make this device discoverable to other devices] check boxes are selected.
3. Tap [Start / Programs / File Explorer] and then browse to find the file to send.
4. Tap and hold on the file and then tap [Beam File].
The controller scans for devices within range.
5. Tap the device that you want to send the file to.
The status changes from [Tap to send] to [Pending].
The receiving device acknowledges the incoming file.
6. Tap [Yes] to accept the file. The file is transferred.
On the controller, the status field displays [Done].

To transfer a file from a Sony Ericsson Z1010 to a TSC2 controller:

1. Use the File manager on the Z1010 to locate the file to send to the controller.
2. Press [More], select [Send] and then select [Via Bluetooth].
The cellular modem scans for devices within range.

3. Select the TSC2 controller that you want to send the file to.
4. If you need to pair and authenticate the devices, follow the prompts on the cellular modem and on the controller, as required.
The devices connect and the file is transferred.
The file is saved to [\\My Documents] on the controller.

Transferring files between controllers

To transfer files between controllers, you can use either the File Transfer application or Microsoft Windows Mobile Beam application. Within the application, and depending on the controllers that you are transferring files between, you can use Bluetooth wireless technology, Infrared (IrDA), a serial cable, or a network cable (TCP/IP).

The application and the connection types that you can use to transfer files between controllers are as follows:

- * = this feature is supported
- = this feature is not supported

From	To	Recommended application	Bluetooth	Infrared	Serial cable	Network
TSC2	TSC2	Beam	*	-	-	-
		File Transfer	*	-	*	-
	TCU	Beam	-	-	-	-
		File Transfer	*	-	*	-
	TSCe	Beam	-	-	-	-
		File Transfer	*	-	*	-
ACU	Beam	-	-	-	-	
	File Transfer	*	-	*	-	
TCU	TSC2	File Transfer	*	-	*	-
	TCU	File Transfer	*	-	*	-
	TSCE	File Transfer	*	-	*	-
	ACU	File Transfer	*	-	*	-
TSCe	TSC2	File Transfer	*	-	*	-
	TCU	File Transfer	*	-	*	-
	TSCe	File Transfer	*	*	*	*
	ACU	File Transfer	*	-	*	*
ACU	TSC2	File Transfer	*	-	*	-
	TCU	File Transfer	*	-	*	-
	TSCe	File Transfer	*	-	*	*
	ACU	File Transfer	*	-	*	*

Using the File Transfer Application to send files between controllers

You can use the File Transfer Application to transfer any type of file between controllers, using Bluetooth wireless technology, Infrared (IrDA), a serial cable, or a network cable (TCP/IP).

See the table [above](#) for details on the connection types supported between different controllers.

To configure the transfer method:

1. Start the Trimble Survey Controller software and then select *Files / Import/Export / File Transfer Application* from the main menu.

Note - You can also open the File Transfer Application from outside the Trimble Survey Controller software:

- ◆ On a TSC2 controller, open the application from [Start / Programs / File Transfer].
 - ◆ On a Trimble CU, ACU, or TSCe controller, open the application from [Start / Programs / Utilities/ File Transfer].
2. Tap [Settings].
 3. To be asked which transfer method to use each time you transfer a file, select [Always ask which transport to use].
 4. To use the same transfer method each time, select [Always connect using:], and use the [Choose] softkey to select your transfer method.
 5. Configure the other options as appropriate.

Before you can transfer files using Bluetooth, you must configure the Bluetooth devices:

1. Enable Bluetooth on both controllers:
 - ◆ On a TSC2 controller, tap [Start / Settings / Connections / Bluetooth]. Make sure that the [Turn on Bluetooth] and [Make this device discoverable to other devices] check boxes are selected.
 - ◆ On a Trimble CU, ACU, or TSCe controller, tap [Start / Settings / Control Panel / Bluetooth Device Properties]. make sure that the [Enable Bluetooth] check box is selected.
2. Start a scan on one controller:
 - ◆ On a TSC2 controller, tap the [Devices] tab and then tap [New Partnership...].
 - ◆ On a Trimble CU, ACU, or TSCe controller, tap [Scan]. (Do not use [Stop] - wait for the scan to complete.)

Do not perform a scan on more than one controller at the same time. A Bluetooth device cannot respond if it is scanning.

4. Once the scan is complete, highlight the Bluetooth device to connect to.
 - ◆ On a TSC2 controller, tap the [Next] softkey. When connecting one controller to another controller, you do not need to enter a passkey. Tap [Next]. Enter a display name for the device and then tap [Finish].
 - ◆ On a Trimble CU, ACU, or TSCe controller, tap the --> softkey to make it a Trusted device. When connecting one controller to another controller, you do not need to Authenticate the device. When the authentication message appears, tap [No].

To transfer files using the File Transfer Application and Bluetooth wireless technology:

Note - You can transfer only one file at a time with the File Transfer Application.

1. Use Bluetooth wireless technology to connect the controllers, as described above.
2. On both controllers, start the Trimble Survey Controller software and then select *Files / Import/Export / File Transfer Application* from the main menu.

Note - You cannot transfer files that are in use by the Trimble Survey Controller software. To make sure that files transfer successfully, close the software.

3. On the controller that is to **receive** the file, select [File / Receive]. If required, select the transport to use.
4. On the controller sending the file, highlight the file and select [File / Send to / File Transfer]. If required select the transport to use.
5. Select [OK].
The file will be transferred.

Using the Microsoft Windows Mobile Beam program to send files between controllers

You can use the Beam program on Microsoft Windows Mobile software for Pocket PCs to transfer any type of file between two TSC2 controllers, or from a TSC2 controller to an office computer using Bluetooth wireless technology.

Note - You can only transfer one file at a time with Beam.

To transfer files using Beam:

1. Enable Bluetooth wireless technology on the controller/s.
 - ◆ On a TSC2 controller, tap [Start / Settings / Connections / Bluetooth].
Make sure that the [Turn on Bluetooth] and [Make this device discoverable to other devices] check boxes are selected.
2. Close the Trimble Survey Controller software. Otherwise, the file transfer may fail.
3. On the controller that is to **send** the file, select [Start / Programs / File Explorer].
Browse to find the file to send.
4. Set up the device that will **receive** the file.
 - ◆ If you are sending to another TSC2 controller, browse to [Start / Settings / Connections / Beam] and make sure that the *Receive all incoming beams* check box is selected.
 - ◆ If you are sending to an office computer, you must initiate the computer to receive a file.
5. On the controller **sending** the file, tap and hold on the file and then tap [Beam File].
6. The controller scans for devices within range. Select the device that you want to send the file to.
7. On the receiving device, accept the file. The file is transferred.

For help with Bluetooth issues, go to [Troubleshooting](#).

You can use Bluetooth wireless technology to establish a connection between a Trimble CU and an office computer, and then you can transfer files using Bluetooth and the Trimble Data Transfer utility or Microsoft ActiveSync. For more information, see [Using Bluetooth to Connect a Trimble CU to an Office Computer](#).

Instruments

Instrument Menu

This menu provides information about the instrument connected to the Trimble Controller, and is used to configure the settings.

Available options depend on the instrument that is connected.

For more information on GPS instrument controls, see the following topics:

[Satellites](#)

[Receiver Files](#)

[Position](#)

[Receiver Status](#)

[GSM Status](#)

[Receiver settings](#)

[Navigate to Point](#)

[Network/Reference Station Status](#)

For more information on conventional instrument controls, see the following topics:

[Electronic Level](#)

[Direct Reflex](#)

[Turn to](#)

[Joystick](#)

[Video](#)

[Tracklight](#)

[Autolock and Search Controls](#)

[Instrument Settings](#)

[Radio Settings](#)

[Adjust](#)

[Trimble Survey Controller Basic](#)

[Trimble Functions](#)

[GDM Data Output](#)

Satellites

To see information about the satellites currently being tracked by the receiver, tap the satellite icon on the status bar or select *Instrument / Satellites* from the main menu.

A satellite is identified by the space vehicle (SV) number.

- GPS satellite numbers are prefixed with a "G".
- GLONASS satellite numbers are prefixed with an "R".

The satellite positions can be represented graphically with the sky plot or textually in a list.

Sky Plot

To see a sky plot, tap *Plot*.

- Tap *Sun* to see the plot oriented towards the sun.
- Tap *North* to see the plot oriented towards north.
- The outside circle represents the horizon or 0° elevation.
- The inner, solid green, circle represents the elevation mask setting.
- The SV numbers on the diagram are placed in the position of that particular satellite.
- Satellites that are tracked but not used in the position solution appear in blue.
- The zenith (90° elevation) is the center of the circle.

Tap the SV number to view more information about that specific satellite.

Satellite List

To see the list of satellites, tap *List*.

- In the list of satellites, each horizontal line of data relates to one satellite.
- Azimuth (*Az*) and elevation (*Elev*) define a satellite's position in the sky.
- The arrow displayed next to the elevation indicates whether the elevation is increasing or decreasing.
- The signal-to-noise ratios (SNR) indicate the strength of the respective satellite signals. The greater the number, the better the signal.
- If L1 or L2 are not being tracked, then a dashed line (----) appears in the appropriate column.
- The check mark on the left of the screen indicates whether that satellite is in the current solution, as shown in the following table.

Situation	What a check mark indicates
No survey is running	Satellite is being used in the current position solution
RTK survey is active	Satellite is common to the base and rover receivers
Postprocessed survey is running	Satellite for which one or more epochs of data have been collected

- To see more information about a particular satellite, tap the appropriate line.

You can also select the following options:

- To stop the receiver tracking a satellite, tap the satellite to display the satellite information and then tap *Disable*.

Note - If you disable a satellite, it remains disabled until you enable it again. Even when the receiver is switched off, it stores that a satellite is disabled.

- To change the **elevation** mask and the **PDOP** mask for the current survey, tap *Options*.
- In a real-time survey, tap *Base* to see which satellites are being tracked by the base receiver. No values appear in the *Az* and *Elev* columns, as this information is not included in the correction message broadcast by the base.
- In a postprocessed survey, the *L1* softkey appears in the *Satellites* dialog. Tap *L1* to display a list of cycles tracked on the L1 frequency for each satellite.

The value in the *CntL1* column is the number of cycles on the L1 frequency that have been tracked continuously for that satellite. The value in the *TotL1* column is the total number of cycles that have been tracked for that satellite since the start of the survey.

- With a dual-frequency receiver, the *L2* softkey appears in the *Satellites* dialog. Tap *L2* to display a list of cycles tracked on the L2 frequency for each satellite.

The *SNR* softkey appears. Tap *SNR* to return to the original screen and view information about the signal-to-noise ratio for each satellite.

Enabling and Disabling WAAS and EGNOS satellites

When you start a WAAS or EGNOS survey with Trimble Survey Controller, the appropriate satellites are enabled in the receiver so that they can be tracked. Four WAAS satellites are enabled (numbers 122, 134, 135 and 138) and two EGNOS satellites are enabled (numbers 120 and 131).

To use an alternative WAAS or EGNOS satellite, disable the satellite(s) that you do not want to use, and enable the satellite that you want the receiver to track. To do this:

1. Start the survey with the WAAS/EGNOS enabled style.
2. Tap the satellite icon.
3. Tap *Info* and then enter the number of the satellite that you want to enable or disable.
4. Tap *Enable* or *Disable*.

The WAAS/EGNOS satellites remains enabled or disabled until the next time that you start a new survey with Trimble Survey Controller.

Receiver Files

If the controller is connected to a receiver that supports this function, you can transfer files to and from the Trimble controller to the survey data card on the receiver.

The *Import from receiver* option is available when a Trimble R8, R7, R6, 5700, 4800, or 4700 receiver is in use. Use it to delete files in the connected receiver, or to copy files from the connected receiver to the controller.

The *Export to receiver* option is available when a Trimble R7 or 5700 receiver is in use and has a compact flash card inserted. Use it to copy files from the controller to the connected receiver.

You can transfer files only to and from the **current project folder** on the controller. To transfer files to or from **another** project folder, open a job in the required project folder (which thereby changes that one to the **current** project folder) and then transfer the files. Alternatively, use Windows Explorer to copy the files to another folder.

You can transfer the following types of files: R00, T01, DAT, JOB, STY, CSV, TXT, DXF, TIN, CDG, and FAL.

To transfer files from the receiver to the controller:

1. From the main menu, select *Instrument / Receiver files / Import from receiver*.
The list that appears shows all files stored in the receiver.
2. Tap the file(s) to transfer. A check mark appears next to the selected files.

Note - To see more information about a file, highlight the file name and tap *Info*. To delete a file, highlight the file name and tap *Delete*.

3. Tap *Import*. The *Copy file to Trimble Controller* screen appears.
4. Tap *Start*.

To transfer files from the controller to the receiver:

1. From the main menu, select *Instrument / Receiver files / Export to receiver*.
The list that appears shows all files in the current project folder on the controller.
2. Tap the file(s) to transfer. A check mark appears next to the selected files.
2. Tap *Export*.
3. Tap *Start*.

Position

This function displays the current position of the base or rover GPS antenna.

A projection and datum transformation must be defined to view grid coordinates.

The precision of this position depends on which survey method is selected. Precisions are:

- +/- 10 m (no current survey)
- +/- 10 m (postprocessed survey)
- +/- 0.01 m (RTK survey)

To see the current position, from the main menu, select *Instrument / Position*.

If the antenna height is defined, the software calculates the position of the roving antenna. To view the position of the base antenna as well, tap *Base*.

Tap *Options* to find out whether the position is shown as WGS-84, local, or grid.

Receiver Status

To view the power and memory status of the connected GPS receiver, the GPS time, and the GPS week, select *Instrument / Receiver status* from the main menu.

GSM Status

To view the GSM signal strength and available network operators when using the R8 or R6 Trimble Internal GSM module, select *Instrument / GSM Status* from the Instrument menu.

Receiver Settings

To view the configuration of the connected GPS receiver, select *Instrument settings* from the main menu.

Alternatively, tap the receiver icon on the status bar.

Navigate to Point

You can navigate to a point without using a radio link, or without a survey running. If there is no radio link, all positions are autonomous. If radio corrections are received but the receiver is not initialized, all positions are Float solutions. When you start the *Navigate to point* function, it uses the settings in the last GPS Survey Style that you used.

If you are using a GPS receiver that can track WAAS/EGNOS signals, when the radio link is down you can use WAAS/EGNOS positions instead of autonomous positions. To use WAAS/EGNOS positions, set the

Satellite differential field in the survey style to WAAS or EGNOS.

To navigate to a point:

1. From the map, select the point you want to navigate to.
2. Tap and hold on the map and then select *Navigate to point* from the shortcut menu. Alternatively, select *Instrument / Navigate to point* from the main menu.
3. If you want to display cross-track information, set the *Navigate* field to *From fixed point* or *From start position*.
4. Fill in the other fields as required and then tap *Start*. The graphical display screen appears.
5. Use the arrow to navigate to the point, which is shown as a cross. When you are close to the point, the arrow disappears and a bull's-eye symbol appears.
6. When you are on the point, the bull's-eye symbol covers the cross.
7. Mark the point if required.

Network / Reference Station Status

When you perform a real-time survey and the reference station or network server that you receive base station data from supports status messaging, the *Network/Reference Station Status* menu option appears. The screen for this menu option shows the reported status of the reference station server, the options the reference station supports (such as *RTK on Demand*), and also enables you to configure notification and storage of the status messages in the current job.

If you select the *Popup new Reference Station* messages check box, messages from the reference station or network server pop up on the screen.

If you select the *Store Reference Station* messages check box, messages from the reference station or network server are stored in the current job database.

Station Setup Details

To view the instrument type and current station setup information when the controller is connected to a conventional instrument, select *Instrument / Station setup* details from the main menu.

Alternatively, if you are using a mechanical instrument (not a servo or robotic instrument), tap the Instrument icon on the status bar.

Laser pointer

In a [Direct Reflex](#) survey, the laser pointer eliminates the need to look through the telescope when measuring DR points.

Note - When using a 5600 DR200+ instrument, the laser pointer is not coaxial with the telescope.

To turn on the laser:



1. To open the *Trimble Functions* screen, tap the Instrument icon in the status bar, or tap the Trimble key (if available) on the controller.
2. Click the Laser pointer button.

Note - If DR is not yet enabled, turning on the laser pointer enables it. If you turn off the laser pointer, the instrument remains in DR mode. However, if you turn off DR mode, the laser is automatically turned off.

To automatically measure to the laser pointer with a non-coaxial 5600 DR200+ or DR300+, configure the Laser alignment setting in *Instrument / Direct reflex*. For more information, see the section on [Laser alignment](#) in Direct Reflex.

Electronic Level

The electronic level is available when connected to Trimble VX/S Series, 5600, and 3600 instruments.

To level a Trimble VX/S Series instrument electronically from startup:

1. Plumb the instrument.
2. Use the tripod legs and the tribrach bubble to roughly level the instrument.
3. Establish a connection between the controller and the instrument. The Electronic level screen appears as part of the connection process.

If the instrument is not level enough, you will get a tilt error. Roughly level the instrument with the tribrach circular bubble to bring the electronic level into range.

4. Turn the footscrews to center the bubbles for the sighting and trunnion axis.
5. To complete the leveling process, tap *Accept*.

To level a Trimble 5600 instrument electronically from startup:

1. Plumb the instrument.
2. Use the tripod legs and the tribrach bubble to roughly level the instrument.
3. Establish a connection between the controller and the instrument. The Electronic level screen appears as part of the connection process.
4. Turn the footscrews to center the bubbles for the sighting and trunnion axis.
5. To complete the leveling process, tap *Accept*.

The instrument initializes the compensator (unless the *Disable compensator* check box is selected).

When Trimble Survey Controller connects to a Trimble 5600 instrument, the compensator is not reinitialized if it was initialized within the last 2 hours and if the instrument level has not changed by more than 30 seconds.

To level an instrument electronically during a survey:

1. From the main menu, select *Instrument / Electronic level*.
2. Turn the footscrews to center the bubbles for the sighting and trunnion axis.

For the Trimble 3600 instrument only, the laser plummet is also activated while the Electronic level screen is open.

Warning - If accuracy is important, do not disable the compensator. If you do disable the compensator, horizontal and vertical angles in the instrument are not corrected for mis-levelment errors.

Direct Reflex

When Trimble Survey Controller is connected to an instrument with Direct Reflex (DR), select *Instrument / Direct Reflex* to configure the DR settings.

Tip- For fast access to configure the DR settings, tap the instrument icon in the status bar or press the Trimble key, and tap and hold on the DR icon.

The following settings are available if supported by the instrument:

- To enable or disable direct reflex measurement, select *DR*.
- To enable or disable the laser, select *Laser*.
- To take a measurement to where the laser is pointing, set the Laser alignment to *Horizontal* or *Vertical* (depending on the surface you are measuring to). For more information see, [Laser alignment](#).
- To accept measurements at a lower accuracy (that is, below the normal instrument specification), enable weak signal.
- To define the acceptable accuracy of a DR measurement, enter a standard deviation value. When measuring to diffuse targets the standard deviation is displayed on the status line until the standard deviation satisfies the defined value. Once the standard deviation is satisfied, the DR measurement is accepted. To accept the DR measurement before the standard deviation is satisfied, tap *Enter* while the standard deviation is displayed on the status line.
- To restrict the DR measurement range, enter a minimum and maximum distance. Use this to avoid a result from a distant or intermittent object.

When using DR with a Trimble VX/S Series, 5600, or 3600 instrument, Target DR is dedicated for DR use. You must configure the prism constant and target height appropriately.

When you turn on DR, Trimble Survey Controller automatically switches to Target DR.

When you turn off DR, the software returns to the last used non-DR target. If the last used target has been deleted, the software uses Target 1.

Alternatively, select *Target DR* to enable DR. Select *Target 1* to disable DR and return the instrument to its previous state.

Trimble Survey Controller supports up to six preconfigured targets, but only one DR target. For more information see, [Target details](#).

Laser alignment

The laser pointer on a Trimble 5600 DR 200+ or DR 300+ instrument is not coaxial with the EDM. As a

result, the location where the DR measurement is observed will not correspond to the location of the laser dot. To configure Trimble Survey Controller to measure to the laser dot, do the following:

1. Enable the laser pointer.
2. Select a laser alignment:
 - None – DR measurement is observed below the laser dot.
 - Horizontal – DR measurement is observed at the location of the laser dot provided that the measurement is on a horizontal surface.
 - Vertical – DR measurement is observed at the location of the laser dot provided that the measurement is on a vertical surface.

The instrument will turn to the location of the laser dot and perform the measurement. Once the observation is completed, the instrument will turn the laser dot back to the observed point.

For more information, see:

Scanning

Surface Scan

Remote Object

Turn to

If using a servo or [robotic instrument](#), you can use the *Turn to* options to control how the instrument moves.

To do this:

1. From the main menu, select *Instrument / Turn to*. Alternatively, tap the Instrument icon on the status bar and then click the **Turn to** button on the Trimble Functions screen.
2. Select an instrument control method to turn the instrument to a specified angle or point:
 - ◆ to a horizontal or vertical angle only, enter the angle in the *Turn to* field.
 - ◆ to a horizontal and vertical angle, enter the horizontal angle in the *Turn to HA* field, and the vertical angle in the *Turn to VA* field.
 - ◆ to a specified point, enter a point name in the *Point name* field.
 - ◆ by distance, enter the distance from your current position to the point where the instrument lost lock.
3. Tap *Turn*. The instrument turns to the angle(s) or point you entered.

To turn the instrument horizontally 90° to the right or left, or 180° use the appropriate softkey at the bottom of the screen.

To make the instrument locate and lock on to the target, tap *Search*.

The message "Searching..." appears and the instrument starts searching for the target.

For information on other methods, see:

- [Joystick](#)
- [Robotic instrument](#)
- [Map of current job](#)

Joystick









If you are operating a robotic instrument at the remote end (target), use the *Joystick* softkey to turn the instrument towards the target when lock has been lost.

To turn the instrument towards the target:





1. From the main menu, select *Instrument / Joystick*. Alternatively, tap the Instrument icon on the status bar and then tap *Joystick* button on the *Trimble Functions* screen.
2. Tap an arrow on the screen or press the up, down, left, or right arrow keys to turn the instrument. The instrument turns in the direction indicated by the solid/filled arrow.

Note - When the instrument is on Face 2, the up and down arrows are reversed. For example, if you press down the instrument turns upwards. If you press up it turns downwards.

3. When using a Trimble VX/S Series, turn the instrument as shown in the following table.

Tap and hold this arrow	to turn the instrument
 or 	horizontally (left or right)
 or 	vertically (up or down)
 ,  ,  , or 	horizontally and vertically

Notes

- ◆ To stop the instrument turning, release the arrow.
- ◆ To change the direction tap the change direction button ( → ,  → ).
 - ◇ When the instrument icon is to the left of the prism icon, the instrument turns as if you are standing behind the instrument.
 - ◇ When the instrument icon is to the right of the prism icon, the instrument turns as if you are standing at the pole.
- ◆ To increase or decrease the turning speed, tap the left (decrease) or right (increase) speed arrows.

4. When using a Trimble 5600, turn the instrument as shown in the following table.



Tap this arrow	to turn the instrument
first left or right	horizontally 12 ⁰
second left or right	horizontally 120 ⁰
first up or down	vertically 1 ⁰
second up or down	vertically 5 ⁰

Tap *Esc* or another arrow to stop the instrument from turning. The directional arrow becomes hollow. The instrument now points towards the target.

- When using a Leica TPS1100 series instrument, select the same direction to increase the instrument turning speed. The second directional arrow becomes solid. Select the same arrow again to decrease the speed.

Tap *Esc* or another arrow to stop the instrument from turning. The directional arrow becomes hollow. The instrument now points towards the target.

To make the instrument locate and lock on to the target, tap *Search*. The message "Searching..." appears and the instrument starts searching for the target.

When [GPS Search](#) is ready, a  softkey is available. To perform a GPS-aided search, tap .

The search results appear in the status line as messages:

- Target Locked - indicates that the target has been located and tracking locked.
- No Target - indicates that the target was not located.

For information on other methods, see:

- [Turn to](#)
- [Robotic instrument](#)
- [Map of current job](#)

Video

The Trimble VX instrument is equipped with a built-in camera. This enables you to:

- See the telescope's field of view on the controller screen, eliminating the need to look through the telescope
- Control the instrument movement by *Tap-and-move*
- Capture images
- View features from multiple sources in 3D, overlaid on the video screen

The camera is not coaxial with the telescope. Therefore:

- The Trimble Survey Controller software corrects for this offset when a distance is received from the

instrument.

- When there is no distance returned from the instrument (for example, in Standard mode, or in Tracking mode with no target), there could be a vertical offset of up to 38 mm between the crosshair shown on the video screen and the crosshair viewed through the telescope. This offset is most noticeable at close range. The Trimble Survey Controller software uses the last measured distance to calculate the offset correction. If no measurement has been taken, a distance of infinity is assumed.

When connected to a Trimble VX instrument, do one of the following to access the video screen:

- From the main menu, tap *Instrument / Video*.
- Tap the Trimble functions icon and then tap *Video* in the *Trimble Functions* screen.

Notes

- The video option is available only when connected to a Trimble VX instrument.
- Video is not available when the Trimble Survey Controller software is connected through a serial cable connection.
- Video is not available when the Trimble Survey Controller software is connected through Bluetooth wireless technology.
- Video is not available when the scanning form is open. If you open the scanning form while the video form is open, the video form automatically closes.
- Because of the resolution of the video image, there may be a difference of up to one pixel between the crosshair in the video image and the crosshair viewed through the telescope. This difference can be seen with all overlaid data.
- Snapshots taken between $3^{\circ}36'$ (4 gon) and the zenith will not be directly matched to the point data in the RealWorks Survey software.

For more details, see:

- [Data Overlay](#)
- [Tap-and-Move](#)
- [Capturing images](#)
- [Video softkeys](#)
- [White balance](#)

Data Overlay

Features from the job are overlaid onto the video image to show a graphical representation of features in 3D. Overlaid features can come from multiple sources:

- points, lines, and arcs from the current job database
- points from linked jobs, linked CSV files, and from [map files](#) (for example, DXF and SHP files)
- coded features from feature and attribute libraries

Notes

- Features can be displayed only if they are defined in 3D. This requires that a full 3D station setup has been completed, with a station elevation and instrument height defined.

- Features displayed in the video screen cannot be selected.
- Only grid coordinates are displayed. If you have not defined a projection, only points stored as grid coordinates appear.
- If there is a point with the same name as another point in the database, the point with the higher search class is displayed. For more information about how the Trimble Survey Controller software uses search classes, see [Database search rules](#).

Tap-and-Move

Tap-and-move allows you to control the instrument. Tap in the video screen to turn the instrument to that location.

Notes

- When you are working in the video screen, the up, down, left, and right arrow keys are in [Joystick](#) mode and can be used to turn the instrument.
- *Tap-and-move* is affected by the offset from the non-coaxial camera.

Capturing images

You can capture the image displayed in the video frame of the scanning window.

- Captured images are stored as JPEG files in the current [project folder](#).
- Captured images can be viewed in Review current job.
- Image options are controlled by [photo properties](#).

Images can be automatically captured when a measurement from the video window is taken. Review current job overlays the measured point onto the associated video image, along with information about the target height. This data is not stored in the JPEG file.

Tip - Use the [Panorama](#) function to automatically capture multiple images for a defined scan frame.

To ensure that images can be correctly matched to point data in the RealWorks Survey software, always complete a station setup before you capture any images. Otherwise, there is no orientation information stored with the image.

Note - If tracking is turned on and the instrument is locked to a prism, do not move the prism while the image is being captured. Otherwise, you could capture the wrong image, and the wrong orientation information will be stored with that image.

To transfer JPEG files from the Trimble CU in the docking station to the office computer, use the USB-to-Hirose cable.





You cannot use the DB9-to-Hirose serial cable to transfer JPEG files.

Video softkeys

Use the video softkeys to:

- zoom in and out
- capture images
- view and control the brightness and contrast
- view and control photo properties and snap shot options
- change the display options

The softkey functions are as follows.

Softkey	Function
+	Zoom in. There are four levels of zoom available in the video window.
-	Zoom out. There are four levels of zoom available in the video window.
	Captures an extra large (XL) image (2048x1536). XL is available only when zoomed to extents 1:1.
	Captures a large (L) image (1024x768). L is available only when zoomed out to extents 1:1 and 2:1.
	Captures a medium (M) image (512x384). M is not available when zoomed in to 4:1.
	Captures a small (S) image (256x192). S is available regardless of the zoom level.
	Controls the brightness of the video image on the controller screen and consequent captured images.
	Controls the contrast of the video image on the controller screen and consequent captured images.
	Controls the level of white balance in the video image on the controller screen and consequent captured images.

White balance

There are three settings of white balance available. Select the white balance setting most suitable to the lighting conditions at your setup:

White Balance setting	Use...
Daylight	outdoors, in bright settings
Incandescent	under artificial light
Fluorescent	under fluorescent lighting

Click the up arrow to access more softkey functions. The additional functions are as follows.

	Set the file name. File names are automatically incremented from the start file name.
	Set the image size. The image captured is always the same as the video display on screen. Not all image sizes are available at all zoom levels.
	Set the compression of the image. The higher the quality of the image, the larger the file size of the captured image.
<i>Filter</i>	Shows a legend for the feature symbols and lets you choose which features are displayed.
<i>Options</i>	<i>Display labels</i> controls how name or code labels appear next to points in the map.
	<i>Display elevations</i> controls the option to display elevations in the video screen.
	Enable <i>Auto measure</i> to automatically start a measurement when you press the measure key.
	Enable <i>Snapshot on measure</i> to automatically capture a snapshot after a measurement is taken from the video screen.

Enable *Autostore snapshot* to automatically store captured images.

Tracklight

When connected to a Trimble S Series instrument, operate the Tracklight as follows.

To set the speed of the guide-light:

1. From the main menu, select *Instrument / Tracklight*.
2. Select the *Enable tracklight* check box.
3. From the drop down list in the *Speed* field, select *Slow*, *Fast*, or *Auto*.

Tip - When *Auto* is selected, the Tracklight flashes fast when the target is locked and slow if there is no target.

To switch on the tracklight or switch it off:

1. Tap the Trimble functions icon.
2. Tap *Tracklight* in the *Trimble Functions* screen.

Note - The Tracklight is not available when connected to a Trimble VX instrument.

When connected to a Trimble 3600 or 5600 instrument, operate the Tracklight as follows.

To set the intensity of the guide-light:

1. From the main menu, select *Instrument / Tracklight*.
2. Select the *Enable tracklight* check box.
3. From the drop down list in the *Intensity* field, select *Normal* or *High*.

To switch on the tracklight or switch it off:

1. Tap the Trimble functions icon.
2. Tap *Tracklight* in the *Trimble Functions* screen.

Tip - For fast access to configure the Tracklight, tap the instrument icon in the status bar or press the Trimble key, and tap and hold on the Tracklight icon.

Note - When *EDM power save* is enabled on a Trimble 5600 DR Standard instrument, the Tracklight is not available.

Autolock

If Autolock is available on the instrument, use it to lock on to and track a remote target.

To enable/disable Autolock, do one of the following:

- To open the *Trimble Functions* screen, tap the instrument icon on the status bar or tap the Trimble key (if available) on the controller.
- Select the Autolock icon.
- From the main menu, select *Instrument / Autolock and Search controls*.

A search is automatically performed if a measurement is initiated when Autolock is enabled but the instrument is not locked to the target.

When [GPS Search](#) is ready, a GPS-aided search is performed instead of a standard search. To perform a standard search, pause GPS Search, or select *Search* available from the [Joystick](#) screen.

Tip- For fast access to configure the Autolock and search settings, tap the instrument icon in the status bar or press the Trimble key, and tap and hold on the Search icon.

Note - Do not use Autolock during the collimation or Trunnion axis tilt tests. For more information, see [Instrument Adjustment](#).

This provides additional Autolock controls:

Snap to target

This function was previously called *Advanced lock*.

Snap to target automatically locks on to a remote target if one is detected. If you do not want to automatically lock onto a target, set the Autolock method to *Snap disabled*.

Note - *Snap to Target* does not check the Target ID.

Autosearch

Select *Autosearch* to automatically perform a horizontal search when lock is lost to a remote target.

Predictive Tracking Time

This feature enables you to pass behind a temporary obstruction and have the instrument continue to turn, based upon the target's horizontal trajectory, when lock to the prism is lost.

If the trajectory is consistent and the prism re-appears from behind the obstruction within the defined time interval, the instrument will be aimed directly at the prism and lock is automatically regained.

After the specified time interval, the Trimble Survey Controller software reports that the target is lost and then takes corrective actions based on the current settings.

The instrument turns to where the target was last seen and then acts as follows:

--	--	--

If Autosearch is ...	and Snap to target is ENABLED, the instrument ...	and Snap to target is DISABLED, the instrument ...
On	Locks on to any target in the field of view. If there is no target, a search starts based on your search window settings.	Ignores any visible targets and starts a search based on your search window settings
Off	Locks on to any target in the field of view or waits until a target comes into the field of view and then locks onto it.	Ignores any targets in the field of view and does not start any search until you prompt it to do so.

Note - The Trimble Survey Controller software defaults are *Snap to target* ENABLED and *Autosearch* OFF.

You can configure the Predictive tracking time as follows:

- For standard robotic usage, Trimble recommends the default setting (1s).

This enables you to pass behind anything small blocking the line of sight between the instrument and the target (for example, trees, electrical posts, or vehicles) and then automatically regain lock.

- In environments with a number of reflective objects, you could set the predictive tracking time to 0s. For optimal performance, use this setting with Snap to target DISABLED.

With these settings, you are immediately informed if the line of sight to the correct target is obstructed. You can then ensure that you regain lock to the correct target.

- In environments where your target may be blocked for a few seconds at a time, you can use settings of 2s or 3s.

This enables you to pass behind larger objects blocking the line of sight between the instrument and the target (for example, small buildings) and then automatically regain lock.

If the instrument fails to regain lock onto the moving target, it returns to the location where it first lost lock and the predictive tracking began.

To change the Predictive tracking time:

1. Do one of the following:
 - ◆ From the main menu, select *Instrument / Autolock and Search controls*.
 - ◆ From the *Trimble functions* form, tap and hold briefly on the **Autolock** or **Search** icon. When you release, the *Autolock and Search Controls* dialog appears.
2. Select the required time from the Predictive tracking time list.

Tiltable RMT (Trimble 5600 only)

Enable *Tiltable RMT* when you use a remote target tilted towards the instrument. Disable *Tiltable RMT* when you use a fixed vertical target. When disabled, the vertical angle measurement will be corrected for the small offset distance between the RMT and the prism center.

Autocentered Search Window and Search Window Size

When performing a search with the Autocentered search window selected, Trimble Survey Controller uses the current horizontal and vertical angle of the instrument to set the center of the search window, and the horizontal and vertical range to calculate the extents of the window. These extents are sent to the instrument each time it performs a search.

If you do not select the Autocentered search window, the search extents are not reset in the instrument.

To configure the top left and bottom right extents of the search window, point and measure with the instrument before starting the robotic survey. For more information, see [Prepare for a robotic survey](#).

Target tracking with the Trimble VX/S Series

If you use a Trimble VX/S Series instrument with search capabilities and a Trimble VX/S Series 360° prism or a Trimble MultiTrack target, you can configure the software to use an Active Target ID.

Note - If you use a Trimble VX/S Series instrument with the Trimble MultiTrack target, you must upgrade the instrument to firmware version R7.0.35 or later. The Trimble VX/S Series firmware is available on www.trimble.com.

- When using the Trimble MultiTrack target, the **Tracking mode** can be set to *Passive* or *Active*. When the tracking mode is set to *Active*, you can configure the Target ID.
- When using the Trimble VX/S Series 360° prism, the **Target ID** can be set to *Off*, *Search*, *Search and measure*, or *Always*. When the tracking mode is set to *Search*, *Search and measure*, or *Always*, you can configure the Target ID.

From the following, select the target ID checking method that best suits the equipment you have and the environment that you are working in:

- [Active](#) - the instrument is always locked to the active target.
- [Search](#) - check the ID when a search is initiated.
- [Search and measure](#) - check the ID when a search is initiated, and when a measurement is initiated.
- [Always](#) - the ID is constantly being checked by the instrument.

Tracking mode - Active

- If you operate in a highly reflective environment, or on a site with many prisms, set the *Tracking mode* to *Active* to ensure that you maintain constant lock to the correct target.

Check the target ID - Search

- If you operate in an environment with few reflective surfaces, but you want to ensure that if you do a search you will lock to the correct target, set *Check target ID* to *Search*.
- When the *Check target ID* is set to *Search*, the Target ID is checked after a search is made to ensure that you are locked onto the correct target. If not, the Trimble Survey Controller software warns you and you can perform a new search for the correct target ID.

- If you enable *Snap to target* and the instrument automatically detects the target, the instrument does not perform a search or check the Target ID.
- The target ID must be carefully aimed towards the instrument when performing a search.

Check the target ID - Search and measure

- If you operate in an environment with few reflective surfaces, but you want additional assurance if you do a search or when you measure that you will lock to the correct target, set *Check target ID* to *Search and measure*.
- When the *Check target ID* is set to Search and measure, the Target is checked again before a measurement is made to ensure that the instrument is still locked onto the correct target. If not, the Trimble Survey Controller software warns you and you can then perform a new search for the correct target ID.
- The target ID must be carefully aimed towards the instrument when taking a measurement.

Check the target ID - Always

- If you operate in a highly reflective environment, or on a site with many prisms, set *Check target ID* to *Always* to ensure that you maintain constant lock to the correct target.
- When the *Check target ID* is set to Always, the Target ID is used to actively maintain horizontal lock. The prism is used to maintain the vertical lock.
- The Target ID has two "on" modes; on for 60 seconds, and on continuously. When *Check target ID* is set to Always, you must set the Target ID on the pole to "on continuously".
- The target ID must be carefully aimed towards the instrument at all times.

For more information on how to configure the target ID in the Trimble Survey Controller software, see [Target details](#).

For more information on how to configure the target ID on the Trimble pole, refer to the documentation for your instrument.

Note - *Target ID* can be used for rounds observations. For the Trimble MultiTrack target, set *Tracking mode* to *Active*. For the Trimble 360° prism, set the *Check target ID* to *Search and measure*.

Also, make sure that each target in the rounds list can have a different target ID. These settings are retained for each individual target until the rounds observations are completed.

Trimble MultiTrack Target

The Trimble MultiTrack target, together with the Trimble S Series or the Trimble VX Spatial Station, combines the advantages of both passive and active target tracking and the flexibility to instantly choose which method best fits the current task.

To obtain the most accurate measurements with the MultiTrack target ensure that:

- Line of site to the target is maintained during a measurement. When using a Trimble receiver in an integrated survey, ensure that the radio antenna from the receiver does not obstruct the target.
- Ensure that the correct prism type and mode is selected in the target form. This will ensure that the appropriate correction values are applied to the slope distance and vertical angle for geocentric offset

and prism constant.

- The MultiTrack target should be used within the vertical angle tolerances shown in the following table:

Tracking mode	Vertical range
Active	+/- 15° from horizontal
Passive	+/- 30° from horizontal

Using the MultiTrack target outside these tolerances may degrade the accuracy of the measurement.

Leica Search method

If you operate a Leica TPS1100 or TPS1200 instrument that supports *Power search*, you can configure the search method to use for performing a search.

The search methods available are:

- Spiral
- Power search

Use the method that best suits the environment you work in. For more information, refer to the instrument manufacturer's documentation.

Leica ATR mode

If you operate a Leica TPS1200 instrument that supports Low visibility and S-Range ATR modes, you can configure the ATR method used.

The available ATR modes are:

- Normal
- Low visibility on
- Low visibility always on
- S-Range on
- S-Range always on

Use the method that best suits the environment you work in. For more information, refer to the instrument manufacturer's documentation.

GPS Search

During a robotic survey, if the instrument loses lock to the target, you can use a GPS receiver to help point the instrument.

You can enable GPS Search through any of the following:

- a Trimble survey grade GPS receiver
- a Trimble GPS card
- any GPS receiver capable of outputting NMEA (GGA) through a serial or Bluetooth port to the controller:
 - ◆ The receiver must be able to output GGA messages through the NMEA protocol at 1 Hz.
 - ◆ For information on how to manually configure and connect to the receiver, refer to the receiver documentation.

Note - GPS Search is available only when the Trimble Survey Controller software is running on a Trimble CU or TSC2 controller.

To enable GPS Search using a Trimble GPS CompactFlash card:

Note - A Trimble GPS card can be used only in a TSC2 controller.

1. Make sure that the Trimble Survey Controller software is turned off and then insert the Trimble GPS card into the port on the TSC2 controller.
2. Start the Trimble Survey Controller software and then establish a robotic connection between the TSC2 controller and a Trimble VX/S Series or Trimble 5600 total station.
3. From the main menu, select *Instrument / Autolock and Search controls*.
4. Select the *GPS Search On* check box.
5. Set the *3D* check box as required.
 - ◆ If *3D* is enabled, a 3D GPS Search position is computed, and the instrument can turn to the point both horizontally and vertically.
 - ◆ If *3D* is disabled, the instrument can only turn horizontally to the GPS Search position.
 - ◆ If WAAS or EGNOS are available, you can enable *3D* because the GPS heights from a GPS CompactFlash card should be accurate enough to turn the instrument's vertical angle.
 - ◆ If WAAS or EGNOS are **not** available, Trimble recommends that you disable *3D* to prevent incorrect GPS heights from a GPS CompactFlash card causing inaccurate turning of the vertical angle. It may be preferable to turn horizontally only.
6. Set the *Receiver type* to *Trimble GPS card*.

GPS Search is now configured.

To enable GPS Search using a Trimble Survey Grade GPS Receiver:

1. Start the Trimble Survey Controller software and then establish a robotic connection between the Trimble CU or TSC2 controller and a Trimble VX/S Series or Trimble 5600 total station.
2. From the main menu, select *Instrument / Autolock and Search controls*.
3. Select the *GPS Search On* check box.
4. Set the *3D* check box as required.
 - ◆ If *3D* is enabled, a 3D GPS Search position is computed, and the instrument can turn to the point both horizontally and vertically.
 - ◆ If *3D* is disabled, the instrument can only turn horizontally to the GPS Search position.

- ◆ If the GPS receiver is initialized in an RTK survey, or if WAAS or EGNOS are available, you can enable *3D* because the GPS heights from a GPS CompactFlash card should be accurate enough to turn the instrument's vertical angle.
 - ◆ If the GPS receiver is producing autonomous positions, or if WAAS or EGNOS are **not** available, Trimble recommends that you disable *3D* to prevent incorrect GPS heights from a GPS CompactFlash card causing inaccurate turning of the vertical angle. It may be preferable to turn horizontally only.
5. Set the *Receiver type* to *Trimble*.

When connecting the controller to the receiver through Bluetooth wireless technology, you must enable Bluetooth communications on the controller, scan for the Bluetooth device and then set the Bluetooth device in the *Connect to GPS receiver / VX/S Series* field at *Configuration/Controller/Bluetooth*.

If you use a cable to connect the Trimble CU to a GPS receiver, connect the USB-to-serial cable to the Trimble CU robotic holder **before** you start the Trimble Survey Controller software. Otherwise, the COM port is not available.

GPS Search is now configured.

Note - When using a Trimble survey grade GPS receiver for GPS Search, you must establish a connection to the GPS receiver before you start the conventional survey, or, you must start an Integrated Survey. If you start a conventional survey before you connect to the GPS receiver, then a connection to the GPS receiver can only be established by starting a IS/GPS survey.

Resolving the relationship between GPS positions and local positions

Once a station setup is complete, the Trimble Survey Controller software uses the NMEA positions from the GPS receiver and the angles tracked by the robotic instrument to determine the relationship between the two positioning systems. GPS Search computes the relationship independently of the job's coordinate system settings.

Make sure that the GPS receiver has a clear view of the sky and then, with the instrument locked to the prism, move the rod around the instrument until the relationship between the GPS positions and local positions is resolved.

To determine the relationship between the GPS positions and the local positions, GPS Search requires a minimum of five positions at least five meters apart. If the geometry and GPS position accuracy is poor, you need more than five positions to resolve the relationship.

When GPS Search is ready, the message *GPS Search ready* appears in the status line, and the target icon displays a satellite icon above the prism .

Note - If you perform a calibration or change the coordinate system settings, the existing relationship between the GPS positions and local positions is lost and must be recomputed.

Using GPS Search

GPS Search is used automatically when you perform a search for the target. If GPS Search is ready, the instrument turns to the GPS Search position. With a good GPS position, for example from a Trimble R8 receiver with an RTK fixed solution, and when snap is enabled, the instrument should snap to the target immediately. If the instrument does not snap immediately, it performs a search before locking to the target.



A satellite icon appears in the map when GPS Search is ready.

Make sure that there is nothing selected in the map and then tap and hold on the GPS icon. From the menu that appears, select *Turn to* to manually turn horizontally to the GPS Search position.

Tap *Search* in the *Joystick* screen to perform a normal search even when GPS Search is ready. Use this when you need to search for a target without using the GPS Search position, such as searching for a backsight target.

To perform a GPS-aided search from the *Joystick* screen, tap  .

To view the GPS status, tap *GPS* on the *Autolock and Search controls* screen. Alternatively, tap and hold on the target icon.

If you are going into a bad GPS environment for an extended period of time, tap  to stop new positions being added into the GPS Search solution. Tap  to start adding points into the GPS Search solution again.

To perform a standard search throughout the Trimble Survey Controller software, pause GPS Search at any time.

When GPS Search has good data, it can detect bad data and exclude it from its computations. However, if there are more bad positions than good positions, it is difficult for GPS Search to detect and exclude bad positions. Too much bad data in the computations may prevent GPS Search from becoming ready. If this occurs, move to a better GPS environment and then tap *Reset* to restart the GPS Search.

Instrument Settings

When connected to a Trimble VX/S Series, 5600, or 3600 instrument, select *Instruments / Instrument settings* from the main menu to access the *Instrument settings* dialog. Alternatively, tap and hold briefly on the instrument icon in the status bar and then release to enter *Instrument settings*.

Use this dialog to view and set specific controls on the instrument. Depending on the instrument that the controller is connected to, the following functions may be available:

- instrument name
- instrument model
- instrument firmware version
- reticle illumination
- target test
- face 2 backlight
- signal volume
- EDM power save mode
- long range mode

Instrument Name, Instrument Type, and Firmware Version

In Trimble VX/S Series instruments, tap *Name* to enter the instrument name. The instrument name is stored in the Trimble Survey Controller job file, and can be output to [Export custom format files](#) .

The instrument type and firmware version details are also stored in the Trimble Survey Controller job file and output to DC files and Custom ASCII files.

Target test

The target test is used primarily in Trimble Survey Controller Basic when measuring a distance that is to be displayed as a dead record.

If the instrument is moved more than 30 cm from where the last measurement was observed, the HA and VA are updated but the SD reverts to "?" to avoid mistaking the next target's distance for the previously measured target's distance.

Face 2 Backlight (Trimble VX/S Series only)

To enable the face 2 backlight when Trimble Survey Controller is running, select *Face 2 backlight*.

To enable the face 2 backlight when the Trimble CU is not attached to the instrument, press and hold (long press) the  key.

Signal volume (Trimble 5600 only)

A returned signal sounds if a prism is detected. However, if you have activated EDM power save, you will not hear a signal.

EDM power save (Trimble 5600 DR Standard, and 3600 only)

The power save mode turns off the EDM when the instrument is not measuring a distance. The instrument icon appears without the EDM indicator (*).

When the power save mode is off, the EDM is always turned on to receive a signal.

Note - If *EDM power save* is enabled on a Trimble 5600 DR Standard instrument, the tracklight is not available.

Long range (Trimble VX/S Series and 5600 DR Standard, and 3600 only)

Use the long range mode when a strong instrument signal is required for measuring to targets more than one kilometer (about 0.6 miles) away.

Radio Settings

These settings are used with a conventional instrument in robotic mode.

The internal radio settings are set when Trimble Survey Controller connects to the instrument. The remote radio settings are set later when you start the rover survey.

You must configure the radio settings to the same values on the instrument and on the rover radios.

Tip - To configure the instrument Radio channel and Network ID without Trimble Survey Controller, select *Radio settings* on the Trimble VX/S Series instrument through the *Face 2* menu display.

For more information, refer to the documentation for your instrument.

Note - Trimble Survey Controller cannot communicate with the Trimble VX/S Series when the instruments onboard programs are being used. After using the onboard programs, select *Exit* from the *Setup* menu to return to the *Waiting for connection* menu.

Tip - For fast access to configure the Radio settings, tap the instrument icon in the status bar or press the Trimble key, and tap and hold on the Start Robotic icon.

Radio Channel

To avoid conflicting with another user on the same Radio channel, give your instrument radio and rover radio a unique radio channel.

Network ID

To avoid conflicting with another user on the same Network ID, give your instrument radio and rover radio a unique ID number.

Station and Remote Address

To avoid conflicting with another user on the same radio channel, give your instrument and radio a unique address. Enter a station and a remote address between 0 and 99.

Using a TSC2 with an external radio

You can connect a Trimble VX/S Series or Trimble 5600 external radio to the TSC2 controller through the serial port.

To obtain a robotic connection to the Trimble VX/S Series instrument through an external radio you must change the radio port setting in the Trimble VX/S Series communication plug-in.

To do this:

1. Tap the Trimble icon on the Pocket PC Start bar.
2. Tap [Trimble Radio Settings].
3. Configure the [Radio channel] and [Network ID] to the same values as those set on the instrument.

Note - The radio channel and network ID can also be set using the Trimble Survey Controller software.

4. In the [Port Settings] field, select [External].

5. Tap [Ok].

Note - You cannot interchange the Trimble VX/S Series system radios with Trimble 5600 system radios because the radio technology is incompatible.

Note - In some countries, you must obtain a radio license before using your system on a working site. Make sure that you check the regulations for your country.

Instrument Adjustment

Select *Instrument / Adjust* from the main menu to complete the following tests:

HA VA Collimation

Trunnion axis tilt

Autolock collimation

Compensator calibration

On a Trimble VX/S Series instrument, you must perform the HA VA Collimation and the Trunnion axis tilt adjustments together. To start the adjustment wizard, select *Instrument / Adjust / Collimation & Trunnion axis tilt*.

Note - *Instrument / Adjust* is not available during a survey. End the current survey to perform an instrument adjustment.

The HA VA collimation, Trunnion axis tilt, and Autolock collimation instrument adjustments can be performed using Trimble Survey Controller, or on the Trimble VX/S Series instrument through the Face 2 menu display. For more information, refer to the documentation for your instrument.

HA VA Collimation and Trunnion axis tilt adjustments

1. Set up the instrument on a stable surface and follow the prompts to complete the test.

Current adjustment values appear for each test (Horizontal collimation, Vertical collimation, and Trunnion axis tilt). Press the keys lightly to avoid bumping the instrument.

2. Aim at the target and take the first measurement.
3. Turn the instrument away and then re-aim.
4. Take the second measurement.

Note - Do not use *Autolock* during Collimation or Trunnion axis tilt tests.

Position the instrument as follows:

1. Collimation - at least 100 m from the target.
2. Collimation - less than 4°30' (5 gon) from the horizontal plane.
3. Trunnion axis tilt - at least 13°30' (15 gon) from the horizontal plane (for the 5600) or from the VA measured during collimation (for the Trimble VX/S Series).

You must take a minimum of one observation on each face.

Final collimation values must be within tolerance of standard values. If not, the instrument needs to be adjusted mechanically.

For more information, contact your local Trimble dealer.

Autolock collimation

This option is available only for instruments with *Autolock*, and should be performed after the HA VA Collimation adjustment has been completed.

Set up the instrument on a stable surface and follow the prompts. Press the keys lightly to avoid bumping the instrument. Ensure that there are no obstructions between the instrument and the target, which should be at least 100 m apart.

Compensator calibration

The dual axis compensator in the Trimble VX/S Series and 3600 instruments does not require initialization every time the instrument is leveled. However, Trimble recommends that you calibrate the compensator periodically, especially before you take precise measurements.

On a Trimble VX/S Series instrument, calibrate the compensator through the Face 2 menu display. The instrument handle must be **attached** and the Trimble CU must be **unattached**.

For more information, refer to the documentation for your instrument.

To calibrate the compensator in a 3600 instrument:

1. Select *Instruments / Adjust / Compensator calibration*.
2. When prompted, turn the instrument 180° to 0°.
3. Tap *Accept*.

Note - This option is not available for the 5600 because the compensator is calibrated when the instrument is leveled.

Servicing the Trimble VX Spatial Station or Trimble S Series Total Station

The Trimble VX Spatial Station or Trimble S Series Total Station should be serviced every 3000 hours or 13 months (whichever comes first). When the Trimble VX Spatial Station or Trimble S Series Total Station is due for service, the following message appears:

Service warning

Your Trimble Total Station is due for service. Please contact your local Trimble dealer.

When this message appears, you can still use the Trimble VX Spatial Station or Trimble S Series Total Station, but please contact your local Trimble dealer at your earliest convenience to organize servicing.

Note - The Service warning support is available only when using instrument firmware version R10.0.58 or later.

Trimble Survey Controller Basic

Trimble Survey Controller Basic is available when you connect a controller to a Trimble VX/S Series, 3600, or 5600 instrument.

You can use it as follows:

- If a Trimble Survey Controller job was created with a station setup, then Trimble Survey Controller Basic can display raw data, and coordinates based on the station setup in the job.
- If a current station setup does not exist, you can:
 - ◆ Make simple distance or angular checks.
 - ◆ Define the Northing and Easting coordinates for the instrument point in Trimble Survey Controller Basic, set the horizontal circle and then display coordinates for points observed using Trimble Survey Controller Basic.
 - ◆ Key in the elevation for the instrument point and then display the elevation for points observed using Trimble Survey Controller Basic.
 - ◆ Observe to a point with a known reference elevation to compute the instrument elevation and then display the elevation for points observed using Trimble Survey Controller Basic.

To compute the instrument point elevation from a known reference point using Trimble Survey Controller Basic:

1. Ensure that a current station setup does not exist and then start Trimble Survey Controller Basic.
2. Tap *Set* and then enter the *Target height*, *Reference elevation*, and *Instrument height*.
3. If required, enter the *Horizontal angle* and instrument point *Northing* and *Easting*.
4. To measure the reference point, tap *Measure*. The instrument point *Elevation* is computed.
5. To return to Trimble Survey Controller Basic, tap *Accept*.

To change the view on the data displayed, tap the arrow button.

Notes

- If the target height **or** instrument height is null, the Trimble Survey Controller software cannot calculate a VD.
- If target height and instrument height are **both** null, the Trimble Survey Controller software assumes zero for both and can compute the VD, but cannot compute the Elevation.
- If a station setup is computed using Trimble Survey Controller Basic, a scale only projection of 1.0 is used to calculate coordinates.

Tip - To quickly access SC Basic, from the Trimble functions screen, press **0**.

Note - You cannot store measurements in Trimble Survey Controller Basic.

The following table shows Trimble Survey Controller Basic functions.

Tap the ...	to ...
Trimble functions icon	access the <i>Trimble Functions</i> screen
Instrument icon on the status bar	
Target icon	set or modify the target height
Zero softkey	set the instrument horizontal circle to 0
Set softkey	set the horizontal circle
	set the target height
	set the reference elevation, and compute the instrument elevation
	set the instrument point coordinates, and instrument elevation
	set the instrument height
Options softkey	modify the correction values used in Trimble Survey Controller Basic
Clear softkey	reset the angles back to live and clear the slope distance after a measurement
Display view button	switch the display between HA, VA, SD and HA, HD, VD
Press the ...	to ...
Enter key	measure a distance and fix the horizontal and vertical angles

Note - When a survey is running you cannot change:

- the instrument's horizontal circle
- the instrument point coordinates
- [correction](#) values

Trimble Functions

To access the *Trimble Functions* screen, do one of the following:

- tap the instrument icon on the controller screen
- tap the Trimble key (if available) on the controller
- select *Instrument / Trimble Functions* from the Trimble Survey Controller main menu

The *Trimble Functions* screen is available for conventional total stations. Use it to control commonly used instrument functions, and to change instrument settings. Depending on the instrument that the controller is connected to, the following functions may be available:

- STD (EDM Standard mode)
- FSTD (EDM Fast Standard mode)
- TRK (EDM Tracking mode)
- [Tracklight](#)

- Video
- Laser (Laser pointer for DR instruments)
- DR (Direct Reflex) mode
- Electronic level
- Joystick
- Turn to
- Change face
- SC Basic
- Autolock
- Search
- Start Robotic
- Disconnect

Disconnect

The Disconnect function is available when the controller autoconnects to a Trimble VX/S Series instrument in a robotic survey. To restart the survey and reconnect to the instrument, select *Station setup*. Autoconnect is temporarily disabled when you use *Disconnect*.

Once you begin a survey, this option changes to *End survey*.

Trimble Functions shortcuts to the Instrument menu

Shortcuts to certain Instrument menu functions are available from *Trimble Functions*. In the *Trimble Functions* screen, tap and hold on the DR, Laser, Tracklight, Autolock, Search and Start Robotic icons to quickly access their Instrument menu configuration screens.

Geodimeter users

Former Geodimeter users can enter a Geodimeter program number in the *Trimble Functions* screen to launch the corresponding Trimble Survey Controller function. For example, Geodimeter program 26 (Compute join) is the same as the Trimble function *Compute inverse*.

GDM Data Output

Use GDM data output to stream horizontal angle, vertical angle, slope distance, northing, easting, elevation, date, and time data from a robotic Trimble CU or TSC2 controller connection to a Trimble VX/S Series instrument, or directly from the COM port of the Trimble VX/S Series instrument.

To enable GDM streamed data output:

1. From the main menu select *Instrument / GDM data output*.
2. Set the *Streamed data* to either *After measurement* or *Continuous*.
3. Select the *Streamed format*.

If the *Streamed format* is set to *User defined*, configure the GDM labels.

4. If necessary, configure the *Port details*.

GDM data output remains enabled while the *GDM data output* form is open. To access other functions in the Trimble Survey Controller software and leave *GDM data output* running, use *Switch to* or *Menu*.

To stop GDM data output, tap *Stop*, or close the *GDM data output* form.

Supported labels

Label	Text	Description
7	HA	Horizontal angle
8	VA	Vertical angle
9	SD	Slope distance
37	N	Northing
38	E	Easting
39	ELE	Elevation
51	Date	Date
52	Time	Time

Notes

- If streamed output is on and no new distance is available, the HA and VA labels are sent rather than the user defined labels.
- If streamed output is on, and the instrument is in Autolock mode but it is not locked onto a target, GDM data is not sent. When using Autolock mode, the instrument must be locked onto a target for any GDM data to be sent.
- The angle and distance units match the Trimble Survey Controller system settings.
- The northing, easting, and elevation units match the Trimble Survey Controller system setting.
- Before the system can output northing, easting, and elevation, you must complete a station setup. Otherwise, the system outputs 0, 0, 0.
- If you want to stream data from the COM port on the Trimble CU robotic holder, or the Trimble VX/S Series instrument, you must connect the cable **before** you open the GDM data output form. Otherwise, the COM port is not available.

Coordinate System

Coordinate System

A coordinate system consists of a projection and datum transformation and, sometimes, additional horizontal and vertical adjustments.

When you create a job, select a coordinate system by one of the following methods:

- [Scale factor only](#)
- Select from library
- Key in parameters
- [No projection/ no datum](#)

If you need to perform a GPS site calibration, or change the parameters manually after selecting the coordinate system, select *Files / Properties of current job / Coord. sys.*

Where the job parameters are keyed in, or a calibration is used, the coordinate system settings are displayed as "Local site".

If you modify the coordinate system by calibration or by manually changing the parameters, you must do so before you compute offsets or intersection points, or stake out points in the local coordinate system.

To set up a [ground coordinate system](#) for the job, choose the *Select from library* or *Key in* parameters option.

To customize the coordinate systems available on the Trimble Survey Controller software, use the Coordinate System Manager software. For more information see [Customizing the Coordinate System Database](#).

Customizing the Coordinate System Database

You can customize the coordinate system database used by the Trimble Survey Controller software. This enables you to:

- Reduce the number of coordinate systems available in the Trimble Survey Controller software so that it includes only the ones you need.
- Customize existing coordinate systems definitions or add new coordinate system definitions.
- Include GPS site calibrations in the coordinate system library.

You must use the Coordinate System Manager software to modify the Coordinate System Database (CSD) and then transfer the modified database to the [Trimble data] folder on the Trimble controller. When a [custom.csd] file exists in the [Trimble data] folder, the Trimble Survey Controller software uses the custom.csd database instead of the coordinate system database built into the Trimble Survey Controller software.

Note - The Coordinate System Manager software is installed at the same time as your Trimble Office software, for example, Trimble Geomatics Office.

There are a number of ways you can use the Coordinate System Manager software to customize the coordinate systems. From the following options, choose the one that best suits your needs.

To reduce a coordinate system library to one or more coordinate systems, zones, and sites:

1. Run the Coordinate System Manager software on your office computer.
2. Do one or more of the following to hide the required element:
 - ◆ **Coordinate system:** In the left pane of the *Coordinate Systems* tab, select the coordinate system(s) that you do not want, right click and then select *Hide*.
 - ◆ **Zone:** In the left pane of the *Coordinate Systems* tab, select a coordinate system, from the right pane, select the Zone(s) you do not want, right click and then select *Hide*.
 - ◆ **Site:** From the *Sites* tab, right click the site(s) you do not want and then select *Hide*.
3. Select *File / Save As*.
4. Name the file [custom.csd] and then click **Save**.

By default, the file is saved in [Program Files\Common Files\Trimble\GeoData] with the extension *.csd.

To export only User defined coordinate systems:

1. Run the Coordinate System Manager software on your office computer.
2. Select *File / Export*.
3. Select *User-defined records only* and then click **OK**.
4. Name the file [custom] and then click **Save**.

By default, the file is saved in [Program Files\Common Files\Trimble\GeoData] with the extension *.csw.

Tips for using the Coordinate System Manager software

- ◆ To make multiple selections, press **CTRL** or **SHIFT**.
- ◆ To hide records, right click the selection and then select *Hide*.
- ◆ To display hidden records, select *View / Hidden Records*. Hidden records are displayed with a dark red icon.
- ◆ To unhide hidden records, right click hidden record(s) and then clear the *Hide* check box.

For more information, see the Coordinate System Manager Help.

Note - If a GPS site calibration has been saved using your Trimble Office software, a site with the assigned name is added to the *Sites* tab and a Site group is created in the *Coordinate Systems* tab, if required. When you create a customized coordinate system that includes sites saved by the Trimble Office software, include those sites created in the *Sites* tab. The Site group in the *Coordinate Systems* tab contains the coordinate system details **referenced** by the sites saved in the *Sites* tab, but the calibration details are **only** stored in the site in the *Sites* tab.

Transferring Customized Coordinate Systems

You can transfer the file to the controller using the Trimble Data Transfer utility or Microsoft ActiveSync technology. The file must be called [custom.csd] for the Trimble Survey Controller software to access it.

A file transferred by the Data Transfer utility is automatically renamed and saved to the [Trimble data] folder. If you transfer the file using ActiveSync technology, you must copy the file to the [Trimble data] folder and then rename the file to [custom.csd].

For more information on transferring a file from a Trimble controller to an office computer, see [Connecting the controller to the office computer using Microsoft ActiveSync technology](#).

When the *Open* dialog appears, select *CSD Files (*.csd)* or *CSD Files (*.csw)* from the *Files of type* list.

To select a custom site in Trimble Survey Controller software:

1. From the main menu, select *Files / New job*.
2. Enter the *Job name*.
3. In the *Properties* group, tap the *Coord sys* button.
4. Choose *Select from library* and then tap *Next*, if required.
5. If this is a new custom.csd file, a warning appears. Tap *OK* to accept.
6. In the *System* field, select [*User sites*].
7. In the *Site* field, select the required site.
8. If required, select a geoid model.
9. To return to the *New job* dialog, tap *Store*.
10. In the *New job* dialog, tap *Accept* to save the new job.

Scale Factor Only

Use this projection type when you are doing a conventional-instrument only survey with a local scale factor. This option is useful for areas that use a local scale factor to reduce distances to the local coordinate system.

To choose a Scale factor only projection:

1. Create a new job.
2. Select *Scale factor only* from the *Select coordinate system* menu.
3. Enter a value in the *Scale* field and then tap *Store*.

Projection

A projection is used to transform local geodetic coordinates into local grid coordinates.

Note - Enter an appropriate default height value for the Trimble Survey Controller software to correctly calculate a sea level correction and then apply it to the grid coordinate.

GPS coordinates are relative to the WGS-84 ellipsoid. To work in local grid coordinates, you must specify a projection and datum transformation.

You can specify a projection:

- when a job is created and you have to choose a coordinate system (select from a list, or key in)
- during a survey (you calculate values by performing a calibration)
- in the Trimble Geomatics Office software, when the data is transferred.

Do not change the coordinate system or calibration after you have staked out points, or computed offset or intersection points.

If a projection and datum transformation are specified, you can reduce any discrepancies between the WGS-84 coordinates and the local grid coordinates by performing a site calibration.

Ground Coordinate System

If you require coordinates to be at ground level instead of projection level, use a ground coordinate system. When you select a ground coordinate system, grid distances equal ground distances.

To set up a ground coordinate system, when you create a job:

1. Specify a coordinate system by choosing the *Select from library*, or *Key in parameters* option.
2. To use ground coordinates with the selected coordinate system, tap the Page down button, and then from the *Coordinates* field, do one of the following:
 - ◆ To key in a scale factor, select *Ground (Keyed in scale factor)*.
 - ◆ To let the Trimble Survey Controller software calculate the scale factor, select *Ground (Calculated scale factor)*. Enter values in the *Project Location* group to compute the scale factor.

The computed scale factor allows for the projection scale factor at the Project Location in order to ensure that the combined factor (grid scale factor plus elevation factor) at the Project Location equals 1.

The Trimble Survey Controller software applies the ground scale factor to the projection.

3. To add offsets to the coordinates, enter a value in the *False northing offset* and *False easting offset* fields as required.

Note - When working with a ground coordinate system the reported ground distance may not be the same as the reported grid distance. The reported ground distance is simply the ellipsoid distance corrected for the average height above the ellipsoid. However the grid distance is computed between the ground coordinates of the points, and is therefore based on a coordinate system that provides a combined scale factor of 1 at the Project Location.

Note - Use offsets to differentiate ground coordinates from unmodified grid coordinates.

Project Height

The project height can be defined as part of the coordinate system definition when creating a new job. To find it, select *Files / Properties of current job* for a coordinate system in either the *Library* or *Key in projection* dialogs.

If a point has no elevation, the Trimble Survey Controller software uses the project height in Cogo calculations. If you combine GPS and 2D conventional observations, set the *Project height* field to approximate the height of the site. This height is used with 2D points to calculate grid and ellipsoid distances from measured ground distances.

In 2D surveys where a projection has been defined, enter a value for the project height that approximates the height of the site. You need this value to reduce measured ground distances to ellipsoid distance, and to compute coordinates.

If you edit the project height (or any other local site parameter) after calibrating, the calibration becomes invalid and must be reapplied.

No Projection / No Datum

To select a coordinate system with an undefined projection and datum, when you create a job:

1. Tap the *Coord. sys* button and select *No projection/no datum*.
2. Set the *Coordinates* field to *Ground*, and enter a value (average site height) in the *Project height* field to use ground coordinates after a site calibration. Alternatively, set the *Coordinates* field to *Grid*.
3. Select the *Use geoid model* check box, and select a geoid model to calculate a Geoid/Inclined plane vertical adjustment after a site calibration.

Any points measured using GPS are displayed only as WGS84 coordinates. Any points measured using a conventional instrument are displayed with null (?) coordinates.

The Trimble Survey Controller software performs a calibration that calculates a Transverse Mercator projection and a Molodensky three-parameter datum transformation, using the supplied control points. The project height is used to compute a scale factor for the projection so that ground coordinates can be computed at elevation.

Horizontal Adjustment

A horizontal adjustment is a least-squares adjustment that is applied to minimize the differences between transformed grid coordinates and local control points.

Horizontal and vertical adjustments are calculated if you perform a calibration when a projection and datum transformation are defined.

Trimble recommends that you use a minimum of four control points to compute a horizontal and vertical adjustment.

Alternatively, you can key in horizontal adjustment parameters when you start a new job.

Vertical Adjustment

This is a least-squares adjustment that is applied to convert (ellipsoid) heights to elevation. It is computed when you do a calibration. A minimum of one point is required to compute the adjustment. If more points are used, an inclined plane adjustment can be calculated.

If you have a geoid model selected, you can choose to use only the geoid model, or to use the geoid model and do an inclined plane adjustment. Trimble recommends that you use a geoid model to obtain more accurate orthometric heights from your GPS measurements.

You can specify the type of vertical adjustment when you create a job. Set this parameter when you choose the coordinate system. You can also key in the parameters when you create a job.

To change the parameters for the current job, from the main menu select *Files / Properties of current job*, tap *Coord sys* and then select *Key in parameters / Vertical adjustment*.

Note - When the Projection is set to *Scale factor only*, the *Datum transformation*, *Horizontal adjustment*, and *Vertical adjustment* options are not available. Select a non *Scale factor only* projection to access the other parameters.

Coordinate Systems

Before starting a GPS survey, decide which coordinate system to use. This topic discusses some things to consider when making this decision.

[Choosing a Coordinate System for a Conventional Survey](#)

[Choosing a Coordinate System for a GPS Survey](#)

[GPS Coordinate System](#)

[Local Coordinate Systems](#)

[Calibration](#)

[Using a Datum Grid File](#)

[Using a Geoid Model](#)

[Working with Ground Coordinates](#)

If you intend to combine conventional observations with GPS measurements, read the whole of this topic. To make only conventional observations, see [Choosing a Coordinate System for a Conventional Survey](#).

Choosing a Coordinate System for a Conventional Survey

When surveying using conventional equipment, it is important to choose a suitable coordinate system.

For example, if a job is to combine GPS measurements with conventional observations, choose a coordinate system that lets you view GPS observations as grid points. This means that you must define a projection and a datum transformation. For more information, see [Creating a job](#).

Note - You can complete the field work for a combined survey without defining a projection and a datum transformation, but you will not be able to view the GPS observations as grid coordinates.

If you want to combine GPS measurements with two-dimensional conventional observations, specify a project height for the job. For more information, see [Project Height](#).

If a job is to contain conventional observations only, select one of the following when you create the job:

- A typical coordinate system and zone that provide mapping plane coordinates. For example, State Plane coordinates.
- Scale factor only.

In a conventional survey, measurements are made at ground level. To compute coordinates for these measurements, observations are reduced to grid level. The specified scale factor is applied to measured distances to reduce them from ground to grid.

The *Scale factor only* option is useful for areas that use a local scale factor to reduce distances to grid.

Tip - If you are not sure what coordinate system to use, select the *Scale factor only* projection and enter a scale factor of 1.000.

Choosing a Coordinate System for a GPS Survey

When you create a new job, the Trimble Survey Controller software prompts you to define the coordinate system you are using. You can select a system from the library, key in the parameters, select *Scale factor only*, or select *No projection / no datum* transformation. For more information, see [Creating a job](#).

The most rigorous coordinate system consists of four parts:

- datum transformation
- map projection
- horizontal adjustment
- vertical adjustment

Note - To conduct a realtime survey in terms of local grid coordinates, define the datum transformation and map projection before starting the survey.

Tip - In the *Coordinate view* field, select *Local* to display local geodetic coordinates. Select *Grid* to display local grid coordinates.

When WGS84 coordinates are transformed onto the local ellipsoid, using a datum transformation, local geodetic coordinates result. Local geodetic coordinates are transformed into local grid coordinates using the map projection. The result is Northing and Easting coordinates on the local grid. If a horizontal adjustment is defined, it is applied next, followed by the vertical adjustment.

GPS Coordinate System

GPS measurements are referenced to the 1984 World Geodetic System reference ellipsoid, known as WGS84. However, for most survey tasks, results in terms of WGS84 have little value. It is better to display and store results in terms of a local coordinate system. Before you start a survey, choose a coordinate system. Depending on the requirements of the survey, you can choose to give the results in the national coordinate system, a local coordinate grid system, or as local geodetic coordinates.

When you have chosen a coordinate system, search your survey archives for any horizontal and vertical control points in that coordinate system that are in the area to be surveyed. You can use these to calibrate a GPS survey. For more information, see [Calibration](#).

Local Coordinate Systems

A local coordinate system simply transforms measurements from a curved surface (the earth) onto a flat surface (a map or plan). Four important elements constitute a local coordinate system:

- local datum
- datum transformation
- map projection
- calibration (horizontal and vertical adjustments)

When you survey using GPS, consider each of these.

Local Datum

Because an exact model of the earth's surface cannot be created mathematically, localized ellipsoids (mathematical surfaces) have been derived to best represent specific areas. These ellipsoids are sometimes referred to as local datums. NAD83, GRS80, and AGD66 are examples of local datums.

Datum Transformation

GPS is based on the WGS84 ellipsoid, which is sized and positioned to best represent the entire earth.

To survey in a local coordinate system, the WGS84 GPS positions must first be transformed onto the local ellipsoid using a datum transformation. Three types of datum transformation are commonly used. Alternatively, you can choose not to use a transformation at all.

The datum transformations are as follows:

- three-parameter - This assumes that the rotational axis of the local datum is parallel with the rotational axis of WGS84. The three-parameter transformation involves three simple translations in X, Y, and Z. The three-parameter transformation that the Trimble Survey Controller software uses is a Molodensky transformation, so there may also be a change in ellipsoid radius and flattening.

Note - Positions on a local datum are commonly called "local geodetic coordinates". The Trimble Survey Controller software abbreviates this to "Local".

- Seven-parameter - This is the most complex transformation. It applies translations **and** rotations in X, Y, and Z, as well as a scale factor.
- Datum grid - This uses a gridded data set of standard datum shifts. By interpolation, it provides an estimated value for a datum transformation at any point on that grid. The accuracy of a datum grid depends on the accuracy of the gridded data set it uses. For more information, see [Using a Datum Grid File](#).

Map Projection

Local geodetic coordinates are transformed into local grid coordinates using a map projection (a mathematical model). Transverse Mercator and Lambert are examples of common map projections.

Note - Positions on a map projection are commonly called "local grid coordinates". The Trimble Survey Controller software abbreviates this to "Grid".

Horizontal and Vertical Adjustments

If published datum transformation parameters are used, slight discrepancies can exist between local control and GPS-derived coordinates. These discrepancies can be reduced using minor adjustments. The Trimble Survey Controller software calculates these adjustments when you use the *Site calibration* function. They are called horizontal and vertical adjustments.

Calibration

Calibration is the process of adjusting projected (grid) coordinates to fit the local control. You can key in a calibration, or let the Trimble Survey Controller software calculate it. You should calculate and apply a calibration before:

- staking out points
- computing offset or intersection points

The rest of this section describes how to perform a calibration using the Trimble Survey Controller software. To key in a calibration, see [Creating a job](#).

Calibration Calculations

Use the Trimble Survey Controller software system to perform a calibration in one of two ways. Each method results in the computation of different components, but the overall result is the same if enough reliable control points (coordinates in your local system) are used. The two methods are:

- If you use published datum transformation parameters and map projection details when creating a job, and if you provide enough control points, the Trimble Survey Controller software performs a calibration that computes horizontal and vertical adjustments. Horizontal control points allow scale error anomalies in the map projection to be removed. Vertical control allows local ellipsoid heights to be transformed into useful orthometric heights.

Tip - Always use published parameters if they exist.

- If you do not know the map projection and datum transformation parameters when creating the job and defining the local coordinate system, specify *No projection / no datum*.

Then specify whether grid or ground coordinates are required after a site calibration. When ground coordinates are required, you must specify the project height. In this case, the Trimble Survey Controller software performs a calibration that calculates a Transverse Mercator projection and a Molodensky three-parameter datum transformation using the supplied control points. The project height is used to compute a ground scale factor for the projection so that ground coordinates are computed at that height.

The following table shows the output of a calibration when various data is supplied.

Projection	Datum transformation	Calibration output
Yes	Yes	Horizontal and vertical adjustment
Yes	No	Datum transformation, horizontal and vertical adjustment
No	Yes	Transverse Mercator projection, horizontal and vertical adjustment
No	No	Transverse Mercator projection, zero datum transformation, horizontal and vertical adjustment

Local Control for Calibration

Trimble recommends that you observe and use a minimum of four local control points for the calibration calculation. For best results, local control points should be evenly distributed over the job area as well as extending beyond the perimeter of the site (assuming that the control is free of errors).

Tip - Apply the same principles as you would when placing control for photogrammetric jobs. Make sure that the local control points are evenly distributed to the extent of the job area.

Why Calibrations Are Needed

If you calibrate a project and then survey in real time, the Trimble Survey Controller software gives real-time solutions in terms of the local coordinate system and control points.

Operations That Require Calibration

Note - Perform a calibration at any time, but always complete the calibration *before* staking out any points, or computing offset or intersection points.

If no datum and no projection are defined, you can only stake out lines and points that have WGS84 coordinates. Displayed bearings and distances are in terms of WGS84.

Specify a projection before staking out arcs, roads, and DTMs. The Trimble Survey Controller software does not assume that WGS84 is the local ellipsoid, so you must also define a datum.

Without a datum transformation, you can only start a real-time base survey with a WGS84 point.

For information on how to perform a calibration, see [Calibration](#).

The following diagram shows the order of calculations performed when a calibration is calculated.

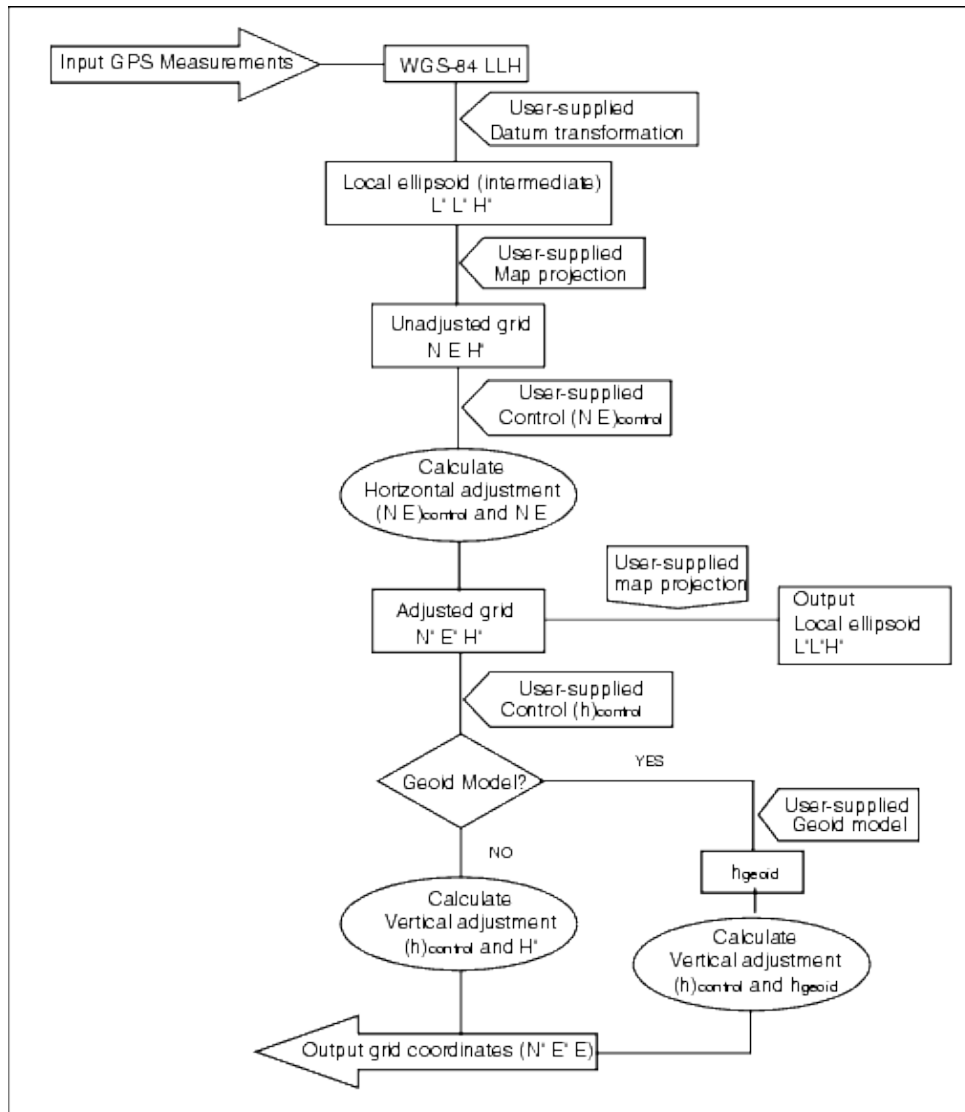

Copying Calibrations

You can copy a calibration from a previous job if the new job is completely encompassed by that initial

calibration. If a portion of the new job lies outside the initial project area, introduce additional control to cover the unknown area. Survey these new points and compute a new calibration. Use this as the calibration for the job.

Tip - To copy the calibration from an existing job to a new job, make sure that the **current** job you want to copy has the calibration that you require in the new job. Then create the new job. A new job uses the default values from the previous job. Use the softkeys on the Job properties screen to change the defaults.

Using a Datum Grid File

A datum grid transformation uses interpolative methods to estimate the value of the datum transformation at any point in the area covered by the datum grid files. Two gridded datum files are required for this interpolation—a latitude datum grid file and a longitude datum grid file. When you export a datum grid using the Trimble Geomatics Office software, the two datum grid files associated with the current project are combined into a single file for use in the Trimble Survey Controller software.

Selecting a Datum Grid File

To select a datum grid file when creating a job, do one of the following:

- Select a coordinate system from the library provided in the Trimble Survey Controller software. Select the *Use datum grid* check box. In the *Datum grid* field, select the file that you want to use.
- Key in the coordinate system parameters. Select *Datum transformation* and set the *Type* field to Datum grid. In the *Datum grid* field, select the file that you want to use.

Note - The U.S. State Plane 1927 and the U.S. State Plane 1983 coordinate systems in the Trimble Survey Controller software use three-parameter transformations.

To select a datum grid file for use in the current job:

1. From the main menu, select *Files / Properties of current job - Coord. Sys.*
2. Do one of the following:
 - ◆ If *Key in parameters* is selected, select *Next*. Select *Datum transformation* and set the *Type* field to Datum grid. In the *Datum grid* field, select the file that you want to use.
 - ◆ If *Select coordinate system* is selected, select *Next*. Select the *Use datum grid* check box. In the *Datum grid* field, select the file that you want to use.

The semi-major axis and flattening values for the selected datum grid file are displayed. These details overwrite any already provided by a specified projection.

Using a Geoid Model

The geoid is a surface of constant gravitational potential that approximates mean sea level. A geoid model or Geoid Grid file (*.ggf) is a table of geoid-ellipsoid separations that is used with the GPS ellipsoid height observations to provide an estimate of elevation.

The geoid-ellipsoid separation value (N) is obtained from the geoid model and is subtracted from the ellipsoid height (H) for a particular point. The elevation (h) of the point above mean sea level (the geoid) is the result. This is illustrated in the following diagram.

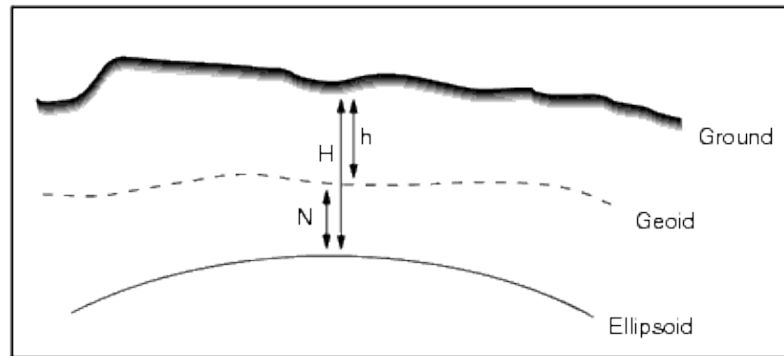

Note - For correct results, the ellipsoid height (H) must be based on the WGS-84 ellipsoid.

When you select geoid model as the vertical adjustment type, the Trimble Survey Controller software takes the geoid-ellipsoid separations from the geoid file chosen, and uses them to display elevations on the screen.

The benefit of this function is that you can display elevations without having to calibrate on elevation benchmarks. This is useful when local control or benchmarks are not available, as it makes it possible to work "on the ground" rather than on the ellipsoid.

Note - If you are using a geoid model in a Trimble Geomatics Office project, make sure you transfer that geoid file (or the relevant part of it) when transferring the job into a Trimble controller.

Selecting a Geoid File

To select a geoid file when creating a job, do one of the following:

- Select a coordinate system from the library provided in the Trimble Survey Controller software. Select the *Use geoid model* check box. In the *Geoid model* field, select the file to be used.
- Key in the coordinate system parameters. Select *Vertical adjustment* and set the *Type* field to *Geoid model* or *Geoid/Inclined plane* as required. (Select *Geoid/Inclined plane* if you intend to key in the inclined plane adjustment parameters.)

To select a geoid file for the current job:

1. From the main menu select *Files / Properties of current job - Coord. Sys.*
2. Do one of the following:
 - ◆ If the *Key in parameters* screen is selected, select *Next*. Select *Vertical adjustment* and set the *Type* field to *Geoid model* or *Geoid/Inclined plane* as required. (If you intend to key in the inclined plane adjustment parameters, select *Geoid/Inclined plane*.)
 - ◆ If the *Select coordinate system* screen is selected, select *Next*. Select the *Use geoid model* check box. In the *Geoid model* field, select the file to be used.

Working with Ground Coordinates

If you need coordinates to be at ground level instead of projection level (for example, in areas of high elevation), use a ground coordinate system.

When you select a ground coordinate system, grid distances equal ground distances.

Setting up a Ground Coordinate System

When you set up a ground coordinate system in a Trimble Survey Controller job, the software applies a ground scale factor to the coordinate system projection definition.

To set up a ground coordinate system when creating a job:

1. Define the coordinate system for the job. Do one of the following:
 - ◆ Choose the *Select from library* option to select a coordinate system from the library provided in the Trimble Survey Controller software. Tap *Next*.
 - ◆ Choose the *Key in parameters* option to key in the coordinate system parameters. Tap *Next* and then select *Projection*.
2. In the *Coordinates* field, choose an option to define the ground scale factor.

Additional fields appear below the *Coordinates* field.

3. If you select the *Ground (keyed in scale factor)* option, enter a value in the *Ground scale factor* field.
4. In the *Project location* group, enter values in the fields as required. Tap *Here* to enter the current autonomous position derived by the GPS receiver. The autonomous position is displayed in terms of WGS-84.

The project height is used with 2D points to reduce ground distances in Cogo calculations. For more information, see [Project Height](#). If you select the *Ground (calculated scale factor)* option, the fields are used to calculate the ground scale factor. When the fields are completed, the computed ground scale factor is displayed in the *Ground scale factor* field.

5. To add offsets to the coordinates, enter a value in the *False northing offset* and *False easting offset* field, as required.

Note - Use offsets to differentiate ground coordinates from unmodified grid coordinates.

To configure a ground coordinate system for the current job:

1. From the main menu, select *Files / Properties of current job - Coord.Sys*.
2. Do one of the following:
 - ◆ If the *Key in parameters* screen is selected, tap *Next* and then select *Projection*. Select an option from the *Coordinates* field. Complete the fields below as required.
 - ◆ If the *Select coordinate system* screen is selected, tap *Next*. Select an option from the *Coordinates* field and then complete the fields below as required.

Options Softkey

This softkey appears in only some screens. It allows you to change the configuration for the task being performed.

If you make changes using the *Options* softkey, they only apply to the current survey or calculation. The

changes do not affect the current Survey Style or the job configuration.

Distances setting options

The computed area varies according to the *Distance* display setting. The following table shows the effect of the distance setting on the area calculated.

Distances setting	Computed area
Ground	At the average ground elevation
Ellipsoid	On the ellipsoid surface
Grid	Directly off the grid coordinates

Traverse Options

Use these options to specify how a traverse calculation is adjusted.

Field	Option	What it does
Adjustment method	Compass	Adjusts the traverse by distributing the errors in proportion to the distance between traverse points
	Transit	Adjusts the traverse by distributing the errors in proportion to the northing and easting ordinates of the traverse points
Error distribution		
Angular	Proportional to distance	Distributes the angular error among the angles in the traverse based on the sum of the inverses of the distances between traverse points
	Equal proportions	Distributes the angular error evenly among the angles in the traverse
	None	Does not distribute the angular error
Elevation	Proportional to distance	Distributes the elevation error in proportion to the distance between traverse points
	Equal proportions	Distributes the elevation error evenly among the traverse points
	None	Does not distribute the elevation error

Note - The *Compass* option is the same as the Bowditch method of adjustment.

For information about calculating and adjusting a traverse, see [Traverses](#).

Measure Display

Use the *Measure display* field to configure how the observations are displayed on the controller.

See the [Conventional Instrument - Corrections](#) table for a description of the measure display options and the corrections that are applied.

Subdivide Pts Code

When you subdivide a line or an arc, a number of points are created. Use the *Subdivide pts code* field to specify the code that the new points will be allocated. Choose from the name or the code of the line or arc that

is to be subdivided.

Coordinate View Settings

To change the *Coordinate view* setting (when reviewing a job) for a point that you want to view:

1. When reviewing the database, highlight the point record and tap *Enter*.
2. Tap *Options* and set the *Coordinate view* field as required.

If the coordinate value for a point is *?*, one of the following situations may have occurred:

- The point may be stored as a GPS point but with the *Coordinate view* field set to *Local* or *Grid* and a datum transformation and projection not defined. To correct this, change the *Coordinate view* setting to *WGS-84*, define a datum transformation and/or projection, or calibrate the job.
- The point may be stored as a polar vector from a point which has been deleted. To correct this, restore the point.
- In a 2D survey, a projection may have been defined with the project height at null. To correct this, set the *Project height* to approximate the site elevation.

Projection Grids

Use a projection grid to handle projection types that are not directly supported by the Trimble coordinate system routines. A projection grid file stores local latitude and longitude values that correspond to regular northing/easting positions. Depending on the direction of the conversion, either projection or local latitude/longitude positions are interpolated from the grid data for points within the grid extents.

Use the Coordinate System manager to generate the defined projection grid (*.pjt) file.

For more information, refer to the *Coordinate System Manager Help*.

Use the Data Transfer utility or Microsoft ActiveSync technology to transfer the *.pjt file to the controller. For more information, refer to the Trimble Survey Controller [File Transfer Help](#), Data Transfer Help or Microsoft ActiveSync Help.

To use the projection grid in Trimble Survey Controller:

1. From the main menu, select *Files / New job*.
2. Enter the *Job name*.
3. In the *Properties* group, tap the *Coord sys* button.
4. Select *Key in parameters*, if required, tap *Next*.
5. In the *Key in parameters* dialog, select *Projection*.
6. In the *Type* field, select *Projection grid* from the drop-down list.
7. In the *Projection grid file* field, select the required grid file.
8. If required, select the *Use shift grid* check box.
9. Tap *Accept* twice, to return to the *New job* dialog.

10. In the *New job* dialog, tap *Accept* to save the new job.

Shift Grids

Initial projection coordinates are projections that are computed using specified projection routines. Some countries use shift grids to apply corrections to these coordinates. The corrections are generally used to fit the initial coordinates to local distortions in the survey framework, and so cannot be modelled by a simple transformation. You can apply a shift grid to any type of projection definition. Coordinate systems that use shift grids include the Netherlands RD zone, and the United Kingdom OS National Grid zones.

Note - The OS National Grid zones are currently used as a specific projection type but can also be used as a Transverse Mercator projection plus shift grid.

For more information, contact your local Trimble dealer.

Use the Coordinate System manager to generate a shift grid (*.sgf) file. For more information, refer to the *Coordinate System Manager Help*.

Use the Trimble Data Transfer utility or Microsoft ActiveSync technology to transfer the shift grid (*.sgf) file to the controller. The file is stored in [\\Trimble Data].

For more information, refer to the Trimble Data Transfer Help or Microsoft ActiveSync Help.

To apply a shift grid to a [projection definition](#):

1. In the *Projection* dialog, select the *Use shift grid* check box.
2. In the *Shift grid file* field that appears, select the required file from the drop-down list.

File Transfer

Import / Export menu

This menu lets you send and receive data to and from another device, export and import fixed format files, export and import custom format files and transfer files between controllers.

For more information, see:

[Send and Receive data to and from another device](#)

[Export Fixed Format Files](#)

[Import Fixed Format Files](#)

[Export Custom Format Files](#)

[Import Custom Format Files](#)

[Email](#)

[File Transfer Application](#)

Transferring Files between the Controller and the Office Computer

This topic describes how to transfer data between a Trimble controller and an office computer. It lists the types of files that can be transferred, and shows how to connect the equipment for transfer.

For more information, see:

[File transfer between a Trimble controller and the office computer](#)

[Connecting the controller to the office computer using Microsoft ActiveSync technology](#)

[Using Bluetooth to Connect a Trimble CU to an Office Computer](#)

[Using Bluetooth to Connect a Trimble TSC2 to an Office Computer](#)

[Using WiFi to Connect a TSC2 controller to an Office Computer](#)

[Using the Trimble Data Transfer Utility](#)

[Using Microsoft Explorer with the Microsoft ActiveSync technology enabled](#)

[File conversion](#)

[Transferring a Geodimeter \(GDM\) job file](#)

[Transferring a Zeiss M5 file](#)

[Transferring ESRI Shapefiles](#) (available only with the [High Accuracy GIS](#) option)

[AutoCAD Land Desktop software](#)

File transfer between a Trimble controller and the office computer

You can transfer various types of files between a Trimble controller and the office computer, including data collector (.dc) files, feature code files, digital terrain models (DTM), and language files. The file transfer process on the Trimble controller is controlled by the office computer software, once you have established a connection between the controller and office computer using the Microsoft ActiveSync technology.

You can transfer files using:

- The Trimble Data Transfer utility with Microsoft ActiveSync technology enabled
- Microsoft Explorer with the Microsoft ActiveSync technology enabled

To use the Microsoft ActiveSync technology, you must first install it from the Trimble Survey Controller software CD.

You can also transfer data to and from a Trimble controller using other Trimble software packages. For more information, refer to the help provided with the Trimble office software.

Connecting the controller to the office computer using Microsoft ActiveSync technology

To transfer Trimble Survey Controller files between the Trimble Survey Controller software and the office computer, you must use Microsoft ActiveSync technology on either a Guest or Partnership connection.

Note - To connect using a LAN (Local Area Network), you must create a partnership. However, you cannot create a partnership on a LAN connection. To create a partnership, you must connect the controller to the office computer using a serial cable, USB, or infrared connection.

To establish the connection:

1. Make sure that the Trimble controller and office computer are switched on.
Disconnect any devices that are communicating with the controller, and close down any applications to ensure that the communications ports are available.
2. On the office computer, select *Start / Programs / Microsoft ActiveSync* to start the ActiveSync technology.

You only need to do this the first time to configure the connection settings. Subsequent connections start Microsoft ActiveSync technology automatically.

3. In Microsoft ActiveSync, select *File / Connection Settings* to configure the connection method. Select the appropriate option for *Serial/Infrared* and specify the communications port, USB, or Network.
4. Connect the Trimble controller to the office computer. Use one of the following methods:
 - ◆ Serial cable
 - ◆ USB cable (using the Multiport adaptor)
 - ◆ Network (Ethernet) card (using the Multiport adaptor)
 - ◆ Infrared (if your controller supports it)
 - ◆ Docking station (connected by USB to the office computer. Only available with a Trimble CU)
 - ◆ Bluetooth wireless technology (available only with a Trimble CU)
5. The Microsoft ActiveSync icon on your Windows taskbar will start spinning and the Trimble controller prompts you with the message, "Connect to desktop". Tap *Yes*.
6. If the message does not appear on the Trimble controller and the Microsoft ActiveSync icon does not spin, there is a connection problem. Check that the connection settings in the Microsoft ActiveSync technology are correct and that there are no applications using the COM port on the Trimble controller.

If the controller fails to connect, a message may appear to advise that the connection is busy. Alternatively, an Error 678 message may appear to advise that the connection is not established. Remove the cable connected to the controller, perform a soft reset, and then reconnect the cable. When the cable is reconnected the [Connect to desktop] message appears, select [Yes] to connect.

For more information on how to perform a soft reset, see [Perform a soft reset](#).

If you have not already created a partnership between this computer and the controller, the Microsoft ActiveSync connection wizard prompts you to do so during the connection process. Creating a partnership is not essential, but it does have some advantages, as shown in the following table.

Connection Type	Advantages	Disadvantages
Guest	<p>Fewer questions to answer on initial connection</p> <p>Safer (because synchronization cannot adversely impact data either on your controller or your PC)</p> <p>For use on borrowed or shared computers</p>	<p>Slower subsequent connections (one more step per connection that requests for partnership)</p> <p>LAN connection is not possible</p>
Partnership	<p>Fast subsequent connections (one fewer step per connection)</p> <p>Once a partnership is established, you can connect to the office computer through a LAN (the fastest connection)</p> <p>The controller clock is set to match the office computer clock</p>	<p>More questions to answer on initial connection</p> <p>Synchronization is not supported on the controller</p> <p>If the clock on the office computer is wrong, it will make the clock on the controller wrong</p> <p>Partnership is deleted when</p>

	you perform a hard reset on the controller
--	--

To create a Partnership:

1. On the [New Partnership] dialog select [Yes] then [Next].
2. To allow only one partnership with this controller, select [Yes] then [Next].
3. Select the synchronization settings, we recommend clearing all check boxes. Select [Next] to continue.
4. The setup is now complete, select [Finish] to exit the wizard. You have now completed the ActiveSync connection process and formed a partnership.

To transfer Trimble Survey Controller files using Trimble Data Transfer, see [Using the Trimble Data Transfer Utility](#).

For more information, refer to the Microsoft ActiveSync Help. On the office computer, click *Start / Programs / Microsoft ActiveSync*.

Note - When the Microsoft ActiveSync technology is enabled, it takes control of the communication ports on the computer. This makes them unavailable to other applications. To transfer files to and from earlier versions of the Trimble Survey Controller software or Trimble GPS receivers, you must reconfigure the *Connection Settings* in Microsoft ActiveSync to make the required communication port available. Then use the Trimble Data Transfer utility directly.

Using Bluetooth to Connect a Trimble CU or TSC2 to an Office Computer

You can use Bluetooth wireless technology to establish a connection between a Trimble CU or TSC2 and an office computer, and then you can transfer files using Bluetooth and the Trimble Data Transfer utility or Microsoft ActiveSync.

To set up the connection:

- [Install and configure Bluetooth wireless technology](#)
- [Configure Microsoft ActiveSync technology to use Bluetooth wireless technology](#)
- [Configure the Trimble CU, and connect using ActiveSync and Bluetooth wireless technology](#)
- [Configure the Trimble TSC2, and connect using ActiveSync and Bluetooth wireless technology](#)

Installing and Configuring the Bluetooth software

Installing and configuring the software and drivers for the Bluetooth hardware will be different from one Bluetooth manufacturer to another. The following steps are generic and should apply to most Bluetooth devices.

1. Follow the Bluetooth manufacturer's instructions to install the software and drivers for the Bluetooth device.

If your office computer has integrated Bluetooth wireless, follow these steps:

- a. Select *Start / Programs / Software Setup*.
- b. Expand the *Hardware Enabling Drivers* tree structure. Make sure that *Bluetooth* is selected; clear all the others.
- c. Clear the *Software Applications* check box.
- d. Select *Next* to complete the installation.

If you have an external USB Bluetooth device (such as TDK Systems or DSE Bluetooth dongles manufactured by Cambridge Silicon Radio), use the CD and instructions provided.

2. During the installation process, you should be asked to connect the Bluetooth dongle. If you have not already done this, connect the dongle to the office computer now.
3. If prompted, reboot the system after you install the software.
4. Check the COM port assigned to the Bluetooth device:
 - a. Once you install the software, a Bluetooth icon appears in the System tray on the office computer. Right-click the Bluetooth icon.
 - b. Select *Advanced Configuration*. In the *Local Services* tab, note the COM port that is assigned to the *Bluetooth Serial Port* service. You must configure this COM port for use with Microsoft ActiveSync.

Alternatively, select *Start / Programs / My Bluetooth Places* and then select *My Device / My Bluetooth Serial Port / Properties*.

The Bluetooth device is now configured as a COM port on the office computer.

Note - You may need to be a local administrator to install the Bluetooth software.

Configuring Microsoft ActiveSync to use Bluetooth

1. Disconnect any devices that are communicating with the controller and the office computer.
2. Start the ActiveSync technology. On the office computer, select *Start / Programs / Microsoft ActiveSync*.
3. Configure the connection method. In Microsoft ActiveSync, select *File / Connection Settings*.
 - a. Select the *Allow serial cable or infrared connection to this COM port* check box.
 - b. Select the COM port number (for example COM7) noted earlier that was assigned to the Bluetooth dongle.

You only need to do this once to configure the connection settings. Subsequent connections start Microsoft ActiveSync automatically.

4. To close the *Connection Settings* dialog, click *OK*.

Configuring the Trimble CU and connecting with ActiveSync using Bluetooth.

The Bluetooth connection between the controller and the office computer is initiated on the controller:

1. On the controller tap [Start / Settings / Control Panel / Bluetooth Device Properties].
2. Tap the [Configuration] tab and then select the [Show all exposed profiles on inquiry] check box.

A normal scan finds all devices that are in the neighborhood. With an SDP service discovery, when the controller finds a Bluetooth device, the controller interrogates the device to find out what services that device supports.

3. Tap the [Scan Device] tab and then select the [Enable Bluetooth] check box.
4. To Scan for all available Bluetooth devices, tap [Scan Device].

Once the controller completes the scan, the Bluetooth services that were found appear in the [Untrusted] list on the left of the screen.

5. Highlight the Bluetooth device with the blue ActiveSync logo and the name of your office computer. To make the computer a trusted device, tap the --> softkey.
6. When the authentication message appears, tap [No]. When connecting a controller to an office computer, you do not need to authenticate the device.
7. To make the trusted device active, double-tap the device and then select [Active].
8. To disable authentication, double-tap the device and then clear the [Authenticate] option. This step is optional.
9. To close the Bluetooth manager, tap [OK].
10. To connect the controller to the office computer, tap [Start / Programs / Utilities / ActiveSync].

If the [No Partnerships] error appears, create a [partnership](#) using USB to connect the controller and the office computer. Then repeat step 10.

11. Set the connection method to the office computer to [Bluetooth]. Make sure that [Connect to] is set to the name of your office computer.
12. Tap [Connect]. The controller starts communicating with the office computer.
13. When prompted on the office computer, enter a Bluetooth PIN code to create a paired relationship. Enter a PIN that is easy to remember and then click OK.
You have 30 seconds to do this before the connection attempt times out.
14. When prompted on the controller, enter your PIN again and then tap [OK].

If you cleared the [Authenticate] option (step 8 above), you do not need to “pair” the two devices again. If you selected the [Authenticate] option, you are prompted each time you connect.

15. When prompted on the office computer, authorize the connection between the controller and the office computer. Tap [OK].
You have 30 seconds to do this before the connection attempt times out.

Tip - To avoid authorizing the connection each time, enable the *Always allow this device to access this service* check box during the final authentication process on the office computer.

16. The Microsoft ActiveSync technology starts and prompts you to set up a new partnership, unless one already exists. Follow the wizard to create a [partnership](#).

Once you successfully connect the controller to the office computer, you can use Trimble Data Transfer or the Microsoft ActiveSync technology to transfer files.

Configuring the Trimble TSC2 and connecting with ActiveSync using Bluetooth.

The Bluetooth connection between the controller and the office computer is initiated on the controller:

1. On the controller tap [Start / Settings / Connections / Bluetooth].
2. In the [Mode] tab, select the [Turn on Bluetooth] check box.
3. To Scan for all available Bluetooth devices, select the [Devices] tab, and then tap [New Partnership].

Once the controller completes the scan, the Bluetooth services that were found appear.

4. Highlight the Bluetooth device with the name of your office computer, and then tap [Next].
5. Ensure the [Activesync] service check box is selected and then tap [Finish].
6. When the authentication message appears, tap [No]. When connecting a controller to an office computer, you do not need to authenticate the device.
7. To close the Bluetooth manager, tap [OK].
8. To connect the controller to the office computer, tap [Start / Programs / ActiveSync].
9. Tap [Menu], and then tap [Options] and choose the data you want to sync to, and then tap [OK].
10. Tap [Menu], and then tap [Connect via Bluetooth].
11. When prompted on the office computer, enter a Bluetooth PIN code to create a paired relationship. Enter a PIN that is easy to remember and then click [OK].
You have 30 seconds to do this before the connection attempt times out.
12. When prompted on the controller, enter your PIN again and then tap [OK].

If you cleared the [Authenticate] option (step 6 above), you do not need to “pair” the two devices again. If you selected the [Authenticate] option, you are prompted each time you connect.

13. When prompted on the office computer, authorize the connection between the controller and the office computer. Tap [OK].
You have 30 seconds to do this before the connection attempt times out.

Tip - To avoid authorizing the connection each time, enable the *Always allow this device to access this service* check box during the final authentication process on the office computer.

14. The Microsoft ActiveSync technology starts and prompts you to set up a new partnership, unless one already exists. Follow the wizard to create a [partnership](#).

Once you successfully connect the controller to the office computer, you can use Trimble Data Transfer or the Microsoft ActiveSync technology to transfer files.

Using WiFi to Connect a TSC2 controller to an Office Computer

You can use WiFi to establish a connection between a TSC2 controller and an office computer, and then you can explore the Web using WiFi.

Note – The Trimble CU, and TSC2 controllers do not support file transfer using WiFi and the Microsoft ActiveSync technology.

Configuring WiFi

These instructions assume that you already have a WiFi/wireless network set up in your office. You may need to contact your network administrator for information such as Wireless Encryption Protocol (WEP) network keys.

1. Check that the WiFi radio is enabled:
 1. Select [Start / Programs / Wireless Client].
 2. To enable the radio, select [Tools / Enable Radio].
If the radio is already enabled, the menu option is [Disable Radio].
2. If your wireless network has WEP enabled, you are prompted to enter a [Network Key].
You may need to contact your network administrator for details of this key.
3. Once you are connected to the wireless network, you may be prompted for your network login information, for example, username, password, and domain. Enter this information as you do when connecting to your network.
4. If you can connect to the wireless network, but cannot access Network resources, select [Advanced / Network Troubleshooting] for general information about your connection. For advanced information, select [More Info].

The TSC2 controller is now connected to your network.

Using the Trimble Data Transfer Utility

Use the Trimble Data Transfer utility to transfer files between Trimble Survey Controller and the office computer.

To transfer files using Trimble Data Transfer:

1. To transfer files to Trimble Survey Controller, you must first connect the controller to the office computer using the Microsoft ActiveSync technology, for more information see [Connecting the controller to the office computer using the Microsoft ActiveSync technology](#).
2. On the office computer, start the Data Transfer utility.
3. Ensure that the Device setting in Data Transfer is set correctly, for example, **Trimble Survey Controller on ActiveSync** and select the **Connect** button to connect.
When the default device is set correctly, this connection process is automatic.
4. Select the *Receive* or *Send* tab as appropriate.
5. Select *Add*.
6. In the *Open* dialog, set the appropriate options for the file type, and select the file to transfer.
7. Select *Transfer All* to start the file transfer.

For more information on using Data Transfer, refer to the Data Transfer Help.

Using Microsoft Explorer with the Microsoft ActiveSync Technology Enabled

You can use the Microsoft Explorer and ActiveSync technology to move or copy files to or from the Trimble controller. Use the software to transfer files that do not require [conversion](#) by Data Transfer (for example, comma delimited (.csv) files). See the table below.

To transfer files to Trimble Survey Controller, you must first connect the controller to the office computer using the Microsoft ActiveSync technology. For more information, see [Connecting the controller to the office](#)

computer using [Microsoft ActiveSync](#).

When connected, from the Microsoft ActiveSync window:

1. Click **Explore** to move or copy files between the office computer and the Trimble controller for sharing information. Alternatively, use Windows Explorer to move or copy files.
2. Click **Tools** to backup and restore files.

For more information on using Microsoft ActiveSync technology to transfer files, refer to the Microsoft ActiveSync Help.

File Conversion

When data is transferred to and from the Trimble Survey Controller software, some files are converted for use in the Trimble software.

The following table lists the files that are used in the Trimble Survey Controller software and the file types they are converted to when transferred to and from Trimble office software.

PC	Controller	Description	Data Transfer	MS Explorer / ActiveSync
.dc	.job	Trimble Survey Controller job files	Y	N
.csv	.csv	Comma Delimited (CSV) files	Y	Y
.txt	.txt	Comma Delimited (TXT) files	Y	Y
.dtx	.dtm	Digital Terrain Model files	Y	N
.ttm	.ttm	Triangulated Terrain Model files	Y	Y
.fcl	.fal	Feature and Attribute Library files (TGO)	Y	N
.fxl	.fxl	Feature and Attribute Library files (TBC)	Y	Y
.ddf	.fal	Data Dictionary files	Y	N
.ggf	.ggf	Geoid Grid files	Y	Y
.cdg	.cdg	Combined Datum Grid files	Y	Y
.pjpg	.pjpg	Projection grid files	Y	N
.sgf	.sgf	Shift grid files	Y	N
.pgf	.pgf	UK National Grid files	Y	Y
.dxf	.dxf	Map files	Y	Y
.shp	.shp	ESRI map shape files	Y	Y
.ini	.dat	Antenna files	Y	N
.lng	.lng	Language files	Y	Y
.wav	.wav	Sound files	Y	Y
.dat	.dat	GPS data files	Y	Y
.t01 .dat	.t01	GPS data files	Y (.dat for TGO)	Y (.t01 for TBC)

.crd .inp .mos	.crd .inp .mos	GENIO road files	Y	Y
.xml	.xml	LandXML road files or XML Documents	Y	Y
.jxl	.jxl	JobXML files	Y	Y
.ixl	.ixl	Custom ASCII Import file definitions	N	Y
.xsl	.xsl	XSLT Custom ASCII Export Stylesheet files	Y	Y
.sss	.sss	XLST Custom Stakeout Stylesheet files	Y	Y
.mcd	.mcd	Measure Codes Database files	N	Y
.dc	.rxl	Trimble road file	Y	N
.rxl	.rxl	Alignment files	Y	Y
.txl	.txl	Tunnel files	Y	Y
.csd .csw	.csd	Coordinate System Database files	Y	N
.jpg	.jpg	Image files	Y	Y
.tsf	.tsf	Scan files	Y	Y

N = No. Use Data Transfer to convert the file.

When a .dc file is transferred to the Trimble Geomatics Office software, any GPS data files associated with that file are also transferred. Information about the .dc file format is available from the Trimble website (www.trimble.com). For more information, contact your local Trimble dealer.

Note - If a Trimble Geomatics Office project uses a geoid model, remember to also transfer the geoid file (or the subgridded part of it) when transferring the job into the Trimble Survey Controller software.

Transferring a Geodimeter (GDM) job file

To create a GDM Job on the controller, or on a computer using ASCII File Generator, see [Creating Custom ASCII Files](#). Custom ASCII File uses XSLT style sheets that you can modify as required to generate new formats.

To transfer a GDM .job file from a Trimble controller to an office computer, use the Data Transfer utility, as described [above](#).

When the *Open* dialog appears, select GDM Job files from the *Files of type* list.

The GDM job files transferred using this option contain the terrestrial observation data collected on the Trimble controller.

Note - When you transfer a Geodimeter job file, for example test.job, from a Trimble controller, the software generates two files:

- test.job (the backup of the Trimble Survey Controller job file)
- testGDM.job (the actual GDM .job file)

Special functionality when creating GDM job files

So that you can collect several user data items for a point in Trimble Survey Controller and then output the point attributes through a GDM job file as standard user label items, the following function is supported. While the GDM job file is being created from Trimble Survey Controller data, the point attributes are processed as follows. If you have assigned point attributes named 90 through 99 (GDM labels that can you can define), and assigned values to the attributes, then these attributes will automatically be output as labels 90= through 99=.

Similarly, if a point attribute is named 4, and it has a value assigned to it, then the attribute will be output as the point code (label 4=) instead of the original code assigned to the point.

Note - Before you can use this function, you must create a feature and attribute library that defines features with appropriately named attributes (for example, 4, and 90 through 99). You must also transfer this feature and attribute library to the Trimble Survey Controller and assign it to the Trimble Survey Controller job. A sample feature and attribute library is available on the Trimble Survey Controller CD in the [Trimble Survey Controller\Utilities] folder.

Transferring a Zeiss M5 file

To create a Zeiss M5 file on the controller, or on a computer using ASCII File Generator, see [Export custom format files](#). The M5 coordinates file that was created using Export custom format files lets you create files using the 3300 or the 3600 default markings. Export custom format files uses XSLT style sheets that you can modify as required to generate new formats.

To transfer a Zeiss M5 file from a Trimble controller to an office computer, use the Data Transfer utility, as described [above](#).

When the *Open* dialog appears, select M5 Files from the *Files of type* list.

The M5 files transferred using this option contain the terrestrial observation data collected on the controller. The M5 file also includes coordinates for observed points.

Transferring ESRI Shapefiles with the Data Transfer utility

To create ESRI Shapefiles on the controller, see [Exporting ESRI Shapefiles](#).

To create and transfer ESRI Shapefiles from a Trimble controller to an office computer, use the Data Transfer utility, as described [above](#).

When the *Open* dialog appears, select *ESRI Shapefiles* from the *Files of type* list, specify whether you require *Grid coordinates* (northing/easting/elevation) or *Lat/Long coordinates* (local latitude/longitude/height) and then select a destination folder.

The shapefiles, and all files linked using the file name attributes, are transferred to the specified folder. For every feature code in that job that contains attribute information, .shp, .shx, and .dbf files are created. The files are named '<job name>space<feature code name>'. Any points that do not have feature codes are saved in the <job name>.shp, <job name>.shx and <job name>.dbf files.

Note - The *ESRI shapefiles* option appears in the *Files of type* field only if the connected controller has the [High Accuracy GIS](#) option enabled.

AutoCAD Land Desktop software

Use the Trimble Link software to transfer data between the Trimble Survey Controller software and Autodesk AutoCAD Land Desktop software.

When job data is transferred from the Trimble Survey Controller software to the AutoCAD Land Desktop software, a .tic file is created.

Sending and Receiving ASCII Data Between External Devices

This section describes how to use the *Send data to another device* and *Receive data from another device* function in the Trimble Survey Controller software. Use these functions to transfer point names, point codes, and grid coordinates in ASCII format between the Trimble controllers and a variety of conventional instruments, data collectors, and office computers.

In addition, you can transfer ASCII files directly to the office computer using third-party download software, such as HyperTerminal.

Note - Only points with grid coordinates are transferred when you use the ASCII data transfer function. If the job does not have a projection and datum transformation specified, GPS points cannot be transferred. Furthermore, deleted points, and any points stored as polar vectors from a deleted point, cannot be transferred.

[Transferring ASCII data to and from an external device](#)

[Send data to another device](#)

[Receive data from another device](#)

Transferring ASCII Data to and from an external device

You can transfer ASCII data to and from an external device or office computer in the following formats:

- Trimble GDM (Area)
- Comma delimited (*.csv, *.txt)
- SDR33 coordinates
- SDR33 DC
- TDS CR5
- Topcon (FC-5)
- Topcon (GTS-7)
- Trimble DC v10.7
- Trimble DC v10.0
- SC Exchange
- Trimble Zeiss M5

The next sections describe how to connect a Trimble controller, and how to send and receive data to and from the Trimble Survey Controller software.

Send data to another device

Warning - When sending data to a device that does not include a units setting as part of its file, make sure that the Trimble Survey Controller file uses the units setting of that device.

If you are not sure whether the device file includes a units setting, set the Trimble Survey Controller file to the same units as the device.

To send ASCII data to an external device:

1. Select *Files / Import / Export / Send data to another device*.
2. Use the *File format* field to specify the type of file to send.

3. Set the transfer parameters:

- a. Set the *Controller port* field to the Trimble controller port you are using for the transfer.

Note - Set the controller port to Bluetooth to send Comma Delimited, Trimble DC v10.0, Trimble DC v10.70 and SC Exchange formats to another controller using Bluetooth. Before sending files using Bluetooth, you must configure the Bluetooth connection. For more information see, [Bluetooth configuration](#).

- b. Set the *Baud rate* and *Parity* fields to match the corresponding parameters on the device that you are communicating with.

Note - If the *File format* field is set to Comma Delimited (*.CSV, *.TXT), set the baud rate correctly on the external device. If appropriate, also set the flow control (xon/xoff).

- c. If you are transferring a SDR33 .dc file, and you want the Trimble Survey Controller software to include a checksum when the file is transferred, select *On* in the *Checksum* field.

Note - For the Trimble GDM (Area), SDR33, TDS CR5, Topcon (GTS-7), Topcon (FC-5), and Trimble Zeiss M5 output options, you must select the appropriate format on the external device.

Note - The Trimble Zeiss M5 output option uses the default Markings for the Trimble 3300 instrument in the coordinate file that is transferred. Markings refers to the layout of the 27 character field used for the point number and code details in the M5 format file. The Markings in the transferred file are as follow:

- ◇ Characters 1 - 11 are unused and are output as spaces.
- ◇ Characters 12 - 15 hold numeric point codes (right justified within these characters).
Any non-numeric characters in point codes are not output to the file.
- ◇ Characters 16 - 27 hold numeric point names assigned by the Trimble Survey Controller on export (right justified within these characters).

Make sure that the Markings settings on a 3300 instrument, and the P11 Markings on a 3600 instrument, are configured as above when transferring ASCII files to and from Trimble Survey Controller.

4. Set the file parameters:

- a. If the *File format* field is set to *SDR33 coordinates* or *TDS CR5* , the *Job name* field appears. Enter a name for the file that is created when the data is transferred.
- b. Set the *Point name* field to *Unchanged* or *Auto-generate*. *Unchanged* sends the point names as they appear on the Trimble controller. *Auto-generate* adds two extra fields:
 - ◇ Use the *Start point name* field to specify the name of the first point to be transferred.
 - ◇ Use the *Auto point step size* field to define the amount by which the *Start point* value is incremented or decremented when the Trimble Survey Controller software generates point names for subsequently transferred points.

Note - If the *File format* field is set to *TDS CR5* and the *Point name* field is set to *Unchanged*, a point will only be transferred if the point name is less than eight characters long and contains numeric characters only.
- c. Use the *Point code* field to specify what is sent to the external device selected in the *Code* field:
 - ◇ Select *Use point code* to send the point code.
 - ◇ Select *Use point name* to send the point name.

Note - If you have used long codes (up to 42 characters) in the Trimble Survey Controller software, and the file format you are transferring to does not support long codes, the codes will be shortened.
- d. If the *File format* field is set to *SDR33 coordinates* , there is an *Output notes* check box. Select this to output all user-entered notes with the point data. The notes are output in *SDR33 record 13NM* format.
- e. If the *Comma Delimited (*.CSV, *.TXT)* option is selected, you can specify the format of the data that is received. Five fields appear: *Point name*, *Point code*, *Northing*, *Easting*, and *Elevation* .
Using the options provided, select a position for each field. Select *Unused* if a particular value is not present in the file being received. For example:

Point name Field 1

Point code Unused

Northing Field 2

Easting Field 3

Elevation Field 4

- 5. Transfer the files:
 - a. When the format details are complete, tap *Send*.
 - b. If you are sending points (not a .dc file), the *Select points* screen appears. Select the points to send.
The procedure is similar to that to create a *Stake out points* list. For more information, see [Stakeout points](#).
 - c. The Trimble Survey Controller software prompts you to initiate receiving on the instrument that you are sending data to. For more information about receiving data, refer to the manual for the receiving device.

When the other device is ready to receive, tap *Yes* to send the data. The data is transferred.

Notes

- When sending ASCII data from a Trimble controller to an external device, it is important to follow on-screen instructions. The cable must not be connected until you are prompted to do so. If you connect the cables at the wrong time, the transfer will fail.
- In an SC Exchange .dc file, all observations are reduced to WGS84 positions and grid positions (coordinates). Use this file format to transfer .dc files between different versions of the Trimble Survey Controller software.
- Trimble Survey Controller outputs the latest version SC Exchange DC file that the software knows about.
When importing SC Exchange files, Trimble Survey Controller reads all records it knows about. If importing a new version SC Exchange file into an older version of Trimble Survey Controller, the software does not read new records that it does not understand.
- The Trimble GDM (Area) and Trimble Zeiss M5 formats created using the Trimble Survey Controller *Send data to another device* option are designed for data transfer to terrestrial instruments. The file format used is different from the GDM job and M5 files downloaded using Data Transfer.

Receive data from another device

Warning - When receiving data from a device that does not include a units setting as part of its file, make sure that the Trimble Survey Controller file uses the units setting of that device. If you are not sure whether the device file includes a units setting, set the Trimble Survey Controller file to the same units as the device.

To receive ASCII data from an external device:

1. Select *Files / Import / Export / Receive data from another device*.
2. Use the *File format* field to specify the type of file to receive.
3. Set the transfer parameters:
 - a. In the *Port details / Controller port* field, select the Trimble Controller port used for the transfer.

Note - Set the controller port to Bluetooth to receive Comma Delimited, Trimble DC v10.0, Trimble DC v10.70 and SC Exchange formats to another controller using Bluetooth. Before receiving files using Bluetooth, you must configure the Bluetooth connection. For more information see, [Bluetooth configuration](#).
 - b. Set the *Baud rate* and *Parity* fields to match the corresponding parameters on the device that the Trimble Survey Controller software is communicating with.
Note - If the *File format* field is set to Comma Delimited (*.CSV, *.TXT), set the baud rate correctly on the external device. If appropriate, also set the flow control (xon/xoff).

If you are transferring a SDR33 .dc file, and you want the Trimble Survey Controller software to validate the checksum when the file is transferred, select *On* in the *Checksum* field.

4. The option in the *File format* field determines what you do next:

- ◆ If you select one of the following options, you must choose the appropriate output format on the external device:
 - ◇ Comma delimited (*.csv, *.txt)
 - ◇ SDR33 coordinates
 - ◇ SDR33 DC
 - ◇ TDS CR5
 - ◇ Topcon (FC-5)
 - ◇ Topcon (GTS-7)
 - ◇ Trimble DC v10.7
 - ◇ Trimble DC v10.0
 - ◇ SC Exchange
 - ◇ Trimble Zeiss M5

Use the *Point name* field to define how the point names in the data are received.

Note - In the case of the Trimble Zeiss M5 format the Markings (organization of the 27 character point number and code field) must conform to the following definitions:

- ◇ Characters 12 - 15 holding the point code
- ◇ Characters 16 - 27 holding the point name

Note - Trimble Survey Controller point names have a maximum of 16 characters, but some points received from other devices can exceed this. If point names have 16 characters or more, choose either Truncate left or Truncate right.

- ◆ If the Comma Delimited (*.CSV, *.TXT) option is selected, you can specify the format of the data that is received. Five fields appear: *Point name*, *Point code*, *Northing*, *Easting*, and *Elevation*.

Using the options provided, select a position for each field. Select *Unused* if a particular value is not present in the file being received. For example:

Point name Field 1

Point code Unused

Northing Field 2

Easting Field 3

Elevation Field 4

5. Store the files:

- a. When the format details are complete and the external device is ready to send, connect the cables and tap *Receive*.

The Trimble Survey Controller software prompts you to initiate sending on the external device. For more information about sending data, refer to the manual for the sending device.

When sending is initiated, the Trimble Survey Controller software starts to receive data, and a progress bar appears.

When the transfer is complete, the Trimble Survey Controller software automatically terminates the operation and saves the received data.

- b. If it is clear that the transfer is complete but the operation has not been terminated, tap *Esc*. The following message appears:

Transmission interrupted. What would you like to do now? Do one of the following:

- ◆ Tap *Continue* to return the Trimble Survey Controller software to receive mode.
- ◆ Tap *Finish* to terminate the operation and save any received data to the current job.
- ◆ Tap *Cancel* to terminate the operation and discard any received data.

Note - When receiving ASCII data from an external device to a Trimble controller, you must follow the on-screen instructions. Do not connect the cable until you are prompted to do so, otherwise the transfer will fail.

Import and Export Fixed Format Files

Use these functions to:

- Import a fixed format file and convert it to a new Trimble job file
- Export a fixed format file from a Trimble job file and create a new file

The following formats are available:

- Comma delimited (*.csv, *.txt)
- SDR33 DC
- Trimble DC v10.7
- Trimble DC v10.0
- SC Exchange
- Trimble JobXML
- [ESRI Shapefiles](#) (available only with the [High Accuracy GIS](#) option)

When you create files using *Export fixed format files* or *Export custom format files*, you can save the new format files to an existing folder on the controller, or create a new one. The default folder is the [Export] folder below the current [project folder](#). If you change the project folder, the system creates an export folder under the new project folder, and gives it the same name as the previous export folder.

Tap  to select an existing folder or create a new one.

If the Comma Delimited (*.CSV, *.TXT) option is selected, you can specify the format of the data that is received. Five fields appear: *Point name*, *Point code*, *Northing*, *Easting*, and *Elevation*.

Using the options provided, select a position for each field. Select *Unused* if a particular value is not present in the file being received. For example:

Point name Field 1

Point code Unused

Northing Field 2

Easting Field 3

Elevation Field 4

Notes

- Importing from a JobXML file to a Trimble job file is mainly used to transfer the coordinate system definition and design information. A JobXML file generated from a Trimble job contains all the raw data in the FieldBook section, and "the best" coordinate for each point from the job in the Reductions section. Only the data from the Reductions section is read into the new Trimble job file, raw observations are not imported.
- In an SC Exchange .dc file, all observations are reduced to WGS84 positions and grid positions (coordinates). Use this file format to transfer .dc files between different versions of the Trimble Survey Controller software running on the Trimble CU and TSC2 controllers.
- The Trimble Survey Controller software outputs the latest version SC Exchange DC file that the software knows about.
When importing SC Exchange files, the Trimble Survey Controller software reads all records it knows about. If importing a new version SC Exchange file into an older version of the Trimble Survey Controller software, the software does not read new records that it does not understand.
- The Trimble Survey Controller software remembers where to export files only up to two folders below the project folder. If you send export files to subfolders deeper than that, you must set the folder each time you export a file.

To learn more about customizing your own ASCII format, see [Export custom format files](#).

Exporting ESRI Shapefiles

To create and transfer ESRI Shapefiles from a Trimble controller to an office computer, using the Data Transfer utility, see [Transferring ESRI Shapefiles](#).

Note - This option cannot be used to transfer shapefiles that were created on the controller. To transfer shapefiles created on the controller to the office computer use Microsoft ActiveSync.

To create ESRI Shapefiles on the controller:

1. Select *Files / Import / Export / Export fixed format files*.
2. Set the *File format* type to *ESRI Shapefiles*.

Note - The *ESRI Shapefiles* option only appears in the *Files of type* field if the connected controller has the High Accuracy GIS option enabled.

3. Set the file name, set the *Coordinates* to either *Grid* (northing/easting/elevation) or *Lat/Long coordinates* (local latitude/longitude/height), and then tap *Accept*.

The shapefiles are transferred to the folder specified. A *.shp, *.shx and *.dbf file is created for every feature code in the job that contains attribute information. The files are named '<job name>space <feature code name>'. All points that do not have feature codes are saved in the <job name>.shp, <job name>.shx and<job name>.dbf files.

Export Custom Format Files

Use this menu to create custom ASCII files on the controller while in the field. Use the predefined formats or create your own custom formats. With custom formats, you can create files of almost any description. Use these files to check data in the field, or to produce reports, which you can e-mail from the field to your client or to the office for further processing with the office software.

The predefined ASCII export formats available on the controller include:

- Check shot report
- Comma delimited with attributes
- GDM area
- GDM job
- M5 coordinates
- Monitoring report
- Road-line-arc stakeout report
- Stakeout report
- Survey report
- Traverse adjustment report
- Traverse deltas report

These Custom Export ASCII formats are defined by the XSLT style sheet (*.xsl) definition files. They can be located in both the language folder and in [Trimble data]. Translated Custom Export stylesheet files are typically stored in the appropriate language folder.

You can modify a predefined format to meet your specific requirements, or use it as a template to create a completely new custom ASCII export format.

In addition, the following predefined formats are available on the Trimble Survey Controller CD. To copy the files to the controller, use Trimble Data Transfer or the Microsoft ActiveSync technology.

- CMM coordinates
- CMM elevations
- KOF
- SDMS

To create a custom ASCII file using a predefined XSLT style sheet:

1. Open the job that contains the data to export.
2. From the main menu, select *Files / Import/Export / Export custom format files*.
3. In the *File format* field, specify the type of file to create.
4. Enter a filename.

By default, the *File name* field shows the name of the current job. The filename extension is defined in the XSLT style sheet. Change the file name and extension as required.

5. If more fields are displayed, complete them.

You can use the XSLT style sheets to generate files and reports based on parameters that you define. For example, when generating a Stakeout report, the *Stakeout horizontal tolerance* and the *Stakeout vertical tolerance* fields define acceptable stakeout tolerances. When generating the report you can stipulate the tolerances, then any stakeout delta greater than the defined tolerances appears in color in the generated report.

6. To automatically view the file after you create it, select the *View created file* check box.
7. To create the file, tap *Accept*.

Note - When the selected XSLT style sheet is applied to create the custom export file, the processing is all carried out in the program memory available on the device. If there is not enough memory to enable the creation of the export file, an error message will be displayed and no export file will be created.

The maximum program memory the controller operating system has available for this process is 32 MB.

Four factors will affect whether the export file can be created

1. The amount of program memory available to the device.
2. The size of the job being exported.
3. The complexity of the style sheet being used to create the export file.
4. The amount of data being written to the export file.

If it is not possible to create the export file on the controller, download the job as a JobXML file to a computer.

To create the export file from the downloaded JobXML file using the same XSLT style sheet, use the ASCII File Generator utility program (available on the Trimble Survey Controller CD).

Creating XSLT Style Sheets to define Custom ASCII Formats

You can use any text editor, such as Microsoft Notepad, to make minor changes to the predefined formats. However, to create a completely new custom ASCII format, you need some basic programming knowledge.

You cannot easily modify or create a style sheet on the controller. To successfully develop new style sheet definitions, work on an office computer using a suitable XML file utility program.

The predefined formats on the controller are available on the CD. You can edit them and then transfer them to the controller using Microsoft ActiveSync technology. To retain the existing formats, save the modified

formats with a new XSLT filename.

To develop your own XSLT style sheets, you need:

- An office computer.
- Basic programming skills.
- An XML file utility program with good debugging facilities.
- The JobXML file schema definition that provides the details of the JobXML format required to create a new XSLT style sheet.
- A Trimble Survey Controller Job or JobXML file that contains the source data.

The predefined XSLT style sheets and JobXML file schema are available under the *[Trimble Survey Controller\Utilities]* folder on the Trimble Survey Controller CD.

You can install the ASCII File Generator utility from the Trimble Survey Controller CD. For information on using this utility, refer to the ASCII File Generator Help.

The basic steps are:

1. Source a Job file or JobXML file from your Trimble controller. Use one of the following methods:
 - Transfer a Job file from the controller using Microsoft ActiveSync technology or Data Transfer and then use the job file directly with the ASCII File Generator.
 - Transfer a Job file from the controller using Microsoft ActiveSync technology or Data Transfer and then use the ASCII File Generator to create a JobXML file.
 - Create a JobXML file on the controller. From the *Import/Export / Create ASCII file* menu, set the *File format* field to *Trimble JobXML*. Transfer the JobXML file using Microsoft ActiveSync technology.
 - Create and transfer a JobXML file using Data Transfer. Make sure that the *Files of type* field is set to *JobXML Files*.
2. Create the new format using a predefined XSLT style sheet as a starting point and the JobXML schema as a guide.
3. To create the new custom ASCII file on the office computer, use the ASCII File Generator utility to apply the XSLT style sheet to the Trimble Job or JobXML file.
4. To create the custom ASCII files on the controller, copy the file to the *[Trimble data]* folder on the controller using Microsoft ActiveSync technology.

Notes

- XSLT style sheet definition files are XML format files.
- The predefined style sheet definitions are provided in English. Modify these files as required to your own language.
- During installation, new versions of the predefined ASCII import and export formats are installed to the controller. If you have created new custom import or export formats or modified and **renamed** the existing formats then these files are now reinstalled to the controller during the *Transfer Downloaded Trimble Files* step of the upgrade process.
If you modified the predefined formats and saved them with the same name, they will be replaced when you upgrade the controller. The downloaded files still exist on your office computer. If you

create new formats, or customize the predefined formats Trimble recommends you save the files with a new name. Use the Trimble Data Transfer utility or Microsoft ActiveSync technology to transfer these files back onto the controller once the upgrade is complete.

- Style sheets must be created according to the XSLT standards as defined by the World Wide Web Consortium (W3C). For details, go to <http://www.w3.org>.
- The Trimble JobXML file schema definition provides details of the JobXML file format.

Import Custom Format Files

Use this menu to import custom ASCII files into your current job. You can use the predefined formats or create your own custom format to import fixed-width or delimited ASCII files. You can import the following data using this option:

- Point name
- Code
- Description 1 and Description 2
- Notes attached to points
- Grid coordinates
- WGS84 geographic coordinates (degrees minutes and seconds, or decimal degrees)
To be successfully imported, points must have a height.
- Local geographic coordinates (degrees minutes and seconds, or decimal degrees)
To be successfully imported, points must have a height
- Line definitions
Before you import, line start and end points must exist in the database.

Line definitions include the following information: start point name, end point name, start station, station interval, azimuth, and length.

The predefined ASCII import formats available in the controller include:

- CSV Grid points E-N
Point Name, Easting, Northing, Elevation, Code
- CSV Grid points N-E
Point Name, Northing, Easting, Elevation, Code
- CSV Lines
Start Point Name, End Point Name, Start Station, Station Interval
- CSV WGS-84 Lat-long points
Point Name, Latitude, Longitude Height, Code

These Custom Import ASCII formats are defined by .ixl import definition files that are stored in the [Trimble data] folder.

To import an ASCII file using a predefined file format:

1. Transfer the file to be imported into the Trimble Data folder on your controller.
2. Open or create the job that you want to import the data into.

3. From the main menu, select *Files/ Import/Export / Import custom format files*.
4. In the *File format* field, specify the type of file to import.
5. In the *File name* field, select the file to import. All files in Trimble Data with the file extension specified in the format file (by default CSV) appear in the list.
6. If you are importing points, select or clear, as required, the *Import points as control* check box to specify if the imported points should be control points.
7. To import the file, tap *Accept*.

After import, a summary box shows how many items were imported and how many were discarded.

Creating custom ASCII import format files

Custom ASCII import format files are stored on the controller in the [Trimble data] folder, with the extension *.ixl. You can make simple edits to existing format files on the controller using Microsoft Pocket Word software. If you have majors edits or you want to create new format files, use a text editor on a desktop computer. Use ActiveSync technology to transfer the new or edited format files to the [Trimble data] folder on the controller.

For information on how to create your own import formats, refer to the Import Custom Format Files document available on the Trimble Survey Controller CD in the [Trimble Survey Controller\Utilities\Import Definitions] folder.

Email

Use this menu to send a message and/or file(s) from your controller to another computer.

To send a message or a file you must:

- [Configure an Internet dial profile](#)
- Configure the email settings

Once the dial profile settings and the email settings are configured, you are ready to [send an email](#).

To configure email:

1. Select *Files / Import / Export / Email*.
2. Tap *Config*.
3. Select or create a new *Dial profile*.
4. If you typically send your email to the same address, enter the address in *To address (default)*. This step is optional.
5. To inform the recipient of your email where the email came from, enter your address in *From address*.
6. If you typically send the same email message, enter a *Message (default)*. This step is optional.
7. If you want to change the file extension for zipped files, enter a new *Zipped file extension*.

Some email servers remove attached files with .zip file extensions. Some email servers also inspect the files to ensure the file extension matches the file type, and remove the file if it doesn't match.

If you know that the email server removes some file types, change the extension to a file type that will not be removed.

8. Configure the SMTP settings.

You only need to configure the SMTP settings the first time, or when they change.

9. Tap *Accept*.

Email configurations are saved in a file called [EmailConfig.xml] in the [Trimble data] folder. If you are familiar with XML, you can modify this file using office software. You can also copy the file to another controller. If you upgrade the controller to a newer version of the Trimble Survey Controller software, and upgrade the files on the controller, the file [EmailConfig.xml] will be reinstalled to the controller.

[EmailConfig.xml] contains the following information:

- Dial profile name
- Zipped file extension
- Recipient and Sender address
- SMPT server address and port
- Authentication required? True/false
 - ◆ If true, SMPT user name and SMPT password.
The password saved in [EmailConfig.xml] is encrypted, and **cannot** be edited.
- POP before SMPT? True/false
 - ◆ If true, POP server name, and POP server port
- Use SMPT authentication settings? True/false
 - ◆ If false, POP username, and POP password.
The password saved in [EmailConfig.xml] is encrypted, and **cannot** be edited.

Simple Mail Transfer Protocol (SMTP) and Post Office Protocol (POP)

SMTP is a protocol used to send messages from one server (your controller) to another.
POP is the protocol used to retrieve email from a server and download it to your computer.

Configure the SMTP and POP as required by your Internet Service Provider (ISP).

POP before SMTP

Some mail servers are set to POP before SMTP as a security measure to prevent SPAM. The mail server collects your IP address when you authenticate yourself with the POP server, and then allows SMTP to send your message.

If your ISP requires POP before SMTP, you must enable this checkbox and configure the POP settings.

Note - You cannot receive emails on your controller.

To send a file from the controller to another computer:

1. Select *Files / Import / Export / Email*.
2. To enter the address to send the email to, do one of the following:
 - ◆ Enter the address.
 - ◆ Enter the name associated with the address.
The Trimble Survey Controller software automatically completes the address for you.
 - ◆ Tap the arrow on the *To* field and then select an address from the [Email directory](#).
- Tip** - Enter a *To address (default)* to automatically set the *To* address.
3. Enter a subject, and a message. This step is optional.
4. Tap *Attach*, select one or more files to send and then tap *OK*.

Tip - To select more than one file, press and hold the [Ctrl] key as you tap the files.

5. Tap *Send*.

If you are already connected to the Internet, the email is sent.

Otherwise, an Internet connection is established using the Dial profile specified in the email configuration, the email is sent and you are then disconnected from the Internet.

Notes

- If you are already connected to the Internet, you can use this existing connection - you do not need to create a new connection.
- You can connect a TSC2 controller to the Internet using WiFi. For more information, see [Using WiFi to Connect a TSC2 controller to an Office Computer](#).
- Files saved in [Trimble data] and all subfolders under [Trimble data] can be emailed.
To email files not saved under [Trimble data], use File Explorer to copy or move the files to the [Trimble data] folder.
- You can send an email to only **one** recipient at a time.
- A file named *SentEmails.log* is saved to the [Trimble data] folder. The log file records the following information:
 - ◆ To address
 - ◆ Subject
 - ◆ Message
 - ◆ Date and time
 - ◆ Zip attachment name, and the names of the files included in the zip file
- You may not be able to access your usual email system. For example, you cannot use an SMTP server that requires an SSL connection.
- You cannot receive emails.

Email directory

An email directory contains a list of your contacts.

To create an email directory:

1. Select *Files / Import / Export / Email* and then tap *Next*.
2. Tap the arrow on the *To* field, and then tap *New*.

3. Enter the *Name* and the *Email address*, and then tap *Accept*.

Email addresses are saved in a file called [Email.xml] in the [Trimble data] folder. If you are familiar with XML, you can modify this file using office software. You can also copy the file to another controller. If you upgrade the controller to a newer version of the Trimble Survey Controller software, and upgrade the files on the controller, the file [Email.xml] will be reinstalled to the controller.

Configuration details required

The following information is required to configure the controller to send email messages. You can obtain this information from your Internet Service Provider or Mobile Network Provider.

Note - The Trimble Survey Controller software does not support SMTP connections that require a SSL connection.

SMTP Settings

- ◆ Server name
- ◆ Server port
- ◆ Username
- ◆ Password

POP Settings

You only need to configure the POP settings if your ISP requires POP before SMTP.

- ◆ Server name
- ◆ Server port
- ◆ Username
- ◆ Password

If you cannot use your usual email account, you can use a free service such as Yahoo! Mail. By enabling the [Yahoo! Mail Plus] service on your account, you will have access to an SMTP server that you can use with the Trimble Survey Controller software.

For example, if you registered an account with the name `trimblesurveyor007@yahoo.com` and enable the [Yahoo! Mail Plus] service (from the *Options* menu on the web interface to your Yahoo account), you would then use the following SMTP settings:

Server name	smtp.mail.yahoo.com
Server port	587
Username	trimblesurveyor007
Password	<Yahoo! Account password>

The Yahoo! SMTP server does not require POP before SMTP.

Note - The information above regarding the use of Yahoo! Mail is correct at the time of publication.

Sending attachments

When you send email through the Trimble Survey Controller, Trimble recommends that you send only a small number of files with each message. That is, send several small messages rather than a single large one. This is particularly important if you use a mobile internet connection, for example, a GPRS internet connection.

While the message is being sent, the system shows you the estimated time that it will take to send it, and the transfer rate.

Note - The time estimate can be inaccurate because the data transfer rate to your internet provider may vary while the email is being sent. Typically, the speed increases at first and then decreases.

To reduce the time that it takes to send a message, and to minimize your costs (if you pay per kilobyte), the Trimble Survey Controller software compresses all of the attached files into a single ZIP file.

Typically, a GPRS connection transfers approximately 2.5 KB per second on a mobile network under load. Using this figure, an estimate of the time to transfer messages of various sizes is shown below:

Message size (KB)	Transfer time (minutes)
100	0.7
200	1.4
400	2.8
500	3.5
750	5.0
1000	7.0

Note - Because the transfer rate often slows over time, a larger file (for example, 1000 KB) may take significantly longer to send than is shown above.

If you use a faster connection, for example, EDGE, 1xRTT or 802.11B/WiFi on the TSC2 controller, the transfer times are shorter.

Database Search Rules

Database Search Rules

This topic explains the database search rules relevant to the Trimble Survey Controller database.

- [Dynamic Database](#)
- [Search Rules](#)
 - ◆ [order in the database](#)
 - ◆ [search class](#)
- [Exceptions to the search rules](#)
- [Linked files and their Search Rules](#)
- [Finding the best point in the database](#)
- [The Overwriting rules](#)
- [Store another does not change the best point](#)
- [Assigning control class to a point](#)
- [Using low class points as backsights](#)

Note - If your job does not contain points of the same name, then the Search rules are not used.

Dynamic Database

The Trimble Survey Controller software includes a dynamic database. This stores networks of connected vectors during RTK and conventional surveys, making the positions of some points dependent on the positions of others. If you change the coordinates of a point that has dependent vectors (for example, an instrument station, a backsight point, or a GPS base station), this affects the coordinates of all points that depend on it.

Note - Editing the name of a point that has dependent vectors can also affect the coordinates of points that depend on it. If you change the point name, the following could occur:

- positions of other points could become null
- if another point with a matching name exists, that one could be used to coordinate the dependent vectors

The Trimble Survey Controller software uses database search rules to resolve the coordinates of dependent points, based on the new coordinates for a point they depend on. If the coordinates of a point with dependent points move by a certain amount, the dependent points are shifted by the same amount.

When two points of the same name exist, the Trimble Survey Controller software uses search rules to determine the best point.

Search Rules

The Trimble Survey Controller software lets multiple points with the same point name (point ID) exist in the same job.

To distinguish between points of the same name and to decide how these points are to be used, the Trimble Survey Controller software applies a set of search rules. When you ask for the coordinates of a point in order to perform a function or calculation, these search rules examine the database according to:

- the order in which the point records were written to the database
- the classification (search class) given to each point

Order in the Database

A database search starts at the beginning of the job database and works down to the end of the job, looking for a point with the specified name.

The Trimble Survey Controller software finds the first occurrence of a point of that name. It then searches the rest of the database for points of the same name.

Note - The database search changed for version 7.50 and later of the Trimble Survey Controller software. Previously the software searched from the end of the job database and worked up.

The rules generally followed by the software are:

- ◆ If two or more points have the same class and the same name, it uses the first point.
- ◆ If two or more points have the same name but different classes, it uses the point of higher class, even if this is not the first occurrence of the point.
- ◆ If two or more points (one from the job database and one from an attached linked file) have the same name, the software uses the point in the job database, regardless of the classification of the point in the linked file. For more information see, [Linked files and their Search Rules](#). There is one exception to this rule. You can now add points to a stakeout list from the linked file using the *Select from file* option, and the point from the linked file will be used even when the point already exists in the current job.

Search Class

The Trimble Survey Controller software gives most **Coordinates** and **Observations** a classification. It uses this classification to determine the relative importance of points and observations stored in the job database.

Coordinates have priority over Observations. If a Coordinate and an Observation of the same name have the same class, the Coordinate will be used regardless of its order in the database.

The **Coordinate Classes** are arranged in a descending hierarchy, as follows:

- ◆ Control - (the highest class) can only be set when a point is keyed in or transferred.
- ◆ Averaged - is given to grid positions stored as a result of an average position computation.
- ◆ Adjusted - is given to points that are adjusted in a traverse computation.
- ◆ Normal - is given to keyed-in and copied points.
- ◆ Construction - is given to all points measured using Fastfix, which are typically used in the computation of another point.

- ◆ Deleted - is given to points that have been overwritten, where the original point had the same (or a lower) search class than the new point. Deleted points are not displayed in point lists and they are not used in calculations. However, they do remain in the database.

Control class

Control class is used in preference to other classes. It can only be set by you. Use control class for points that you want to use in preference to points of the same name in the same job database. For more information, see [Assigning control class to a point](#).

Note - You cannot overwrite a control class point with a measured point, or use a control class point in an average position computation.

The **Observation Classes** are arranged in a descending hierarchy, as follows:

- ◆ Mean Turned Angle (MTA)
- ◆ Normal
- ◆ Backsight
- ◆ Construction
- ◆ Stakeout
- ◆ Check
- ◆ Deleted

Deleted observations are not displayed in point lists and they are not used in calculations. However, they do remain in the database.

Example

If a point named "1000" is entered as the start point when calculating a from-a-baseline offset, the Trimble Survey Controller software searches for the first occurrence of point "1000". It then searches the rest of the database for any point named "1000", under the following rules:

- ◆ If no other point of this name is found, it uses the one it has to calculate the offset.
- ◆ If another point "1000" is found, the software compares the classes of the two points. It uses the point "1000" that has the highest classification. Remember that a Coordinate class point (for example, keyed-in) is higher than an Observation class point. For example, if both points were keyed in, one was given a normal classification and the other a control classification, Trimble Survey Controller uses the control class point to calculate the offset, regardless of which record the search finds first. If one point was keyed in and one was observed, Trimble Survey Controller uses the keyed-in point.
- ◆ If the points are of the same class, Trimble Survey Controller uses the first one. For example, if both points named "1000" were keyed in, and both were given a normal classification, the first one is used.

Exceptions to the search rules

Normal search rules are not used in the following situations:

Exceptions to the search rules for GPS surveys:

- **In a GPS calibration**

Calibration searches for the highest class point stored as grid coordinates. This grid point is used as one of a pair of calibration points. The Trimble Survey Controller software then searches for the highest class GPS point stored as WGS84 coordinates or as a WGS84 vector. This point is used as the GPS part of the point pair.

- **When starting an RTK rover**

When you start a rover survey, if the broadcast base point is called, for example, "BASE001", choosing *Start survey* causes the Trimble Survey Controller software to search for the highest class GPS (WGS-84) point of that name. If no GPS point with the name "BASE001" exists, but "BASE001" exists with grid or local coordinates, the Trimble Survey Controller software converts the grid or local coordinates of the point into a GPS (WGS-84) point. It uses the projection, datum transformation, and current calibration to calculate the point. It is then stored, as "BASE001", with WGS-84 coordinates and is given a check class classification so that the original grid or local coordinates will still be used in calculations.

Note - The WGS-84 coordinates of the base point in the Trimble Survey Controller database are the coordinates from which GPS vectors are solved.

If there is no base point in the database, the position broadcast by the base receiver is stored as a normal class point and it is used as the base coordinates.

Exceptions to the search rules for conventional surveys:

- **F1 or F2 from one station setup and an MTA from another station setup**

If you observe a point on more than one face, an F1 observation and an F2 observation are combined to create an MTA record. In this situation, the MTA is used to coordinate the point. However, if there is an observation to a point on F1 or F2 only, from an earlier station setup, and later a station setup (that could be at the same station as the first) to that same point creates a new MTA, then the MTA is deemed to be of the same class as the earlier F1 or F2 observation. In this situation, the order in the database rule is invoked, and the first point in the database is deemed the best point.

- **Observations that coordinate a point are better than those that do not**

An angles and distance observation that coordinates the point, is better than an angles-only observation that does not coordinate a point. This rule applies even when the angles-only observation is earlier in the database, and is of a higher class, for example, an MTA.

Linked files and their Search Rules

Comma Delimited (*.csv or *.txt) files or Trimble Survey Controller (job) files can be linked to the current Trimble Survey Controller job to access external data. For more information, see [Linked files](#).

The Trimble Survey Controller search rules do not operate across linked files. Points in the current job are **always** used in preference to a point of the same name in the linked file, regardless of the classification. For example, if point 1000 in the current job has an As-staked classification, and point 1000 in a linked job file has a Normal coordinate classification, then the search rules will select the As-staked class point in preference to the Normal class point.

If both points were in the current job, then the search rules would select the Normal class point.

Note - You can add points to the stakeout list using the *Select from file* option even if the point in the linked file already exists in the current job. When a point of the same name exists in the current job, this is the only way that you can stake a point from a linked file.

When points of the same name exist in a single CSV file, the Trimble Survey Controller software uses the first point.

When points of the same name exist in multiple CSV files, the Trimble Survey Controller software uses the point in the first CSV file. The first CSV file is the first one in the file selection list. To change the order of the CSV files, tap the tabs at the top of the file selection screen. If you change the order of the CSV files, this may change the order in which files are selected.

When you accept a CSV file selection, and you then go back and select more CSV files, all subsequent files are appended to the initial selection, using the rules. This assumes that the original selection is not altered.

Trimble recommends that you do not use multiple CSV files that contain points of the same name.

Finding the best point in the database

To find the point with the highest classification, use the *Point manager*. In the *Point manager*, the highest class point always appears at the first level in the tree structure. If there is more than one point of the same name, the tree structure has a second level, which contains all points of the same name. The point with the highest classification appears at the top, followed by the other points of the same name, in the order in which they were observed.

Duplicate points and overwriting

Duplicate point tolerances compare the coordinates of a point to be stored with a point of the same name that already exists in the database. If the coordinates are outside the duplicate point tolerances defined in the survey style, the *Duplicate point out of tolerance* dialog appears. Select *Overwrite* to store the new point and delete all existing points of the same class or below.

Of the options displayed, *Overwrite* and *Average* are the only two options that might result in a point being 'promoted' - thus changing the coordinates for the best point.

Note - This warning only appears if the new point is out of tolerance with the original point. If you have changed the tolerance values, the message may not appear. For more information see, [Duplicate point tolerance](#).

In a conventional survey, observations from one station setup to the same point are combined to create an MTA record. You do not see the "duplicate point out of tolerance" warning.

If you store a face 2 observation to a point that already has a face 1 observation, the face 2 observation is checked to see if it is within tolerance of the face 1 observation and then stored. For more information about face 1 and face 2 observations, see [Measuring a point in two faces](#).

Warning - The duplicate point warning could indicate that you are about to overwrite a point that has dependent vectors. If you continue, the coordinates of the dependent vectors could change.

The Overwrite rules

Overwrite deletes points, and results in a change to the coordinates of the best point.

Note - Deleted points remain in the database and have a search class of Deleted. For more information, see [Search Class](#).

If the *Overwrite* option does not appear in the Trimble Survey Controller software, this means that an overwrite would not result in changes to the coordinates of the best point.

General Observation and Coordinate overwrite rules:

- ◆ Observations can overwrite and therefore delete Observations.
- ◆ Coordinates can overwrite and therefore delete Coordinates.
- ◆ Observations cannot overwrite Coordinates.
- ◆ Coordinates cannot overwrite Observations.

One exception to these rules is when a Rotate, Scale or Translation is performed. When one of these transformations is applied, the original observations are deleted and replaced by the translated points.

That does not mean that all Observations can overwrite all other Observations of the same name, and all Coordinates can overwrite all Coordinates of the same name. The [Search Class](#) rules still apply.

Some Examples

- ◆ If you measure a point with a name that already exists in the database, you can choose to overwrite it when you store the new one. All previous Observations of the same name, and with the same or a lower search class, are deleted.
If a point stored as a Coordinate existed, then overwrite would not have been an option, because overwriting the observations would not have changed the best point.
- ◆ If you key in a point with a name that already exists in the database, you can choose to overwrite it when you store the new one. All previous points stored as Coordinates, of the same name, and with the same or a lower search class, are deleted.
Points of the same name stored as Observations are not affected.

Store another does not change the best point

If you measure or key in a point with a name that already exists in the database, you can choose to store both points in the database, and both are transferred with the job. The Trimble Survey Controller search rules ensure that the point with the highest class is used for calculations. If there are two points of the same class,

the **first** is used.

Averaging overwrites another average

If you measure a point and use a name that already exists in the current job, you can choose to average all points of that name. To store the observation and an averaged grid coordinate, select *Average*. Where an averaged position of that name already exists, the new averaged position will overwrite the existing averaged position. Averaged points have a coordinate classification. Coordinates have a higher classification than observations, so the stored averaged position is used in preference to any observations. You can also choose to Auto-average when the point is within tolerance. For more information, see [Averaging](#).

Assigning control class to a point

Control class is the highest classification that you can give to a point. Any high-accuracy point that you use as a fixed standard in a job can be a control point.

If you specify control search class when you key in the coordinates for a point, you can be sure that those coordinates will not change until you key in another point of the same name and the same search class (control) and choose to overwrite the first point.

The Trimble Survey Controller software never elevates measured points to control class. This is because measured points have measurement errors and may change or be measured again during the course of the job. If the keyed-in point "CONTROL29" is control class, generally you would not want the coordinates of that point to change. A control class point is held fixed for the job.

The Trimble Survey Controller software can measure **observed** control points, but it does not give them control classification. This is because, in calibration, the measured point often has the same name as the keyed-in control point. This makes it easier to set up the calibration. It also makes it easier to manage your data, for example, if you know that all references to point "CONTROL29" on the ground are also references to point "CONTROL29" in the database.

Using low class points as backsights

If you use a low class point, such as an 'As-staked' or 'Check' class point for a backsight, the following message appears:

"Backsight point has a low classification. Before continuing, key in a backsight coordinate to ensure that coordinates can be calculated."

The Search rules resolve the coordinates of dependant points, and then determine the best point. While these rules work extremely well in most situations, occasionally a loop in the search rules can occur that results in observations failing to produce coordinates when expected.

This can occur when an 'As-staked' observation class point, or a 'Check' observation class point is used as a backsight point.

The Trimble Survey Controller software then warns you that a low class point is being used as a backsight. You can ignore this message, and your data should still process correctly in the office software. However, you may not be able to view coordinates for subsequent observations, and you may not be able to see the points in the map.

To avoid this problem, enter a Keyed-in coordinate for the backsight point **before** completing the station setup:

1. Tap *Key in / Points*.
2. Enter the name for the backsight point. When a message appears saying that the point already exists, tap *OK*.
3. The coordinates for the point appear. Tap *Store*.
4. In the *Duplicate point* form that appears, set the *Action* to *Store another* and then tap *Enter*.

A coordinated keyed-in point for the backsight has now been stored. Coordinates have a higher class than observations, so your backsight point no longer has a low class, and all observations from this station are now coordinated.

Appendix A

Calculations performed by the Trimble Survey Controller software

Introduction

This appendix outlines some of the calculations performed by the Trimble Survey Controller software.

- [Transformations applied to GPS positions](#)
- [Ellipsoid calculations](#)
- [Conventional instrument calculations](#)
- [Area calculations](#)

Transformations applied to GPS positions

For RTK surveying, coordinate transformations are required so that one set of coordinates (GPS positions) can be represented in terms of another (grid positions), and vice versa.

Tip - To see an example of converting measurements to grid coordinates using the Trimble Survey Controller software, click [here](#) and then select the *Calibration* section.

This section provides an overview of the management and application of coordinate transformations using the Trimble Survey Controller software. It describes how to apply a datum transformation and map projection, and horizontal and vertical adjustments.

With the Trimble Survey Controller software, the site calibration process defines transformation parameters derived from a set of points. This set of points is coordinated in terms of two systems:

- WGS-84 Latitude, Longitude, Height (LLH) geodetic coordinates
- A local system with project-specific Northing, Easting, Elevation (NEE) grid coordinates

The following diagram shows the order of calculations performed when a calibration is calculated.

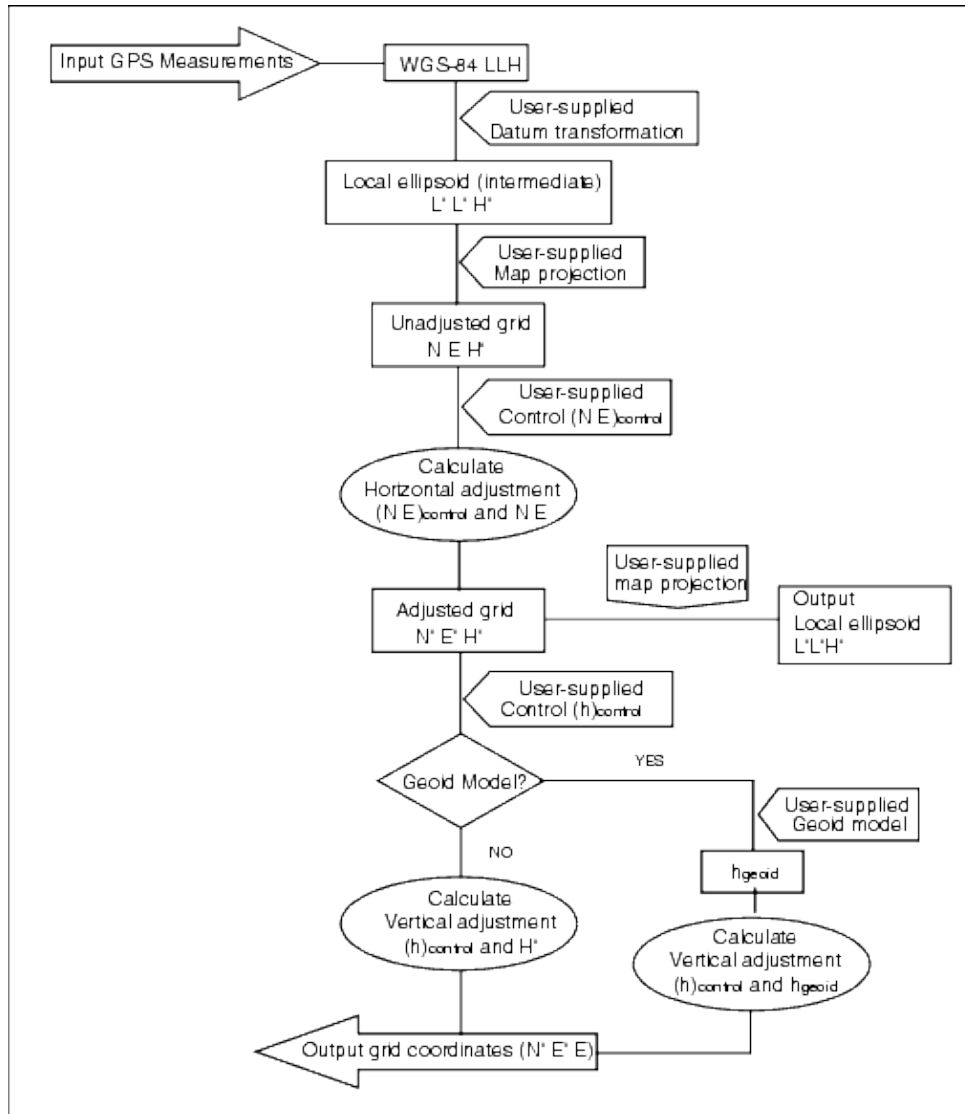

The formulae used in the above flow diagram are detailed below.

Transforming WGS-84 ECEF to WGS-84 LLH

When GPS signals are processed by a receiver, they yield Earth-Centered-Earth-Fixed (X, Y, Z) coordinates, which must then be transformed to more meaningful geodetic coordinates (ϕ , λ , H).

Here, ϕ represents the geodetic latitude, λ is the longitude, and H is the perpendicular height above the WGS-84 ellipsoid.

First we define:

$$e^2 = 2f - f^2$$

$$N = \frac{r}{\sqrt{1 - e^2 \sin^2(\phi)}}$$

where f is the flattening value for the source ellipse and r is the semi-major axis.

The values of the ECEF coordinates are:

- $X = (N + H) \cdot \cos(\phi) \cdot \cos(\lambda)$
- $Y = (N + H) \cdot \cos(\phi) \cdot \sin(\lambda)$
- $Z = [N(1 - e^2) + H] \cdot \sin(\phi)$

The inverse problem (that of transforming ECEF coordinates to ϕ , λ , and H) is solved by using an iterative procedure. The values of e^2 and N now use the destination ellipsoid flattening and semi-major axis values:

$$\phi = \tan^{-1}\left(\frac{Z}{\sqrt{X^2 + Y^2}}(1 - e^2)\right)$$

then iterate

$$\phi = \tan^{-1}\left(\frac{Z + e^2 N \sin(\phi)}{\sqrt{X^2 + Y^2}}\right)$$

$$\lambda = \tan^{-1}\left(\frac{Y}{X}\right)$$

if $45^\circ\text{S} < \phi < 45^\circ\text{N}$

$$H = \frac{\sqrt{X^2 + Y^2}}{\cos(\phi)} - N$$

or if $\phi > 45^\circ\text{N}$ or $\phi < 45^\circ\text{S}$

$$H = \frac{Z}{\sin(\phi)} - N(1 + e^2)$$

Datum Transformation

A datum transformation provides the necessary parameters for converting from one geodetic coordinate system to another.

The Trimble Survey Controller software can apply a predefined three- or seven-parameter datum transformation. It can also calculate a three-parameter datum transformation given points coordinated in WGS-84 and local L'L'H'.

$$X = T + kRX'$$

where X' is a matrix of 3-D Cartesian ECEF coordinates or Cartesian local coordinates, T is a matrix of translation parameters, k is a scalar, and R is a rotation matrix. In most cases, X' is measured and T , k , and R are user-specified.

To calculate a three-parameter datum transformation, pairs of WGS-84 LLH and local L'L'H' coordinates are needed.

In the trivial one point case, the three translation parameters are just the vector components of the ECEF vector that connect the ECEF pair derived from the WGS-84 LLH and the local L'L'H'.

In the non-trivial case, the translation parameters are the vector components of the average vector. This is represented as:

$$AX + W = 0$$

where the solution

$$X = \begin{bmatrix} \Delta X \\ \Delta Y \\ \Delta Z \end{bmatrix}$$

and

$$W = \begin{bmatrix} X_1 - X'_1 \\ Y_1 - Y'_1 \\ Z_1 - Z'_1 \\ X_2 - X'_2 \\ Y_2 - Y'_2 \\ Z_2 - Z'_2 \\ \vdots \end{bmatrix}$$

where X_n is the value of the ECEF coordinate derived from the local L'L'H' of the nth 3-D point in the list, and X'_n is the X value of the ECEF coordinate derived from the WGS-84 LLH of the nth 3-D point and

$$A = \begin{bmatrix} 1 & 0 & 0 \\ 0 & 1 & 0 \\ 0 & 0 & 1 \\ 1 & 0 & 0 \\ 0 & 1 & 0 \\ 0 & 0 & 1 \\ \vdots & \vdots & \vdots \end{bmatrix}$$

is called the Molodensky matrix.

For more information, refer to *GPS Satellite Surveying* by A. Leick (John Wiley & Sons, 1995).

Map Projection

A map projection defines the relationship between the local ellipsoidal surface (L'L'H') and a plane. Generally, map projection parameters are based on a local conformal mapping model.

For more information about map projections, please refer to the *Map Projections--A Working Manual* by J.P. Snyder (U.S. Geological Survey Professional Paper 1295, U.S. Government Printing Office, Washington, 1987).

For nearly all projection types used in the Trimble Survey Controller software, the height component of a projected coordinate is just the height above or below the datum at that point. For a plane projection, however, the definition includes an ellipsoidal height and a projected surface elevation at the origin point.

Horizontal Adjustment

It may be necessary to minimize the discrepancy between local fixed control coordinates (NEcontrol) and projected grid coordinates (N'E'). The horizontal adjustment solves parameter translations in north and east (ΔN , ΔE), a rotation ϕ , and a scale factor k using two different sets of plane coordinates--one converted from measurements in the field, and the other from a control list. Where the Trimble Survey Controller software generates its own three-parameter datum transformation, it is necessary to provide for scaling and rotation. This is done by a horizontal adjustment.

The following diagram shows the transformation between two coordinate systems.

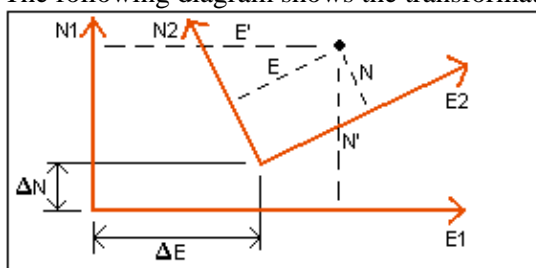

Coordinate systems for a horizontal adjustment

The Trimble Survey Controller software minimizes the discrepancy between local NE control and NE values derived using GPS observations and a datum transformation and map projection. It does this by performing a plane horizontal least-squares adjustment with no weighting.

In the trivial one point case, the translation parameters are just the Northing and Easting components of the vector between the two coordinated values. The scale factor is one, and the rotation value is zero.

For two or more points, calculation of horizontal adjustment uses a simple four-parameter transformation. This solves for two translations (ΔN , ΔE), a rotation (ϕ), and a scale factor (k) between coordinate pairs.

The geometry between the two coordinate systems results in two transformation equations:

- $N' = aN + bE + \Delta N$
- $E' = -bN + aE + \Delta E$

where $a = k \cos \phi$ and $b = k \sin \phi$ are used to simplify the matrix representation, and ΔN and ΔE represent the shifts of the N and E axis in the N' and E' system.

Common points in both coordinate systems are used in a least-squares adjustment to solve the four unknown parameters (a , b , ΔE , and ΔN).

Once estimates of a and b are determined, the rotation and scale between the two systems is calculated by:

$$\phi = \tan^{-1}\left(\frac{a}{b}\right) \text{ and } k = \sqrt{a^2 + b^2}$$

For more information about horizontal adjustment, please refer to *Observations and Least Squares* by E. Mikhail (John Wiley & Sons, 1982).

Vertical Adjustment

The Trimble Survey Controller software determines a vertical adjustment using least-squares with no weighting. This adjustment requires measured WGS-84 heights and control elevations.

In the trivial one-point case, the adjustment consists of a constant height shift only. For two or more points, a tilt in north and east are also computed.

The inclined plane parameters are determined by solving the matrix equation:

$$AX = B$$

where the solution

$$X = \begin{bmatrix} \Delta H \\ \Delta E \\ \Delta N \end{bmatrix}$$

the components being the constant height shift and tilt east and north (in terms of a height shift per unit distance east or north), and the design matrix

$$A = \begin{bmatrix} 1 & E_1 - E_1 & N_1 - N_1 \\ 1 & E_2 - E_1 & N_2 - N_1 \\ \vdots & \vdots & \vdots \\ 1 & E_n - E_1 & N_n - N_1 \end{bmatrix}$$

where E_n N_n are the coordinates of the nth point as derived from the WGS-84 data set.

E_1 N_1 are the coordinates of the origin point of the adjustment. (The origin point can be any one of the n points.)

$$B = \begin{bmatrix} H'_1 - H_1 \\ H'_2 - H_2 \\ \vdots \\ H'_n - H_n \end{bmatrix}$$

where $H'_n - H_n$ is the difference in elevation between the keyed in value for the nth point and the value derived from the WGS-84 data set.

Ground Scale Factor

In the Trimble Survey Controller software, you can define a *Project height* when you create a *No*

projection/no datum job. The project height is used after you perform a site calibration to compute a scale factor for the projection, so that ground coordinates are computed at elevation.

The projection scale factor is calculated as follows:

$$SF = \frac{R+h}{R}$$

and

$$R = \frac{a}{\sqrt{1 - e^2 \sin^2(\phi)}}$$

where:

SF	scale factor of projection
R	ellipsoidal radius
h	average elevation (reference elevation)
a	semimajor axis
e ²	eccentricity ²
φ	origin latitude of projection

Geoid Model

The Trimble Survey Controller software can use a geoid model to provide orthometric heights from measured (by GPS) WGS-84 heights.

Geoid model is one of the options in the *Vertical adjustment* field. (The other options in this field are *No adjustment*, *Inclined plane*, *Geoid model/Inclined plane*.)

If you select Geoid model and you do not perform an in-field calibration, the elevation values displayed by the Trimble Survey Controller software represent the unadjusted elevation above the defined geoid using the relationship:

$$h_{\text{geoid}} = H - N$$

where:

h _{geoid}	the unadjusted elevation above the geoid
H	the measured GPS height above the ellipsoid
N	the geoid ellipsoidal separation, derived from a geoid model

If you select *Geoid model* and then perform an in-field calibration, the Trimble Survey Controller software computes the calibration parameters using hcontrol and hgeoid as inputs, so that the geoid model is inclined to fit the local control elevations. The method of vertical adjustment becomes *Geoid/Inclined plane*.

Ellipsoid Calculations

The ground and ellipsoid distances in the Trimble Survey Controller software are calculated parallel to the ellipsoid. The equations used for these calculations are based on the Robbins ellipsoid geometry formulas. These formulas (by Dr A.R. Robbins) are in the *Empire Survey Review* No. 125, 1962. They are accurate to better than 20 mm over distances of 1,500 km. The errors can reach 16 meters at 4,500 km and more than 2,000 meters at 9,000 km.

Conventional Instrument Calculations

The following diagram labels the observations and corrections that are applied when you use the Trimble Survey Controller software with a conventional instrument.

Note - Interim corrections are not shown in the diagram. They are enclosed in square brackets in the table that follows.

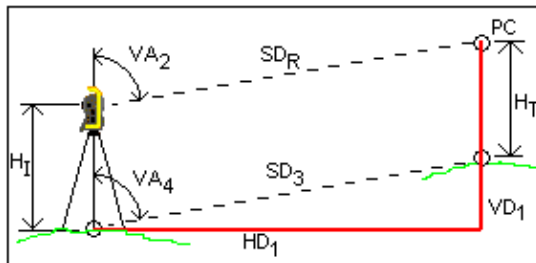

Correction variables used in conventional instrument calculations

Where:

VA ₂	Vertical angle from conventional instrument. The Trimble Survey Controller software assumes that the conventional instrument applies any corrections for collimation and tilt.
[VA ₃]	Vertical angle corrected for curvature and refraction
VA ₄	Vertical angle corrected for curvature and refraction, instrument and target heights
SD _R	Slope distance from EDM
[SD ₁]	Slope distance corrected for prism constant (PC)
[SD ₂]	Slope distance corrected for prism constant and PPM
SD ₃	Slope distance corrected for prism constant, PPM, instrument and target heights
HD ₁	Horizontal distance between instrument point and target point
VD ₁	Vertical distance between instrument point and target point
H _I	Height of instrument
H _T	Height of target
PC	Prism constant

Prism Constant Correction

The prism constant is applied to all slope distances. It is usually negative, but can be positive.

$$SD_I = SD_R + PC$$

where:

SD _R	measured (raw) slope distance
SD _I	resultant slope distance
PC	prism constant

PPM Correction

The parts per million (PPM) correction is applied to the slope distance after being corrected for the prism constant (see above). PPM depends on pressure and temperature.

$$D_2(P, T) = SD_I \left[J - \frac{N \cdot P}{273.16 + T} \right] \cdot 10^{-6}$$

where:

P	air pressure in millibars
T	temperature in °C
J & N	constants <i>supplied by the EDM manufacturer</i>

The following table lists some manufacturers of conventional instruments, and the J and N constants that the Trimble Survey Controller software uses to compute the PPM correction for those instruments.

PPM Constants for Conventional Instruments

Manufacturer of conventional instruments	J constant	N constant
Trimble VX/S Series	from instrument	from instrument
Trimble 5600	274.41	79.39
Trimble 3300/3600	278.77	80.653
Trimble TTS300/500	270.0	79.167
Sokkia SET	279.0	79.400
Topcon	279.7	79.600
Geotronics 400/600	275.0	79.550
Leica	282.0	79.400
Zeiss Elta2/Elta3/Elta4	255.0	79.100
Zeiss Elta C	281.8	79.391
Pentax	279.0	79.400

Nikon	275.0	79.5065
-------	-------	---------

Note - The Trimble VX/S Series instrument J and N constants that are read from the instrument can be viewed in an exported JobXML file.

Note - The J constant value is the refractive index of the instrument. The N constant value is for use with pressure measurements in millibars. In the .dc file, the value is converted to one that can be used with pressure measurements in mmHg.

Curvature and Refraction Correction

The curvature and refraction correction is applied to vertical angles according to the coefficient of refraction that you set.

$$VA_3 = VA_2 - \left[\frac{(1-k)SD_3}{2R} \right] \cdot \frac{180}{\pi} \text{ (Curvature and refraction correction)}$$

where:

k	coefficient of terrestrial refraction, selected in the <i>Corrections</i> field in the survey style
R	approximate spheroid radius = 6378137m. (WGS-84 semi-major axis)
SD ₃	slope distance, from equation - Point to point slope distance
VA ₂	vertical angle, from instrument
VA ₃	corrected vertical angle

Instrument and Target Height Reduction

The corrected vertical angle (VA₄) from the instrument to the target is:

$$VA_4 = \tan^{-1} \left[\frac{SD \sin VA}{SD_2 \cos VA_3 + H_I - H_T} \right]$$

where:

H _I	instrument height
H _T	target height
SD ₂	slope distance
VA ₃	vertical angle, from equation - Curvature and refraction correction
VA ₄	corrected vertical angle

The slope distance from source point to target point (SD₃) is given by the following:

$$SD_3 = \frac{SD_2 \sin VA_3}{\sin VA_4} \text{ (Point to point slope distance)}$$

Face 1/Face 2 Determination

This section describes how the Trimble Survey Controller software reduces Face 2 readings to Face 1 readings in order to perform calculations. It does this automatically.

The observed raw vertical angle is used to determine whether an observation is Face 1 or Face 2:

- If the vertical angle is not present the observation is assumed to be Face 1.
- If the vertical angle is in the range 0° to 180°, the observation is Face 1.
- If the vertical angle is in the range 180°-360°, the observation is Face 2.

Orientation Correction

To orient circle readings so that they become azimuths, an orientation correction is applied. The orientation correction is the difference between the backsight circle reading and the backsight azimuth. This term is applied to all the other observations (circle readings) at a station.

The formula is:

$$Az_x = HA_x + (Az_B - HA_B) \text{ (Orientation correction)}$$

where:

Az_x	azimuth to any point X
HA_x	horizontal observation to any point X
Az_B	actual backsight azimuth ('reference azimuth')
HA_B	observed backsight circle reading

Slope Reduction

The horizontal and vertical components of an observation (HD_1 and VD_1) are found from the vertical angle and slope distances by:

$$HD_1 = SD_3 \sin VA_4$$

$$VD_1 = SD_3 \cos VA_4$$

where:

HD_1	horizontal distance
VD_1	vertical distance
VA_4	zenith angle
SD_3	slope distance

Coordinate Calculation

Coordinates of a target point are calculated from observations and the coordinates of the instrument point using:

$$N_2 = N_1 + HD_1 \cos Az_1$$

$$E_2 = E_1 + HD_1 \sin Az_1$$

$$Z_2 = Z_1 + VD_1$$

where:

N_1, E_1, Z_1	Northing, Easting, Elevation of instrument point
N_2, E_2, Z_2	Northing, Easting, Elevation of target point
HD_1	horizontal distance
VD_1	vertical distance
Az_1	from equation - Orientation correction .

Mean Turned Angle Calculations

When the software calculates the mean turned angle and the mean distance for a point, it also calculates standard errors as follows:

For the angles, the standard error of the mean of a set of measurements formula is used:

$$\sigma = \sqrt{\frac{\Sigma v^2}{n(n-1)}}$$

For distances, the standard error of the set of measurements formula is used:

$$\sigma = \sqrt{\frac{\Sigma v^2}{(n-1)}}$$

Resection Calculation

The resection calculation is a least-squares calculation that uses all available data.

Observations to the same point taken on different faces are treated as separate observations. However, the results are the same as those gained from using meaned (averaged) observations.

The residuals are given for each *point*, not each observation.

The formula used for the standard errors is as follows:

$$\sigma = \frac{(\sqrt{\Sigma v^2})}{(n-1)}$$

Traverse Calculation

This section shows the formulae that the software uses when it calculates a traverse.

Compass adjustment

The Compass adjustment distributes the error in proportion to the length of the traverse lines. The formulae are as follows:

$$\text{Northing adjustment} = \frac{D}{\Sigma D} \times \text{Northing misclosure}$$

where:

D	horizontal distance
ΣD	sum of the horizontal distances in the traverse

$$\text{Easting adjustment} = \frac{D}{\Sigma D} \times \text{Easting misclosure}$$

where:

D	horizontal distance
ΣD	sum of the horizontal distances in the traverse

Transit adjustment

The Transit adjustment distributes the error in proportion to the northing and easting of each traverse point.

$$\text{Northing adjustment} = \frac{\Delta N}{\Sigma \Delta N} \times \text{Northing misclosure}$$

where:

ΔN	change in northing for the traverse line
$\Sigma \Delta N$	sum of the changes in northings of all the traverse lines

$$\text{Easting adjustment} = \frac{\Delta E}{\Sigma \Delta E} \times \text{Easting misclosure}$$

where:

ΔE	change in easting for the traverse line
$\Sigma \Delta E$	sum of the changes in eastings of all the traverse lines

Angular adjustments

There are three options for distributing the angular error in a traverse:

- Proportional to distance--the error is distributed among the angles based on the sum of the inverses of the forward and back traverse distances for each point. The formula used is as follows:

$$A_a = \frac{\frac{1}{to\ dist} + \frac{1}{from\ dist}}{\sum \left(\frac{1}{to\ dist} + \frac{1}{from\ dist} \right)} \times A_m$$

where:

A _a	Angular adjustment
A _m	Angular misclose

- Equal proportions--the error is distributed evenly among the angles in the traverse.
- None--the error is not distributed.

Elevation adjustments

There are three options for distributing the elevation error in a traverse:

- Proportional to distance--the error is distributed in proportion to the length of the traverse line to the point.
- Equal proportions--the error is distributed evenly among the traverse lines.
- None--the error is not distributed.

Standard Errors Recorded With Conventional Observations

Each conventional observation that is recorded in the job file has standard errors associated with it. The standard errors that are recorded with the observations are determined as follow:

- For a single observation to a point (for example, Measure topo) the standard error values assigned to the observation are the instrument standard error values (a-priori values). This is because there is nothing else that the standard errors can be determined from.
- For an averaged observation, the standard deviations that are reported during the measurement process indicate the precision of the instrument, but do not indicate its accuracy. If the standard deviation of any of the measurement components (a-posteriori value) exceeds the equivalent instrument standard error value, then this standard deviation value is recorded with the observation. However, any standard deviation values that are below the instrument standard error value are replaced by the instrument standard error (a-priori) value when the observation is stored. This ensures that the recorded standard errors indicate the instrument accuracy rather than the precision of a given observation.
- For rounds measurements (Rounds, Resection, and Station Setup Plus), the MTA (Mean Turned Angle $\bar{\alpha}$) observations record the a-posteriori standard errors computed from the individual observations that contribute to the MTA.

Area Calculations

The area in *Cogo / Compute area*, is calculated at the average elevation of all the points when the *Distances* field is set to Ground. Average elevation is calculated as follows:

calculate

$$\bar{h} = \frac{\sum h_i}{N}$$

then

$$\left(\frac{\bar{h} + R}{R}\right)^2 \times \text{area at sea level}$$

where:

N	number of stations
\bar{h}	average elevation
R	ellipsoidal radius

Glossary

Glossary

This topic explains some of the terms used in this Help.

almanac	Data, transmitted by a GPS satellite, that includes orbit information on all the satellites, clock correction, and atmospheric delay parameters. The almanac facilitates rapid SV acquisition. The orbit information is a subset of the ephemeris data with reduced precision.
Angles and distance	Measurement of horizontal and vertical angles and a slope distance.
Angles only	Measurement of horizontal and vertical angles.
Anti-Spoofing (AS)	A feature that allows the U.S. Department of Defense to transmit an encrypted Y-code in place of P-code. Y-code is intended to be useful only to authorized (primarily military) users. Anti-Spoofing is used with Selective Availability to deny the full precision of GPS to civilian users.
Autolock	The ability to lock onto and track a target.
automated rounds	The process of automatically measuring a multiple observations to observed points.
autonomous positioning	The least precise form of positioning that a GPS receiver can produce. The position fix is calculated by one receiver from satellite data alone.
azimuth	Horizontal direction relative to a defined coordinate system.
Backsight	Point with known coordinates or known azimuth from the instrument point that is used to orientate the instrument during station setup.
base station	In a GPS survey, you observe and compute baselines (the position of one receiver relative to another). The base station acts as the position from which all unknown positions are derived. A base station is an antenna and receiver set up on a known location specifically to collect data to be used in differentially correcting rover files.
baud	A unit of data transfer speed (from one binary digital device to another) used in describing serial communications; generally one bit per second.
C/A (Coarse Acquisition) code	A pseudorandom noise (PRN) code modulated onto an L1 signal. This code helps the receiver compute the distance from the satellite.
change face	Turn a servo instrument from the face 1 observing face to face 2.
CMR	Compact Measurement Record. A satellite measurement message that is broadcast by the base receiver and used by RTK surveys to calculate an accurate baseline vector from the base to the rover.
constellation	A specific set of satellites used in calculating positions: three satellites for 2D fixes, four satellites for 3D fixes. All satellites visible to a GPS receiver at one time. The optimum constellation is the constellation with the lowest PDOP. See also PDOP .
construction offsets	A specified horizontal and/or vertical offset distance to enable equipment

	to operate without disturbing construction stakes.
Construction point	A point that is measured using the "quick fix" option in COGO.
curvature and refraction	Correction to the measured vertical angle for the curvature of the earth and the refraction caused by the earth's atmosphere.
data message	A message, included in the GPS signal, that reports on the location and health of the satellites as well as any clock correction. It includes information about the health of other satellites as well as their approximate position.
datum	See geodetic datum.
design code	The code name given to the design point.
design name	The name given to the design point.
Differential Positioning	Precise measurement of the relative position of two receivers tracking the same satellites simultaneously.
Direct Reflex (DR)	Type of EDM that can measure to non reflective targets.
DOP (Dilution of Precision)	An indicator of the quality of a GPS position. DOP takes into account the location of each satellite relative to other satellites in the constellation, as well as their geometry relative to the GPS receiver. A low DOP value indicates a higher probability of accuracy. Standard DOPs for GPS applications are: - PDOP - Position (three coordinates) - RDOP - Relative (Position, averaged over time) - HDOP - Horizontal (two horizontal coordinates) - VDOP - Vertical (height only) - TDOP - Time (clock offset only)
Doppler shift	The apparent change in frequency of a signal caused by the relative motion of satellites and the receiver.
DTM	Digital Terrain Model. An electronic representation of terrain in three dimensions.
dual-frequency	GPS receiver that uses both L1 and L2 signals from GPS satellites. A dual-frequency receiver can compute more precise position fixes over longer distances and under more adverse conditions because it compensates for ionospheric delays.
Dual-prism offset	Measurement of horizontal and vertical angles and a slope distance to two prisms located on one prism pole for the purpose of positioning an obstructed point.
Earth-Centered-Earth-Fixed (ECEF)	A cartesian coordinate system used by the WGS-84 reference frame. In this coordinate system, the center of the system is at the earth's center of mass. The z axis is coincident with the mean rotational axis of the earth and the x axis passes through 0° N and 0° E. The y axis is perpendicular to the plane of the x and z axes.
eccentric object	Measurement of horizontal and vertical angles and a slope distance to the face of a radial object (for example, power pole). An additional horizontal angle is observed to the side of the object to calculate the radius and thus position the center of the object.
EGNOS	European Global Navigation Overlay Service . A satellite-based system that broadcasts GPS correction information.

elevation	Height above mean sea level. Vertical distance above the geoid.
elevation mask	The angle below which Trimble recommends that you do not track satellites. Normally set to 10 degrees to avoid interference from buildings and trees as well as ground multipath errors.
ellipsoid	A mathematical model of the earth formed by rotating an ellipse around its minor axis.
ephemeris	The current satellite position predictions, transmitted in the data message.
epoch	The measurement interval of a GPS receiver. The epoch varies according to the survey type: - for real-time surveys it is set at one second - for postprocessed surveys it can be set to a rate of between one second and one minute
Face 1 (F1)	Observing position of an instrument where the vertical circle is commonly on the left hand side of the telescope.
Face 2 (F2)	Observing position of an instrument where the vertical circle is commonly on the right hand side of the telescope.
feature codes	Simple descriptive words or abbreviations that describe the features of a point. For more information, refer to the Help
fixed solution	Indicates that the integer ambiguities have been resolved and a survey is initialized. This is the most precise type of solution.
float solution	Indicates that the integer ambiguities have not been resolved, and that the survey is not initialized.
FSTD (fast standard)	The method of measuring one distance and one angle to coordinate a point.
GDOP	Geometric Dilution of Precision. The relationship between errors in user position and time, and errors in satellite range. See also DOP .
GENIO	GENERIC Input Output file exported by a number of road design software packages that defines a road as a series of strings. See also String .
geodetic datum	A mathematical model designed to fit part or all of the geoid (the physical earth's surface).
geoid	The surface of gravitational equipotential that closely approximates mean sea level.
GPS	Global Positioning System. Based on a constellation of 24 operational satellites orbiting the earth at a high altitude.
GPS time	A measure of time used by the NAVSTAR GPS system.
H. Angle offset	Measurement of vertical angle and slope distance. Horizontal angle is then measured separately, usually to an obstructed point.
H. Angle only	Measurement of horizontal angle.
HDOP	Horizontal Dilution of Precision. See also DOP .
Helmert adjustment	The Helmert adjustment provides an alternative method for computing a resection setup. The Helmert adjustment is essentially the same adjustment as that used to compute a horizontal adjustment in a GPS calibration.
horizontal circle	Graduated or digital disc from which the horizontal angle is measured

instrument height	Height of the instrument above the instrument point.
instrument point	Point that the instrument is occupying.
integer ambiguity	The whole number of cycles in a carrier phase pseudorange between the GPS satellite and the GPS receiver.
ionosphere	The band of charged particles 80 to 120 miles above the earth's surface. The ionosphere affects the accuracy of GPS measurements if you measure long baselines using single-frequency receivers.
K factor	The K factor is a constant defining a vertical curve in a road definition. $K = L/A$. where: L is the length of the curve A is the algebraic difference between the incoming and outgoing slopes in %
L1	The primary L-band carrier used by GPS satellites to transmit satellite data. The frequency is 1575.42 MHz. It is modulated by C/A code, Pcode, or Y-code, and a 50 bit/second navigation message.
L2	The secondary L-band carrier used by GPS satellites to transmit satellite data. The frequency is 1227.6 MHz. It is modulated by Pcode or Y-code, and a 50 bit/second navigation message. Block IIR-M and later GPS satellites will transmit an additional signal on L2 called L2C.
measurement modes: Standard (STD), Fast Standard (FSTD), Tracking (TRK)	Angles are measured and averaged as one distances is measured. STD mode is indicated by an S next to the instrument icon on the status bar. One angle and one distance are measured. FSTD mode is indicated by an F next to the instrument icon on the status bar. Angles and distances are continually measured. TRK mode is indicated by a T next to the instrument icon on the status bar.
multipath	Interference, similar to ghosting on a television screen. Multipath occurs when GPS signals traverse different paths before arriving at the antenna.
Neighborhood Adjustment	A coordinate adjustment that is applied to conventional surveys with multiple backsights or jobs with a GPS site calibration. During station setup plus, resection or GPS site calibration, residuals are calculated for each observed control point. The calculated distances from each new point to the control points used in the station setup or calibration are used to determine the coordinate adjustment to be applied to the new point.
NMEA	A standard, established by the National Marine Electronics Association (NMEA), that defines electrical signals, data transmission protocol, timing, and sentence formats for communicating navigation data between marine navigation instruments.
NTRIP	Networked Transport of RTCM via Internet Protocol
P-code	The 'precise' code transmitted by the GPS satellites. Each satellite has a unique code that is modulated onto both the L1 and L2 carrier waves.
parity	A form of error checking used in binary digital data storage and transfer. Options for parity checking include Even, Odd, or None.
PDOP	Position Dilution of Precision, a unitless figure of merit expressing the relationship between the error in user position and the error in satellite position.

PDOP mask	The highest PDOP value at which a receiver will compute positions.
postprocess	To process satellite data on a computer after it has been collected.
PPM	Parts per million correction that is applied to measured slope distances to correct for the affects of the earth's atmosphere. PPM is determined using observed pressure and temperature readings together with specific instrument constants.
Prism constant	Distance offset between the center of a prism and the point being measured.
projection	Used to create flat maps that represent the surface of the earth or parts of that surface.
QC records	Quality Control records. With precise positioning applications, this receiver option lets you process RTCM104 corrections and satellite data in real time to provide position precision statistics.
ratio	During initialization, the receiver determines the integer number of wavelengths between each satellite and the GPS antenna phase center. For a particular set of integers, it works out the probability that this is the correct set. The receiver then calculates the ratio of the probability of correctness of the currently-best set of integers to the probability of correctness of the next-best set. A high ratio indicates that the best set of integers is much better than any other set. (This gives us confidence that it is correct.) The ratio must be above 5 for New Point and OTF initializations.
RDOP	Relative Dilution of Precision. See also DOP .
reference station	See base station .
refline	The process of establishing the position of an occupied point relative to a baseline by taking measurements to two known or unknown points.
resection	The process of establishing the position of an occupied point by taking measurements to two or more known points.
RMS	Root Mean Square. This is used to express the accuracy of point measurement. It is the radius of the error circle within which approximately 70% of position fixes are to be found.
RMT	Remote target
rounds	Conventional observation method of multiple observations to multiple points.
rover	Any mobile GPS receiver and field computer collecting data in the field. The position of a roving receiver can be differentially corrected relative to a stationary base GPS receiver.
RTCM	Radio Technical Commission for Maritime Services, a commission established to define a differential data link for the real-time differential correction of roving GPS receivers. There are two types of RTCM differential correction messages, but all Trimble GPS receivers use the newer Type 2 RTCM protocol.
RTK	Real-time kinematic, a type of GPS survey.
single-frequency	

	A type of receiver that only uses the L1 GPS signal. There is no compensation for ionospheric effects.
Single dist. Offset	Measurement of horizontal and vertical angles and a slope distance. Plus additional offset distances to position obstructed points.
SNR	Signal-to-Noise Ratio, a measure of the strength of a satellite signal. SNR ranges from 0 (no signal) to around 35.
Station setup	The process of defining the instrument occupation point and setting the orientation of the instrument to a backsight point or points.
stationing	The distance or interval along a line, arc or road.
String	A string is a series of 3D points joined together. Each string represents a single feature such as a curb line or the centerline of a road.
SV	Satellite Vehicle (or Space Vehicle).
target height	Height of prism above the point being measured.
TDOP	Time Dilution of Precision. See also DOP .
TOW	Time of Week in seconds, from midnight Saturday night/Sunday morning GPS time.
tracking	The process of receiving and recognizing signals from a satellite.
Tracklight	A visible light that guides the prism operator on the correct bearing.
TRK	Tracking mode. Used to measure towards moving targets.
UTC	Universal Time Coordinated. A time standard based on local solar mean time at the Greenwich meridian. See also GPS time.
VDOP	Vertical Dilution of Precision. See also DOP .
vertical circle	Graduated or digital disc from which the vertical angle is measured.
VPI	Vertical Point of Intersection
WAAS	Wide Area Augmentation System. A satellite-based system that broadcasts GPS correction information.
Weight exponent	The Weight exponent is used in the Neighborhood adjustment calculation. When the coordinate adjustment to be applied to a new point is calculated, the calculated distances from each new point to the control points used in the station setup are weighted according to the Weight exponent.
WGS-84	World Geodetic System (1984), the mathematical ellipsoid used by GPS since January 1987. See also ellipsoid .
Y-code	An encrypted form of the information contained in the Pcode. Satellites transmit Y-code in place of Pcode when Anti-Spoofing is in effect.